

JUNIOR JN-1007 PU Kaplı Eldiven

%100 naylon eldiven üzeri Polyüretan kaplıdır. Eli sarımı çok iyi, rahat ve kullanışlı eldivendir. Hassasiyet ve dikkat gerektiren işlerde verimlidir. Kaplama silikon içermediği için hav bırakmaz.

No: 7	27863	0.846 \$
No: 8	27864	0.846 \$
No: 9	27685	0.846 \$
No : 10	27866	0.846 \$



PVC Noktalı Dotlu Örmeye Eldiven 27840 0.70 \$

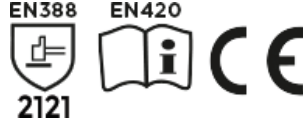

Ekoteks Lateks Kaplı Pamuk Kumaş Eldiven

Yarım nitril kaplamalı, bilek kısmı örgü lastiklidir. Ele tam oturur, sarı renklidir. Montaj, yükleme ve hafif sanayi işlerinde kullanılması uygundur.

No: 9	27844	0.8945 \$
No : 10	27845	0.8945 \$

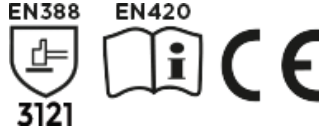

Sarı Taşçı Nitril Eldiven

Kesilmeye mukavemetlidir. Solvent ve yağlara dayanıklı nitril malzeme ile kaplandığından; metal işlerinde çok verimli ve uzun ömürlü olarak kullanılabilir. Nitril duyarlı ve aşınmaya mukavim olduğundan; taş, tuğla ve inşaat işlerinde uzun ömürlü olarak kullanılabilir. Alçak sıcaklıklara dayanıklıdır. Eldiven arka yüzü de %70 kaplanmıştır.

No: 8	27815	
No: 9	27820	0.9445 \$
No : 10	27830	0.9445 \$

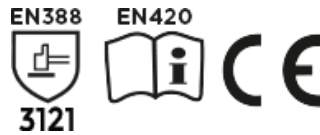

Lacivert Nitril Kaplı Vip Tam Kaplı Eldiven

Otomotiv, taşıma, metal üretim ve ağır sanayi işlerinde kullanılabilir. Soğuk plastik kalıplamalar, çelik boru, profil, saçlarda, teneke ve diğer metal ürünleri, ağır sanayi kablolarında, sokak temizleme ve çöp toplama işlerinde ve yağlı ortamlarda kullanılabilir. Lacivert renkte nitril kaplamadır. Yağ, petrol ve türevlerine karşı dirençlidir. Harika tutuş özelliği ile kavrama işlerini daha kolay ve güvenli kılar. Keskin ve sürtünmeli maddelere karşı dayanıklıdır. Sıvıları tutmayan yüzeyi sebebi ile yağ, kir ve diğer sıvılar eldiven üzerinde kalmaz.

No: 9	27795	1.25 \$
No : 10	27797	1.25 \$



Örmeye Polyester / Naylon Eldiven

13G düz makiba örmesi polyester eldivendir. Gözenekli örgü sayesinde eli terletmez, nefes aldırır. Bileği elastik örgülüdür. Risk gerektirmeyen kuru montaj, paketleme, elektronik,, otomotiv, beyaz eşya, tarım sektöründe kullanımı tercih edilir.

No:9	27803	0.61 \$
------	-------	---------



Örmeye Pamuk Eldiven İnce

10G düz makiba örmesi pamuk eldivendir. Gözenekli örgü sayesinde eli terletmez, nefes aldırır. Bileği elastik örgülüdür. Risk gerektirmeyen kuru montaj, paketleme, elektronik,, otomotiv, beyaz eşya, tarım sektöründe kullanımı tercih edilir.

Çift	27838	0.48 \$
------	-------	---------

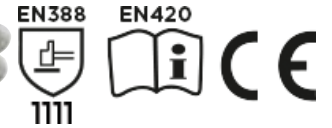

Örmeye Kalın Pamuk Eldiven

düz makina örmesi pamuk eldivendir. Gözenekli örgü sayesinde eli terletmez, nefes aldırır. Bileği elastik örgülüdür. Risk gerektirmeyen kuru montaj, paketleme, elektronik, otomotiv, beyaz eşya, tarım sektörlerinde kullanımı tercih edilir:

Çift	27805	0.53 \$
------	-------	---------

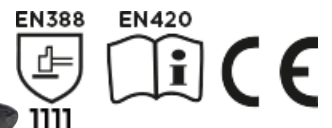

Çift Kat Örmeye Pamuk Eldiven (Siyah) (Beyaz)

7G çift kat makina örmesi pamuk eldivendir. Gözenekli örgü sayesinde eli terletmez, nefes aldırır. Bileği elastik örgülüdür. Risk gerektirmeyen kuru montaj, paketleme, elektronik, otomotiv, beyaz eşya, tarım sektörlerinde kullanımı tercih edilir.

Beyaz - Çift	27810	0.88 \$
Siyah - Çift	27812	0.88 \$



EN420:2003
+A1:2009
EN388:2016
+A1: 2018

CE
4121A

Fullflex Double 3/4 - 0603

Mikro püskürtme 3/4 köpük kaplı polyester örme eldiven
ATG 34425, Ansel 11926

S - No:7	4.36 \$
M - No:8	4.36 \$
L - No:9	4.36 \$
XL - No:10	4.36 \$
XXL - No:11	4.36 \$



EN420:2003
+A1:2009
EN388:2016
+A1: 2018

CE
3131A

Flexifull - 3901

Köpük nitril kaplı polyester örme eldiven

S - No:7	2.57 \$
M - No:8	2.57 \$
L - No:9	2.57 \$
XL - No:10	2.57 \$



EN420:2003
+A1:2009
EN388:2016
+A1: 2018

CE
4121A

Fullflex Double - 0604

Mikro püskürtme tam köpük kaplı polyester örme eldiven
ATG 34426, Ansel 48919

S - No:7	4.55 \$
M - No:8	4.55 \$
L - No:9	4.55 \$
XL - No:10	4.55 \$
XXL - No:11	4.55 \$



Fullflex MG

1/2 köpük nitril kaplı naylon + spandex likra gri iplik örme eldiven, ATG 34600

S - No:7	3.07 \$
M - No:8	3.07 \$
L - No:9	3.07 \$
XL - No:10	3.07 \$

Fullflex G

1/2 köpük nitril kaplı naylon + spandex likra beyaz iplik örme eldiven, ATG 34600

S - No:7	3.07 \$
M - No:8	3.07 \$
L - No:9	3.07 \$
XL - No:10	3.07 \$



EN420:2003
+A1:2009
EN388:2016
+A1: 2018

CE
3131A

Fullform - 5601

Mikro finish su daldırma 3/4 nitril kaplı kırmızı örme eldiven
ATG 34844, Ansel 11818

S - No:7	3.37 \$
M - No:8	3.37 \$
L - No:9	3.37 \$
XL - No:10	3.37 \$

Fullform - 5501

Mikro finish su daldırma 3/4 nitril kaplı koyu gri örme eldiven

S - No:7	3.37 \$
M - No:8	3.37 \$
L - No:9	3.37 \$
XL - No:10	3.37 \$



EN388:2016
+A1:2018
EN ISO 21420:
2020

CE
4X43B

Fullfactor - C-1952

Mikro finish su daldırma 3/4 nitril kaplı, kesilmeye dayanıklı cynema iplik örme eldiven.
ATG 348743, Ansel 48705

S - No:7	6.44 \$
M - No:8	6.44 \$
L - No:9	6.44 \$
XL - No:10	6.44 \$
XXL - No:11	6.44 \$

EN388:2016
+A1: 2018
EN420:2003
+A1:2009

CE
4X42D



Fullfire D-1981 Kesilmeye velsiya Dayanıklı Eldiven

S - No:7	11.88 \$
M - No:8	11.88 \$
L - No:9	11.88 \$
XL - No:10	11.88 \$
XXL - No:11	11.88 \$



EN388:2016
+A1:2018
EN ISO 21420:
2020

CE
4X42E

Fullfactor E-1961

3/4 köpük nitril kaplı naylon eldiven

S - No:7	7.82 \$
M - No:8	7.82 \$
L - No:9	7.82 \$
XL - No:10	7.82 \$
XXL - No:11	7.82 \$



Orjinal Eldiven Full Sarı

Sarı nitril kaplama, örme naylon eldiven

No:9	EL050	2.05 \$
No:10	EL060	2.05 \$

Sarı Dalgalı Nitril Eldiven 3/4

Sarı dalgalı nitril kaplama, pamuk kumaş eldiven

No:9	EL250	2.47 \$
No:10	EL260	2.47 \$

PU Eldiven Extra 1/2

Siyah poliüretan kaplı, örme siyah naylon eldiven

No:7	EL126	0.77 \$
No:8	EL127	0.77 \$
No:9	EL128	0.77 \$
No:10	EL129	0.77 \$

PU Eldiven 1/2

Siyah poliüretan kaplı, örme siyah naylon eldiven

No:7	EL130	0.99 \$
No:8	EL140	0.99 \$
No:9	EL150	0.99 \$
No:10	EL160	0.99 \$



Komfort Eldiven 1/2

Mavi nitril kaplı, mavi örme eldiven

No:9	EL350	2.44 \$
No:10	EL360	2.44 \$

Kesilmeye Dayanıklı Eldiven 1/2

Siyah nitril kaplı, gri kesilmeye dayanıklı örme eldiven

No:10	EL370	4.60 \$
-------	-------	---------

Orjinal Latex Eldiven Full

Lacivert tam latex kaplama üzerine siyah nitril kaplama

No:9	EL070	3.26 \$
No:10	EL080	3.26 \$



1/2 Siyah Nitril Kaplı Kırçıl Gri Örme Naylon Eldiven

EL005	0.74 \$
-------	---------



Kırmızı Lateks Eldiven 1/2

No:9	EL170	1.07 \$
No:10	EL180	1.07 \$

Kırmızı Lateks Pütürlü Eldiven 3/4

No:10	EL190	1.30 \$
-------	-------	---------

1/2 Pütürlü Siyah Lateks Kaplı Kırmızı Örme Eldiven

EL165	0.91 \$
-------	---------



Siyah Yeşil Soft Eldiven 3/4

Siyah nitril kaplı, yeşil örme eldiven

No:9	EL310	2.05 \$
No:10	EL320	2.05 \$

Lıkralı Siyah Montaj Eldiveni 1/2

Siyah nitril kaplı, gri lıkralı örme eldiven

No:9	EL330	2.05 \$
No:10	EL340	2.05 \$

Lıkralı Siyah Montaj Eldiveni 1/2

No:10	MEL270	2.35 \$
-------	--------	---------



Orjinal Eldiven 1/2

Siyah nitril kaplı, sarı örme eldiven

No:9	EL010	1.19 \$
No:10	EL020	1.19 \$

Orjinal Eldiven 1/2

Gri nitril kaplı, gri örme eldiven

No:10	EL030	1.19 \$
-------	-------	---------

Orjinal Eldiven 1/2

Siyah nitril kaplı, yeşil örme eldiven

No:10	EL040	1.19 \$
-------	-------	---------

Gri Nitril Kaplı Örme Beyaz Naylon Eldiven

No:10	EL001	0.70 \$
-------	-------	---------

Sarı Nitril Kaplı Örme Beyaz Naylon Eldiven

No:10	EL002	0.70 \$
-------	-------	---------

Turuncu Nitril Kaplı Örme Beyaz Naylon Eldiven

No:10	EL003	0.70 \$
-------	-------	---------

Siyah 1/2 Nitril Kaplı Örme Kırmızı Naylon Eldiven

No:10	EL004	0.74 \$
-------	-------	---------



Yeşil Pütürlü Eldiven 3/4

No:9	EL290	2.05 \$
No:10	EL300	2.05 \$



Süper Latex Eldiven 1/2

Yeşil latex kaplı, gri örme naylon eldiven

No:9 EL200 1.07 \$
No:10 EL210 1.07 \$

Süper Latex Eldiven 1/2

Yeşil latex kaplı, gri örme naylon eldiven

No:10 EL167 0.91 \$

Süper Latex Eldiven 3/4

Yeşil latex kaplı, gri örme naylon eldiven

No:10 EL220 1.30 \$

Süper Latex Eldiven 3/4

Yeşil latex kaplı, gri örme naylon eldiven

No:10 EL220 1.28 \$



Zebra Eldiven Turuncu-Siyah 1/2

Siyah nitril kaplı, turuncu örme

No:9 EL090 1.41 \$
No:10 EL100 1.41 \$

Zebra Eldiven Mavi 1/2

Siyah nitril kaplı, mavi örme

No:10 EL110 1.41 \$

Zebra Eldiven Turuncu 1/2

Turuncu nitril kaplı, turuncu örme

No:10 EL120 1.41 \$



Zebra Eldiven Extra Naylon 1/2

Sarı nitril kaplı, sarı örme

No:10 EL006 0.93 \$

Zebra Eldiven Extra Naylon 1/2

Turuncu nitril kaplı, turuncu örme

No:10 EL007 0.93 \$

Zebra Eldiven Extra Naylon 1/2

Siyah nitril kaplı, turuncu örme

No:10 EL008 0.93 \$

Zebra Eldiven Extra Naylon 1/2

Siyah nitril kaplı, maviörme

No:10 EL009 0.93 \$



Yeşil Lateks Eldiven 1/2

Yeşil pütürlü lateks kaplı, örme pamuk eldiven

No:10 EL280 1.67 \$



Deri Eldiven Sarı

No:10 EL400 5.55 \$

Takviyeli Deri Eldiven

Tırnak ve avuç takviyeli

No:10 EL410 4.20 \$



Petrolcu Eldiven

Lacivert tam nitril kaplı, konçlu pamuk kumaş eldiven

No:10 EL390 2.65 \$



Argon Kaynak Eldiveni

Beyaz deri eldiven

No:10 EL420 6.80 \$



Uzun Deri Kaynak Eldiveni

35 cm, 14"

EL430

7.05 \$



Çok Amaçlı Ekstra Güçlü Eldiven

S / No:7 - 7.5 küçük	EL434	0.70 \$
M / No:8 - 8.5 orta	EL435	0.70 \$
L / No:9 - 9.5 büyük	EL436	0.70 \$
XL / No:10 - 10.5 çok büyük	EL437	0.70 \$



PU Eldiven 1/2

Siyah poliüretan kaplı, örme siyah naylon eldiven		
No:7	EL130	0.99 \$
No:8	EL140	0.99 \$
No:9	EL150	0.99 \$
No:10	EL160	0.99 \$



Balık Sırtı Desenli Çift Yönlü Siyah Eldiven

M	50 Adet/pk	EL446	9.70 \$
L	50 Adet/Pk	EL447	9.70 \$
XL	50 Adet/Pk	EL448	9.70 \$



Kauçuk Eldiven Turuncu

XL	EL440	1.61 \$
----	-------	---------

Pamuklu Kauçuk Eldiven Turuncu

XL	8299	1.74 \$
----	------	---------



Siyah Kauçuk Eldiven Uzun Pütürlü

XL, 45 cm	EL450	5.20 \$
XL, 60 cm	EL460	5.70 \$



Terminatör Eldiven

Turuncu kaplı beyaz eldiven		
No:10	EL380	1.80 \$

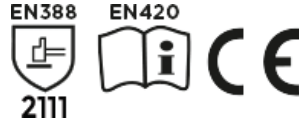

JUNIOR

JN-111/S Yeşil Pütürlü Lateks Kaplı Örmeli Eldiven

Cam işleri için uygundur. Tırnaklı kaplaması sayesinde ıslak ve kuru ortamlarda kusursuz kavrama sağlar.

No:9	27840	1.12 \$
No:10	27841	1.12 \$



JUNIOR

JN-103 Kırmızı Siyah Pütürlü Lateks Kaplı Naylon Eldiven

No:8		0.88 \$
No:9	27840	0.88 \$
No:10	27841	0.88 \$

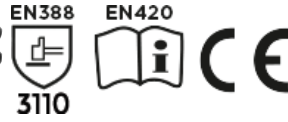

JUNIOR

Doğal Kauçuk Tırtıklı Asit Eldiven

45 cm	4.59 \$
60 cm	4.86 \$

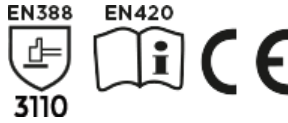

JUNIOR

Doğal Kauçuk Düz Asit Eldiven

45 cm	
60 cm	



JUNIOR

Yeşil Nitril Asit Eldiven

33 cm	1.80 \$
-------	---------

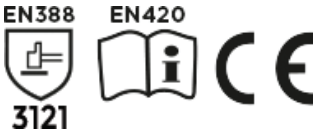

Siyah Nitril Kaplı Örmeli Kırmızı Naylon Eldiven

No:9 - Kırmızı Siyah	0.77 \$
No:10 - Kırmızı Siyah	0.77 \$



Muayene Eldiveni

Pudralı	
S - M - L	175.00 TL/Pk

Latex, Pudrasız	
S - M - L	208.00 TL/Pk

Nitril, Pudrasız Mavi renk (gıda için)	
S - M - L	185.00 TL/Pk

1 Paket / 100 adet



JUNIOR

JN-114 Kuzu Derisi Argon Kaynak Eldiveni

Argon tipi ve hassas kaynak işlerinde kullanıma uygundur. Metal parçaların taşınması, kesilmesi, montaj ve kaplama işlerinde ve metal parçalarda, enjeksiyon kalıplarında, tamirat, madencilik, yük taşıma, bakım, ağır iş makinelerinde kullanıma uygundur. El kısmı yumuşak, keçi ya da bufalo derisinden, konç kısmı ise 1. sınıf yarma deriden üretilmiştir. Isıya dayanıklıdır.

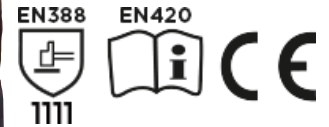

Kot Konçlu Deri İş Eldiveni

Avuç içi 1mm takviyeli deri, üzeri blanket pamuk kumaş ve kalın naylon dikişlidir.

Adet	27781	105.00 TL
------	-------	-----------

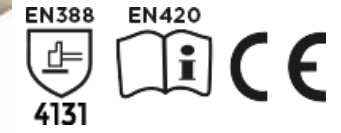

Ekstra Takviyeli Deri İş Eldiveni

1. kalite yarma deri, 1.2-1.3mm deri kalınlığı, içi astarlı kumaş, kalın naylon dikiş ipi, üstü blanket pamuk kumaş, avuç içi 2 kat takviyeli deri, b,leği dıştan lastikli, parmak uçları takviyelidir.

Adet	27780	170.00 TL
------	-------	-----------

Tek Parmak Takviyeli Deri İş Eldiveni

Adet	27782	145.00 TL
------	-------	-----------

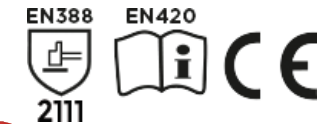

JUNIOR

JN-102 Uzun Konç Deri Kaynak Eldiveni

Genel kaynak işleri için uygundur. Kuru cam işleri, seramik, inşaat, mermer, araç sanayi işlerinde, kaynak yapımında kullanılır. Kaynak yapımında ısıya karşı koruma özelliği bulunur. Dayanıklı sıgır yarma deri malzemeden üretilmiştir. Isı, alev ve sıçrayan kıvılcımlara karşı etkin koruma sağlar. Uzun konç sayesinde ön kol bölgesini korur.

JN102	5.35 \$
-------	---------



S-400 Koruyucu Gözlük

Şeffaf	17.00 TL
Siyah (Ark Kaynak için)	17.00 TL
Mavi (Oksigaz Kaynak için)	17.00 TL
Füme	17.00 TL
Şeffaf 12'li Paket	204.00 TL



S-1551 Quattro Ventilli Koruyucu Gözlük

Şeffaf	60.00 TL
Yedek Gözlük Camı	28.00 TL

S-1551 Quattro Koruyucu Gözlük

Şeffaf	55.00 TL
--------	----------



S-500 Dinamik Koruyucu Gözlük (Spor Gözlük)

Şeffaf	23.00 TL
Siyah Kaynak	23.00 TL
Sarı	23.00 TL
Füme	23.00 TL
Mavi	23.00 TL
Kırmızı	23.00 TL
Yeşil	23.00 TL
Şeffaf Antifog	43.00 TL
Mavi Antifog	43.00 TL
Sarı Antifog (gece görük, kamyoncu gözlüğü)	43.00 TL
Gökkuşáğı Aynalı	43.00 TL
Gümüş Aynalı Antifog	58.00 TL



S-550 Grand Koruyucu Gözlük

Şeffaf	78.00 TL
Gökkuşáğı Aynalı	99.00 TL
Yedek Gözlük Camı	28.00 TL



S-550 Grand Ayarlı Tokalı Koruyucu Gözlük

Şeffaf	83.00 TL
Füme	83.00 TL
Şeffaf Antifog	108.00 TL
Gökkuşáğı Aynalı	108.00 TL
Gümüş Aynalı Antifog	127.00 TL
Yedek Gözlük Camı Antifog	59.40 TL
Şeffaf 12'li Paket	996.00 TL

S-600 Stil Koruyucu Gözlük

Şeffaf	25.00 TL
Füme	25.00 TL
Siyah Kaynak	25.00 TL
Şeffaf Antifog	45.00 TL
Set Çantalı	663.00 TL



S-700 Major Koruyucu Gözlük Üstü Gözlük

Şeffaf	28.00 TL
Füme	28.00 TL
Siyah Kaynak	28.00 TL
Sarı	28.00 TL
Siyah Kaynak Antifog	50.00 TL
Sarı Antifog	50.00 TL
Şeffaf Antifog	50.00 TL
Aynalı Gökkuşáğı	50.00 TL

S-900 Curved Koruyucu Gözlük

Şeffaf Normal	23.00 TL
Füme Normal	23.00 TL
Siyah Kaynak	23.00 TL
Şeffaf Antifog	43.00 TL
Gökkuşáğı Aynalı	43.00 TL
Gümüş Aynalı	58.00 TL





BX-2500 Solo Koruyucu Koruyucu Gözlük
Şeffaf Antifog 110.00 TL
Siyah Antifog 110.00 TL
Gökkuşaağı Aynalı 110.00 TL
Gümüş Aynalı 138.00 TL



BX-2500 Solo Ergo Koruyucu Gözlük
Şeffaf Antifog 115.00 TL
Gökkuşaağı Aynalı 145.00 TL
Gümüş Aynalı 170.00 TL



BX-2500 Solo Dual Koruyucu Gözlük
Şeffaf Antifog 181.00 TL
Gökkuşaağı Aynalı 181.00 TL
Gümüş Aynalı 207.00 TL



BX-2500 Comfort Koruyucu Gözlük
Şeffaf Antifog 178.00 TL
Gökkuşaağı Aynalı 178.00 TL
Gümüş Aynalı 204.00 TL



BX-2500 Comfort Ergo Koruyucu Gözlük
Şeffaf Antifog 210.00 TL
Gökkuşaağı Aynalı 210.00 TL
Gümüş Aynalı 237.00 TL



BX-2500 Comfort Dual Koruyucu Gözlük
Şeffaf Antifog 249.00 TL
Gökkuşaağı Aynalı 249.00 TL
Gümüş Aynalı 273.00 TL



BX-2550 Armor Koruyucu Gözlük
Şeffaf Antifog 235.00 TL
Gökkuşaağı Aynalı 235.00 TL
Gümüş Aynalı 261.00 TL
Yedek Lens 92.00 TL



S-503 Usta Gözlüğü
Şeffaf Normal 28.00 TL
Füme 28.00 TL
Siyah 28.00 TL
Sarı 28.00 TL



S-800 Hunter Comfort Koruyucu Gözlük
Şeffaf 30.00 TL
Sarı 30.00 TL
Şeffaf Antifog 50.00 TL
Sarı Antifog 50.00 TL
Gökkuşaağı Aynalı 50.00 TL
Aynalı Gümüş Antifog 67.00 TL



S-1100 Quattro Koruyucu Gözlük
Şeffaf Normal 23.00 TL
Füme 23.00 TL
Sarı 23.00 TL
Mavi 23.00 TL
Şeffaf Antifog 43.00 TL
Gümüş Aynalı Antifog 58.00 TL

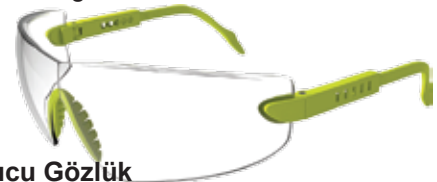

S-300 Koruyucu Gözlük
Şeffaf 23.00 TL
Füme 23.00 TL
Siyah 23.00 TL
Sarı 23.00 TL
Mavi 23.00 TL
Kırmızı 23.00 TL
Yeşil 23.00 TL



S-501 İntegral Koruyucu Gözlük
Mavi 88.00 TL

S-502 İntegral Koruyucu Gözlük
Siyah 88.00 TL



MaxiWeld BX-3200
Otomatik Kararan Kaynak Gözlüğü 13.00 \$
Fermuarlı koruma çantası, ayarlanabilir kafa lastik bandı, ekran koruyucu film ile birlikte settir.



Max-Weld BX-5010 Solo Pro Ayarlı
Parlak mod seviyedi DIN4, Karanlık mod seviyesi DIN9-13
Colormatik Maske 19.00 \$
Colormatik Lens 13.80 \$
Şeffaf Dış Koruma 20.00 TL



Max-Weld BX-5010 Dual Digi Pro Ayarlı
Parlak mod seviyedi DIN4, Karanlık mod seviyesi DIN9-13
Colormatik Maske 120.00 \$
Colormatik Lens 53.00 \$
Şeffaf Dış Koruma 125.00 TL
Antifog Şeffaf İç Taşlama Lens 240.00 TL



Max-Weld BX-5200 Baş Maske
Geniş Kapak - 8x11 cm 116.00 TL
Dar Kapak - 5x11 cm 116.00 TL



Max-Weld BX-5010 Solo
Parlak mod seviyedi DIN3, Karanlık mod seviyesi DIN11
Colormatik Maske 13.00 \$
Colormatik Lens 7.80 \$
Şeffaf Dış Koruma 20.00 TL

BX-6010 Tabcap Kışlık Helmet
Kırmızı 110.00 TL
Saks Mavi 110.00 TL
Sarı 110.00 TL
Turuncu 110.00 TL
Gri 110.00 TL
Petrol Mavi 110.00 TL
Siyah 110.00 TL
Yeşil 110.00 TL



BX-6010 Tabcap Yazlık Helmet
Kırmızı 110.00 TL
Saks Mavi 110.00 TL
Sarı 110.00 TL
Turuncu 110.00 TL
Gri 110.00 TL
Petrol Mavi 110.00 TL
Siyah 110.00 TL
Yeşil 110.00 TL



Max-Weld BX-5010 Solo Ayarlı
Parlak mod seviyedi DIN3, Karanlık mod seviyesi DIN9-11
Colormatik Maske 15.80 \$
Colormatik Lens 11.00 \$
Şeffaf Dış Koruma 20.00 TL





JUNIOR JN1011 Waterproof Fosforlu Oxford Parka

Yüksek görünürlüklü Oxford parka. Yüksek boyunlu gizli kapuşon, kapuşon kordon lastikli Çift yönlü çıtçıtli fermuar. alt kısımda iki adet düz kapaklı cep iç kısımda portföy cep bir adet telefon cebi iki adet omuzdan iki adet gövdeden her iki koldan reflektörlü bant. Kimlik kart koyma yeri vardır.şerit.

S - Küçük Beden	Sarı	46.80 \$
M - Orta Beden	Sarı	46.80 \$
L - Büyük Beden	Sarı	46.80 \$
XL - Extra Büyük Beden	Sarı	46.80 \$
XXL - Extra Büyük Beden	Sarı	46.80 \$

JUNIOR

JN1011/P Waterproof Polarlı Fosforlu Oxford Parka

Yüksek boyunlu gizli kapuşon, kapuşon kordon lastikli, içi polarlı ve çift yönlü çıtçıtli fermuar. alt kısımda iki adet düz kapaklı cep iç kısımda portföy cep bir adet telefon cebi iki adet omuzdan iki adet gövdeden her iki koldan reflektörlü bant.. Kimlik kart koyma yeri vardır.

S - Küçük Beden	Sarı	63.00 \$
M - Orta Beden	Sarı	63.00 \$
L - Büyük Beden	Sarı	63.00 \$
XL - Extra Büyük Beden	Sarı	63.00 \$
XXL - Extra Büyük Beden	Sarı	63.00 \$

JUNIOR JN1012 Waterproof Fosforlu Oxford Parka

S - Küçük Beden	Turuncu	54.00 \$
M - Orta Beden	Turuncu	54.00 \$
L - Büyük Beden	Turuncu	54.00 \$
XL - Extra Büyük Beden	Turuncu	54.00 \$
XXL - Extra Büyük Beden	Turuncu	54.00 \$

JUNIOR

JN1012/P Waterproof Polarlı Fosforlu Oxford Parka

S - Küçük Beden	Turuncu	63.00 \$
M - Orta Beden	Turuncu	63.00 \$
L - Büyük Beden	Turuncu	63.00 \$
XL - Extra Büyük Beden	Turuncu	63.00 \$
XXL - Extra Büyük Beden	Turuncu	63.00 \$



JUNIOR JN1013 Waterproof Fosforlu Oxford Parka

Yüksek boyunlu gizli kapuşon, kapuşon kordon lastikli Çift yönlü çıtçıtli fermuar. alt kısımda iki adet düz kapaklı cep iç kısımda portföy cep bir adet telefon cebi, iki adet omuzdan iki adet gövdeden her iki koldan reflektörlü bant. Kimlik kart koyma yeri vardır.

S - Küçük Beden	Sarı-Lacivert	50.40 \$
M - Orta Beden	Sarı-Lacivert	50.40 \$
L - Büyük Beden	Sarı-Lacivert	50.40 \$
XL - Extra Büyük Beden	Sarı-Lacivert	50.40 \$
XXL - Extra Büyük Beden	Sarı-Lacivert	50.40 \$

JUNIOR JN1014 Waterproof Fosforlu Oxford Parka

S - Küçük Beden	Turuncu-Lacivert	57.60 \$
M - Orta Beden	Turuncu-Lacivert	57.60 \$
L - Büyük Beden	Turuncu-Lacivert	57.60 \$
XL - Extra Büyük Beden	Turuncu-Lacivert	57.60 \$
XXL - Extra Büyük Beden	Turuncu-Lacivert	57.60 \$



JUNIOR JN1003 5+1 İçi Çıkmalı Oxford Fosforlu Parka

Dışı ceket, yüksek boyunlu gizli kapuşon, kapuşon, kordon lastikli. Çift yönlü çıtçıtli fermuar alt kısımda iki adet düz kapalı cep, iç kısımda portföy cep, bir adet telefon cebi, göğüste bir adet yan fermuarlı cep. iki adet omuz da iki adet gövde de , her iki koldan iki adet reflektör bantlı. İç ceket yaka üstüne fermuarlı , polar astarlı, alt kısımda iki adet yan cep ve kimlik kart koyma yeri vardır.

S - Küçük Beden	Sarı	86.40 \$
M - Orta Beden	Sarı	86.40 \$
L - Büyük Beden	Sarı	86.40 \$
XL - Extra Büyük Beden	Sarı	86.40 \$
XXL - Extra Büyük Beden	Sarı	86.40 \$

JUNIOR JN1004 5+1 İçi Çıkmalı Oxford Fosforlu Parka

S - Küçük Beden	Turuncu	100.80 \$
M - Orta Beden	Turuncu	100.80 \$
L - Büyük Beden	Turuncu	100.80 \$
XL - Extra Büyük Beden	Turuncu	100.80 \$
XXL - Extra Büyük Beden	Turuncu	100.80 \$



JUNIOR JN1061 Sarı Oxford Fosforlu Yelek Çift Taraflı

Her iki tarafta yakalı yüksek gri renkli ayarlanabilir kordon elastik gövde üzerinde yansıtıcı bantlar Cırt bantlı iki düz cep1 göğüs telefon cebi, dikey fermuarlı cep, iç gri astarlı Çift taraflıdır, iç ve dış mekanlarda giyilebilir. kimlik kartı yuvası vardır.

S - Küçük Beden	Sarı	28.80 \$
M - Orta Beden	Sarı	28.80 \$
L - Büyük Beden	Sarı	28.80 \$
XL - Extra Büyük Beden	Sarı	28.80 \$
XXL - Extra Büyük Beden	Sarı	28.80 \$

JUNIOR

JN1062 Turuncu Oxford Fosforlu Yelek Çift Taraflı

S - Küçük Beden	Turuncu	28.80 \$
M - Orta Beden	Turuncu	28.80 \$
L - Büyük Beden	Turuncu	28.80 \$
XL - Extra Büyük Beden	Turuncu	28.80 \$
XXL - Extra Büyük Beden	Turuncu	28.80 \$



JUNIOR JN1113 Sarı Oxford Fosforlu Takım

Ceket-Pantolon Takımıdır. Dikişli, hafif ve lastikli yağmurluk, çift cepli, gizli kapüşonlu, omuz, kol ve göğüste çift reflektörlü, fermuarlı, çitçitli, bağcıklı cepli kapüşonlu ve lastikli kollu ve çift katlı ceket yansıtıcı pantolon.yuvası vardır.

S - Küçük Beden	Sarı	30.60 \$
M - Orta Beden	Sarı	30.60 \$
L - Büyük Beden	Sarı	30.60 \$
XL - Extra Büyük Beden	Sarı	30.60 \$
XXL - Extra Büyük Beden	Sarı	30.60 \$

JUNIOR JN1114 Turuncu Oxford Fosforlu Takım

S - Küçük Beden	Turuncu	30.60 \$
M - Orta Beden	Turuncu	30.60 \$
L - Büyük Beden	Turuncu	30.60 \$
XL - Extra Büyük Beden	Turuncu	30.60 \$
XXL - Extra Büyük Beden	Turuncu	30.60 \$



JUNIOR JN1132 İmpertex Yağmurluk 0.18 mm

Ön kısmında iki adet cep bulunmaktadır. Ön kapama çitçitlidir. Yağmurluk kolunun bilekleri lastiklidir. Yağmurluğun boynunda Gizli kapşonu vardır. Kendi özel çantasında gönderilmektedir.

Sarı
Lacivert
Yeşil

JUNIOR JN1142 İmpertex Takım

Ön kısmında iki adet cep bulunmaktadır. Ön kapama çitçitlidir. Yağmurluk kolunun bilekleri lastiklidir. Yağmurluğun boynunda Gizli kapşonu vardır. Kendi özel çantasında gönderilmektedir.

Sarı
Lacivert
Yeşil

JUNIOR JN1100 Sarı Oxford Fosforlu Yağmurluk

Dikişli, hafif ve lastikli yağmurluk, çift cepli, gizli kapüşonlu, omuz, kol ve göğüste çift reflektörlü, Fermuarlı, çitçitli, kapüşonu büzgü bağı cepli ve elastik kollu yağmurluk.

Sarı 25.20 \$

JUNIOR JN1112 Turuncu Oxford Fosforlu Yağmurluk

Turuncu 25.20 \$



BONDING ECO Parka

S - Küçük Beden	Sarı-Lacivert	37.70 \$
M - Orta Beden	Sarı-Lacivert	37.70 \$
L - Büyük Beden	Sarı-Lacivert	37.70 \$
XL - Extra Büyük Beden	Sarı-Lacivert	37.70 \$
XXL - Extra Büyük Beden	Sarı-Lacivert	37.70 \$



Balıkçı Yağmurluk

545.- TL



JUNIOR JN1101 0,32 mm Astarlı Yağmurluk

Ön kısımda iki adet cep bulunmaktadır. Ön kapatma, çitçit kapatmadır. Yağmurluk kolunun bilekleri lastiklidir. Yağmurluğun boynunda Gizli kapşonu vardır. Kendi özel çantasında gönderilmektedir. Nefes alma özelliği vardır.

Sarı	6.80 \$
Lacivert	6.80 \$
Yeşil	6.80 \$

JUNIOR JN1121 0,32 mm Astarlı Takım

Ön kısımda iki adet cep bulunmaktadır. Ön kapatma, çitçit kapatmadır. Yağmurluk kolunun bilekleri lastiklidir. Yağmurluğun boynunda Gizli kapşonu vardır. Kendi özel çantasında gönderilmektedir. Nefes alma özelliği vardır.

Sarı	10.50 \$
Lacivert	10.50 \$
Yeşil	10.50 \$

Astarlı Kısa Ceket

3.90 \$



JUNIOR Tek Kullanımlık Yağmurluk

0.95 \$



EVA Yağmurluk

MES 8998

3.42 \$

Lüks Yağmurluk

MES 965

8.29 \$



Kasık Çizmesi



Göğüs Çizmesi

Kasık Çizmesi

No:40	28714	555.00 TL
No:41	28715	555.00 TL
No:42	28716	555.00 TL
No:43	28717	555.00 TL
No:44	28718	555.00 TL
No:45	28719	555.00 TL

Tulum Göğüs Çizmesi

No:40	28724	775.00 TL
No:41	28725	775.00 TL
No:42	28726	775.00 TL
No:43	28727	775.00 TL
No:44	28728	775.00 TL
No:45	28729	775.00 TL



Tek kullanımlık Yağmurluk

Kullanat model, düğmeli

Kırmızı	MK5100	0.79 \$
Mavi	MK5101	0.79 \$
Sarı	MK5102	0.79 \$
Yeşil	MK5103	0.79 \$
Şeffaf	MK5104	0.79 \$



Süper Yağmurluk, 850 gr, Astarlı

Sarı	MK5150	7.90 \$
Mavi	MK5151	7.90 \$
Yeşil	MK5152	7.90 \$

Lüks Yağmurluk, 600 gr, Görünmez Astarlı

Cepli Sırttan havalandırma

Sarı	MK5140	7.90 \$
Mavi	MK5141	7.90 \$
Yeşil	MK5142	7.90 \$

Süper EVA Yağmurluk, 150 gr, Düğmeli

Sarı	MK5110	2.05 \$
------	--------	---------

PVC Lüks Yağmurluk, Cepli Sırttan Havalandırma 260 gr

Sarı	MK5120	3.25 \$
Yeşil	MK5121	3.25 \$
Açık Mavi	MK5122	3.25 \$
Siyah	MK5123	3.25 \$



Kumpas cep



Komando cep



16x12 gabardin
%100 pamuk kumaş



İki yan cep



60 cm fermuar



Arka bel lastikli



Tek arka cep



Kollar lastikli



Omuz ve cep üstleri
farklı renk kumaş ve
kapaklı cep üstleri



Paçalarda 4 cm
renkli şerit,
2 cm reflektör şerit



Askılı naylon
ambalajda,
market sunumunda



16x12 gabardin
%100 pamuk kumaş



Göğüste üst fermuarlı
robalı cep



İki yan cep



Tek arka cep



Komando cep



Kumpas cep



Lastikli askı



Bel lastikli



Paçalarda 4 cm
renkli şerit,
2 cm reflektör şerit



Askılı naylon
ambalajda,
market sunumunda



Plastik kilitli toka

Boy Tulum

16x12 gabardin, %100 pamuk, 2 yan cep, 60 cm fermuarlı, göğüste üst fermuarlı, tek arka cep, iki üstü kapaklı cep, bir kumpas cep, bir komando cep, paçalarda 4cm renkli şerit, 2cm reflektör şerit, omuzlar ve cep kapakları farklı renk kumaşlı ve beli ve kolları lastikli, naylon ambalajda

Gabardin

M - Orta Beden	Gri	28463	750.00 TL
L - Büyük Beden	Gri	28464	750.00 TL
XL - Extra Büyük Beden	Gri	28465	750.00 TL
M - Orta Beden	Lacivert	28466	750.00 TL
L - Büyük Beden	Lacivert	28467	750.00 TL
XL - Extra Büyük Beden	Lacivert	28468	750.00 TL

Poligabardin

M - Orta Beden	Lacivert	28262	475.00 TL
L - Büyük Beden	Lacivert	28263	475.00 TL
XL - Extra Büyük Beden	Lacivert	28264	475.00 TL
M - Orta Beden	Gri	28265	475.00 TL
L - Büyük Beden	Gri	28266	475.00 TL
XL - Extra Büyük Beden	Gri	28267	475.00 TL

Belirtilen standart dışındaki renkler için, 7x7 kişilik gabardin, özel renk kumaş, 5 cm özel reflektör ya da reflektörsüz kumaş talepleriniz için satış elemanlarımızdan özel fiyat alabilirsiniz.

Bahçıvan Tulum

16x12 gabardin, %100 pamuk, 2 yan cep, göğüste üst fermuarlı ve robalı tek cep, tek arka cep, bir kumpas cep, bir komando cep, paçalarda 4cm renkli şerit, 2cm reflektör şerit, beli lastikli, lastikli askı, plastik kilitli toka askı, naylon ambalajda

Gabardin

M - Orta Beden	Gri	28469	615.00 TL
L - Büyük Beden	Gri	28470	615.00 TL
XL - Extra Büyük Beden	Gri	28471	615.00 TL
M - Orta Beden	Lacivert	28472	615.00 TL
L - Büyük Beden	Lacivert	28473	615.00 TL
XL - Extra Büyük Beden	Lacivert	28474	615.00 TL

Poligabardin

M - Orta Beden	Lacivert	28256	350.00 TL
L - Büyük Beden	Lacivert	28257	350.00 TL
XL - Extra Büyük Beden	Lacivert	28258	350.00 TL
M - Orta Beden	Gri	28259	350.00 TL
L - Büyük Beden	Gri	28260	350.00 TL
XL - Extra Büyük Beden	Gri	28261	350.00 TL



Alpaka Kumaş



Üst ön cep



Beli kuşaklı



Düğmeli



Naylon ambalajda, market sunumunda

İş Önlüğü Alpaka

Alpaka kumaştan (%75 polyester, %25 viskon, 180-185 gr m²), iki yan cep, bir göğüs ceplidir. Önden düğmeli, arka beli kuşaklı, tek renkli, naylon ambalajda

S - Küçük Beden	Gri	28437	635.00 TL
M - Orta Beden	Gri	28475	635.00 TL
L - Büyük Beden	Gri	28476	635.00 TL
XL - Extra Büyük Beden	Gri	28477	635.00 TL
XXL - Extra Büyük Beden	Gri	28495	635.00 TL
S - Küçük Beden	Lacivert	28436	635.00 TL
M - Orta Beden	Lacivert	28478	635.00 TL
L - Büyük Beden	Lacivert	28479	635.00 TL
XL - Extra Büyük Beden	Lacivert	28480	635.00 TL
XXL - Extra Büyük Beden	Lacivert	28527	635.00 TL
S - Küçük Beden	Beyaz	28406	635.00 TL
M - Orta Beden	Beyaz	28405	635.00 TL
L - Büyük Beden	Beyaz	28404	635.00 TL
XL - Extra Büyük Beden	Beyaz	28403	635.00 TL
XXL - Extra Büyük Beden	Beyaz	28402	635.00 TL

Poligabardin İş Önlüğü

S - Küçük Beden			400.00 TL
M - Orta Beden			400.00 TL
L - Büyük Beden			400.00 TL
XL - Extra Büyük Beden			400.00 TL
XXL - Extra Büyük Beden			400.00 TL



Bayan Pötikare Önlük

S - Küçük Beden	Mavi	28481	550.00 TL
M - Orta Beden	Mavi	28482	550.00 TL
L - Büyük Beden	Mavi	28483	550.00 TL
XL - Extra Büyük Beden	Mavi	28490	550.00 TL
XXL - Extra Büyük Beden	Mavi	28526	550.00 TL
S - Küçük Beden	Pembe	28491	550.00 TL
M - Orta Beden	Pembe	28492	550.00 TL
L - Büyük Beden	Pembe	28493	550.00 TL
XL - Extra Büyük Beden	Pembe	28494	550.00 TL
XXL - Extra Büyük Beden	Pembe	28525	550.00 TL

Belirtilen standart dışındaki renkler için, özel renk kumaş, özel reflektör ve pötikare pantolon talepleriniz için satış elemanlarımızdan özel fiyat alabilirsiniz.



16x12 gabardin %100 pamuk kumaş



Paçalarda 4 cm renkli şerit, 2 cm reflektör şerit



Komando cep



Naylon ambalajda, market sunumunda

Pantolon + Ceket Takım

Ceket; 16x12 gabardin %100 pamuk kumaş, iki yan cep, tek üst cep, omuzlar ve cep üstleri farklı renk kumaş, önden düğmeli.

Pantolon; iki yan cep, bir komando cep, bir kumpas cep, beli lastikli, paçalarda 4cm renkli şerit, 2cm reflektör şerit, naylon ambalajında

Gabardin

M - Orta Beden	Gri	28487	750.00 TL
L - Büyük Beden	Gri	28488	750.00 TL
XL - Extra Büyük Beden	Gri	28489	750.00 TL
M - Orta Beden	Lacivert	28484	750.00 TL
L - Büyük Beden	Lacivert	28485	750.00 TL
XL - Extra Büyük Beden	Lacivert	28486	750.00 TL

Poligabardin

M - Orta Beden	Lacivert	28268	500.00 TL
L - Büyük Beden	Lacivert	28269	500.00 TL
XL - Extra Büyük Beden	Lacivert	28270	500.00 TL
M - Orta Beden	Gri	28271	500.00 TL
L - Büyük Beden	Gri	28272	500.00 TL
XL - Extra Büyük Beden	Gri	28273	500.00 TL



Omuz ve cep üstleri farklı renk kumaş



Tek üst cep



Bel lastikli



Kumpas cep



Düğmeli

Düğmeli



Nylon ambalajda, market sunumunda



Bel lastikli



İki yan cep



Paçalarda 4 cm renkli şerit, 2 cm reflektör şerit



Komando cep



Tek arka cep



16x12 gabardin %100 pamuk kumaş



Komando cep



Yıkamalı Kot kumaş



Tek arka cep



İki yan cep



Kumpas cep



Bel lastikli

Kot İş Pantalonu İnce

Yıkamalı kumaş, 7-5 ons, poterezli, kot ipi kullanılmıştır. Beli lastikli, komando cepli, kumpas cep, üstten vurma 2 adet cep, arkada tek ceplidir.

44 Beden	28292	575.00 TL
46 Beden	28293	575.00 TL
48 Beden	28294	575.00 TL
50 Beden	28295	575.00 TL
52 Beden	28296	575.00 TL
54 Beden	28297	575.00 TL
56 Beden	28298	575.00 TL

Kot İş Pantalonu Kalın

Yıkamalı kumaş, 10-5 ons, poterezli, kot ipi kullanılmıştır. Beli lastikli, komando cepli, kumpas cep, üstten vurma 2 adet cep, arkada tek ceplidir. Kaynakçılar ve ağır metal sanayi allanlarında kullanılır.

44 Beden	29020	625.00 TL
46 Beden	29021	625.00 TL
48 Beden	29022	625.00 TL
50 Beden	29023	625.00 TL
52 Beden	29024	625.00 TL
54 Beden	29025	625.00 TL
56 Beden	29026	625.00 TL



Kargo Cepli Pantolon

16x12 gabardin kumaş, kargo cepli, toplamda 4 adet cepli, arkası lastiklidir.

44 Beden	715.00 TL
46 Beden	715.00 TL
48 Beden	715.00 TL
50 Beden	715.00 TL
52 Beden	715.00 TL
54 Beden	715.00 TL
56 Beden	715.00 TL

İş Pantalonu (Mevsimlik)

16x12 gabardin, %100 pamuk, 2 yan cep, bir komando cep, beli lastikli, tek arka cep, paçalarda 4cm renkli şerit, 2cm reflektör şerit, naylon ambalajda

Gabardin

44 Beden, Gri / Lacivert	28444 / 28060	396.00 TL
46 Beden, Gri / Lacivert	28445 / 28061	396.00 TL
48 Beden, Gri / Lacivert	28446 / 28062	396.00 TL
50 Beden, Gri / Lacivert	28447 / 28063	396.00 TL
52 Beden, Gri / Lacivert	28448 / 28064	396.00 TL
54 Beden, Gri / Lacivert	28449 / 28065	396.00 TL
56 Beden, Gri / Lacivert	28450 / 28066	396.00 TL

Poligabardin

44 Beden, Gri / Lacivert	28067 / 28274	365.00 TL
46 Beden, Gri / Lacivert	28068 / 28275	365.00 TL
48 Beden, Gri / Lacivert	28069 / 28276	365.00 TL
50 Beden, Gri / Lacivert	28070 / 28277	365.00 TL
52 Beden, Gri / Lacivert	28071 / 28278	365.00 TL
54 Beden, Gri / Lacivert	28072 / 28279	365.00 TL
56 Beden, Gri / Lacivert	28073 / 28286	365.00 TL

İş Pantalonu (Kışlık)

7x7 gabardin, %100 pamuk, 2 yan cep, bir komando cep, bir kumpas cep, beli lastikli, tek arka cep, naylon ambalajda

Gabardin

44 Beden, Gri / Lacivert	28074 / 28081	485.00 TL
46 Beden, Gri / Lacivert	28075 / 28082	485.00 TL
48 Beden, Gri / Lacivert	28076 / 28083	485.00 TL
50 Beden, Gri / Lacivert	28077 / 28084	485.00 TL
52 Beden, Gri / Lacivert	28078 / 28085	485.00 TL
54 Beden, Gri / Lacivert	28079 / 28086	485.00 TL
56 Beden, Gri / Lacivert	28080 / 28087	485.00 TL



Fermuar patlı

Alt kısım kemerli
Kol ağzı ribanalı

Reflektör şerit



İç cep ve kapitoneli



İki adet kapaklı cep



İki üstten vurma cep

Reflektörlü Kapitoneli İş Montu

7-7 kumaştan, içi kapitoneli, 2.5 cm reflektörlü, 2 adet ön üstten vurmali cepli, ütte 2 adet kapaklı cepli, fermuar patlı, kemerli il montu, standart lacivert renklidir.

S - Küçük Beden	28233	950.00 TL
M - Orta Beden	28226	950.00 TL
L - Büyük Beden	28227	950.00 TL
XL - Extra Büyük Beden	28228	950.00 TL
XXL - Extra Büyük Beden	28234	950.00 TL



İç cep ve kapitoneli



İki adet kapaklı cep



İki üstten vurma cep

Reflektörlü Kapitoneli Yelek

7-7 kumaştan, içi kapitoneli, 2.5 cm reflektörlü, 2 adet ön üstten vurmali cepli, ütte 2 adet kapaklı cepli, 1 adet iç cep, fermuar patlı, standart lacivert renklidir.

S - Küçük Beden	29096	480.00 TL
M - Orta Beden	29097	480.00 TL
L - Büyük Beden	29098	480.00 TL
XL - Extra Büyük Beden	29099	480.00 TL
XXL - Extra Büyük Beden	29100	480.00 TL



Polo Yaka Sweat Uzun Kol

2 ip shirt, şardonlu kumaş, polo yakalı, yakası 2 düğmelidir. Göğüs üstü tek cepli, kol ağzı ribanalı, etek kısmı düzdür. i biye dikişlidir.

M - Orta Beden	29066	360.00 TL
L - Büyük Beden	29067	360.00 TL
XL - Extra Büyük Beden	29068	360.00 TL

Polo Yaka Tişört Kısa Kol

Opened kumaş, polo yakalı, yakası iki düğmeli, göğüs cepli, yaka içi biye dikişlidir.

S - Küçük Beden	28402	275.00 TL
M - Orta Beden	28504	275.00 TL
L - Büyük Beden	28503	275.00 TL
XL - Extra Büyük Beden	28502	275.00 TL
XXL - Extra Büyük Beden	28495	275.00 TL



Polar Fermuarlı Üst

S - Küçük Beden	455.00 TL
M - Orta Beden	455.00 TL
L - Büyük Beden	455.00 TL
XL - Extra Büyük Beden	455.00 TL
XXL - Extra Büyük Beden	455.00 TL



Polar iç astar



Üstte kemik fermuarlı cep



İki adet kemik fermuarlı cep

Polarlı Yelek

Polar iç astarlı, 150 gr silikon elyaf, su itici özellikli kumaş, çift iğne dikişli, altta 2 adet kemik fermuarlı cep, üstte 1 adet kemik fermuarlı cep, içte astar ceplidir. Siyah, lacivert, kırmızı standart renklidir.

S - Küçük Beden	28245	700.00 TL
M - Orta Beden	28252	700.00 TL
L - Büyük Beden	28253	700.00 TL
XL - Extra Büyük Beden	28254	700.00 TL
XXL - Extra Büyük Beden	28255	700.00 TL



Reflektörlü Kaban Tek Parça

İmperteks 190 gr/m² refelktifli kumaş, 190 gr kapitoneli ve su geçirmez kumaş, körüklü cepli, sökülebilir kapşon, manşetlerde gizli lastik, belde bizme ipi, dikişler su geçirmez bantlı, 5 cm reflektif şerit.

M - Orta Beden	Sarı	28415	34.20 \$
L - Büyük Beden	Sarı	28416	34.20 \$
XL - Extra Büyük Beden	Sarı	28417	34.20 \$
M - Orta Beden	Turuncu	28418	34.20 \$
L - Büyük Beden	Turuncu	28419	34.20 \$
XL - Extra Büyük Beden	Turuncu	28420	34.20 \$
M - Orta Beden	Lacivert	28421	34.20 \$
L - Büyük Beden	Lacivert	28422	34.20 \$
XL - Extra Büyük Beden	Lacivert	28423	34.20 \$

Reflektörlü Yelek

İmperteks 190 gr/m² refelktifli kumaş, 190 gr kapitoneli ve su geçirmez kumaş, körüklü cepli, dikişler su geçirmez bantlı, 5 cm reflektif şerit.

M - Orta Beden	Sarı	28424	28.80 \$
L - Büyük Beden	Sarı	28425	28.80 \$
XL - Extra Büyük Beden	Sarı	28426	28.80 \$
M - Orta Beden	Turuncu	28427	28.80 \$
L - Büyük Beden	Turuncu	28428	28.80 \$
XL - Extra Büyük Beden	Turuncu	28429	28.80 \$



5 cm İki Şerit Reflektörlü Yelek

110 gr

Sarı	28432	52.00 TL
Turuncu	28434	52.00 TL

Mühendis Tip Fosforlu Yelek	28431	140.00 TL
-----------------------------	-------	-----------



Göz Duşu Duvar Seti CPS023

51.00 €



Göz Solüsyonu
250 ml - ACQ425
500 ml - ACQ426

8.21 €
24.84 €



Deri Kaynakçı Baş Maske 28392 375.00 TL
Deri Kaynakçı Baş Maske Küçük 165.00 TL
Kumaş Başa Geçme Maske



Deri Kaynakçı Kolluğu 28722 260.00 TL
Deri Kaynakçı Önlük 28390 260.00 TL
Deri Kaynakçı Tozluk 28391 260.00 TL



Kumaş Kaynakçı Kolluk 28720 125.00 TL



SL-03 Aramid Kolluk 10.75 \$
35 cm, Yanmaz ve kesilme direnci yüksek



Bulaşıkçı Önlüğü (70x100 cm)
Beyaz 28385 90.00 TL
Lacivert 28386 90.00 TL

Bulaşıkçı Önlüğü (70x120 cm)
Beyaz 28385 120.00 TL
Lacivert 28386 120.00 TL



Tek Kullanımlık Tulum 70.00 TL



V Yaka Penye Tişört

Kırmızı, Füme, Turkuaz, Gri

S	T28VY94	225.00 TL
M		225.00 TL
L		225.00 TL
XL		225.00 TL
XXL		225.00 TL
XXXL		225.00 TL



Lacoste Biyeli Fermuarlı Tişört

Saks mavi, turkuaz, füme, gri

S	T45LB91	335.00 TL
M		335.00 TL
L		335.00 TL
XL		335.00 TL
XXL		335.00 TL
XXXL		335.00 TL



Polo Yaka 2 iplik Uzun Kol Sweat

S	SV52PY85	440.00 TL
M		440.00 TL
L		440.00 TL
XL		440.00 TL
XXL		440.00 TL
XXXL		440.00 TL



Sıfır Yaka Penye Tişört Biyeli

Kırmızı, Füme, Turkuaz, Gri

S	T30B48	225.00 TL
M		225.00 TL
L		225.00 TL
XL		225.00 TL
XXL		225.00 TL
XXXL		225.00 TL



Sıfır Yaka Penye Uzun Kol Tişört, İnterlock

Mavi

S	T35U11	313.00 TL
M		313.00 TL
L		313.00 TL
XL		313.00 TL
XXL		313.00 TL
XXXL		313.00 TL



Sıfır Yaka 2 iplik Uzun Kol Sweat

S	SV50B54	420.00 TL
M		420.00 TL
L		420.00 TL
XL		420.00 TL
XXL		420.00 TL
XXXL		420.00 TL



Polo Yaka Penye Tişört

Kırmızı, Füme, Turkuaz, Lacivert

S	T40YB51L	295.00 TL
M		295.00 TL
L		295.00 TL
XL		295.00 TL
XXL		295.00 TL
XXXL		295.00 TL



Sıfır Yaka Penye Tişört Uzun Kol

Gri

S	T34U34	275.00 TL
M		275.00 TL
L		275.00 TL
XL		275.00 TL
XXL		275.00 TL
XXXL		275.00 TL



Sıfır Yaka 2 iplik Uzun Kol Robalı Sweat

Füme, Gri, Kırmızı

S	SV56RB91	503.00 TL
M		503.00 TL
L		503.00 TL
XL		503.00 TL
XXL		503.00 TL
XXXL		503.00 TL



Polo Yaka 2 iplik Sweat Fermuarlı
Lacivert, Füme, Gri, Kırmızı

S	SV60FR19	525.00 TL
M		525.00 TL
L		525.00 TL
XL		525.00 TL
XXL		525.00 TL
XXXL		525.00 TL



Kapşonlu Cepli Sweat

Lacivert, Gri, Füme, Kırmızı

S	SV67KP52	592.00 TL
M		592.00 TL
L		592.00 TL
XL		592.00 TL
XXL		592.00 TL
XXXL		592.00 TL



Gabardin Kapitoneli Yelek 7/7

S	Y82GB95	1050.00 TL
M		1050.00 TL
L		1050.00 TL
XL		1050.00 TL
XXL		1050.00 TL
XXXL		1050.00 TL



Polar Sweat

Lacivert

S	SV67P52	408.00 TL
M		408.00 TL
L		408.00 TL
XL		408.00 TL
XXL		408.00 TL
XXXL		408.00 TL



Gabardin Yazlık Yelek 16/12

Lacivert, Gri,

S	Y99YZ54	728.00 TL
M		728.00 TL
L		728.00 TL
XL		728.00 TL
XXL		728.00 TL
XXXL		728.00 TL



Softjel Mont Kolu Çıkmal

Gri, Kırmızı

S	M227SJ62	1590.00 TL
M		1590.00 TL
L		1590.00 TL
XL		1590.00 TL
XXL		1590.00 TL
XXXL		1590.00 TL



Kolu Çıkmalı Kaban

Turuncu, Kırmızı Sarı, Lacivert, Gri,

S	K214C12	1548.00 TL
M		1548.00 TL
L		1548.00 TL
XL		1548.00 TL
XXL		1548.00 TL
XXXL		1548.00 TL



Micro Yelek

Mavi, Gri, Kırmızı

S	Y95MC68	687.00 TL
M		687.00 TL
L		687.00 TL
XL		687.00 TL
XXL		687.00 TL
XXXL		687.00 TL



Reflektörlü Uzun Kaban

Turuncu/Lacivert, Sarı/Lacivert,
Lacivert

S	K206R40	1568.00 TL
M		1568.00 TL
L		1568.00 TL
XL		1568.00 TL
XXL		1568.00 TL
XXXL		1568.00 TL



Polar Kolu Çıkmalı Mont

S		830.00TL
M	MC101P85	830.00 TL
L		830.00 TL
XL		830.00 TL
XXL		830.00 TL
XXXL		830.00 TL



İş Önlüğü

S	NL67K13	564.00 TL
M		564.00 TL
L		564.00 TL
XL		564.00 TL
XXL		564.00 TL
XXXL		564.00 TL



Gabardin Kışlık Pantolon 7/7

S	P63KS27	748.00 TL
M		748.00 TL
L		748.00 TL
XL		748.00 TL
XXL		748.00 TL
XXXL		748.00 TL



Gabardin İçi Kapitoneli Mont 7/7

S	M119G60	1385.00 TL
M		1385.00 TL
L		1385.00 TL
XL		1385.00 TL
XXL		1385.00 TL
XXXL		1385.00 TL



Gabardin Yazlık Pantolon Biyeli 16/12

Lacivert, Gri		
S	M100Y64	687.00 TL
M		687.00 TL
L		687.00 TL
XL		687.00 TL
XXL		687.00 TL
XXXL		687.00 TL



Gabardin Pantolon 16/12

Lacivert		
S	P57YZ10	572.00 TL
M		572.00 TL
L		572.00 TL
XL		572.00 TL
XXL		572.00 TL
XXXL		572.00 TL



Gabardin Yazlık Mont 16/12

Lacivert, Gri		
S	M100Y64	995.00 TL
M		995.00 TL
L		995.00 TL
XL		995.00 TL
XXL		995.00 TL
XXXL		995.00 TL



Gabardin Pantolon Fermuarlı 16/12

S	P72YZ06	675.00 TL
M		675.00 TL
L		675.00 TL
XL		675.00 TL
XXL		675.00 TL
XXXL		675.00 TL



Profesyonel Çelik Burun İş Ayakkabısı

Yarma deri, nefes alabilen terletmeyen astar, 200 joule-1500 N baskı mukavemetli çelik bombe, poliüretan, antistatik, yağ ve petrole dayanıklı tabanlı, antistatik taban astarlı, metal kuşgözü kapsül bağlamalı, saya üzerine direk enjeksiyon ile imal edilmiştir. EN ISO 20345 S1, SP1, S2, S3 Sstandartlarında

No: 36		645.00 TL
No: 37		645.00 TL
No: 38		645.00 TL
No: 39	28359	645.00 TL
No: 40	28360	645.00 TL
No: 41	28361	645.00 TL
No: 42	28362	645.00 TL
No: 43	28363	645.00 TL
No: 44	28364	645.00 TL
No: 45	28365	645.00 TL
No: 46		645.00 TL



Profesyonel Çelik Burun İş Botu

No: 39	28369	790.00 TL
No: 40	28370	790.00 TL
No: 41	28371	790.00 TL
No: 42	28372	790.00 TL
No: 43	28373	790.00 TL
No: 44	28374	790.00 TL
No: 45	28375	790.00 TL



MEKAP JÜPİTER 101-S1 Baskılı Deri İş Ayakkabısı

No: 36	36.50 €
No: 37	36.50 €
No: 38	36.50 €
No: 39	36.50 €
No: 40	36.50 €
No: 41	36.50 €
No: 42	36.50 €
No: 43	36.50 €
No: 44	36.50 €
No: 45	36.50 €



MEKAP JÜPİTER 157-S1 Süet Cırtlı İş Ayakkabısı

No: 36	36.00 €
No: 37	36.00 €
No: 38	36.00 €
No: 39	36.00 €
No: 40	36.00 €
No: 41	36.00 €
No: 42	36.00 €
No: 43	36.00 €
No: 44	36.00 €
No: 45	36.00 €



Yazlık Cırtlı Çelik Burun Süet İş Ayakkabı

Süet deri, nefes alabilen terletmeyen astar, 200 joule 1500 N baskı mukavemetli çelik bombe, poliüretan, - antistatik, yağ ve petrole dayanıklı tabanlı, antistatik taban astarlı, cırtlı, saya üzerine direk enjeksiyon ile imal edilmiştir. EN ISO 20345, S1, S1P standartları vardır.

No: 36		655.00 TL
No: 37		655.00 TL
No: 38		655.00 TL
No: 39		655.00 TL
No: 40	28308	655.00 TL
No: 41	28309	655.00 TL
No: 42	28310	655.00 TL
No: 43	28311	655.00 TL
No: 44	28312	655.00 TL
No: 45	28313	655.00 TL
No: 46		655.00 TL



Kaynakçı Çelik Burun İş Ayakkabısı

No : 39	28314	750.00 TL
No: 40	28315	750.00 TL
No: 41	28316	750.00 TL
No: 42	28317	750.00 TL
No: 43	28318	750.00 TL
No: 44	28319	750.00 TL
No: 45	28320	750.00 TL



Esnek Şerit Ayırıcı

Yüksek esneklikte TPU malzemeden yapılmıştır. Esnek, kırılmaz ve bükülebilir gövde. Hava şartlarına dayanıklıdır. Delinatör sarı, turuncu ve diğer renklerde UV katkılıdır. Reflektif halkalar gümüş ve beyaz renkte, gece-gündüz yüksek görünür özellikte mikroprizmatik reflektif malzeme ve PVC filminden yapılmıştır. Darbeye dayanıklı ve yüksek performanslıdır. Esnek delinatörlerin kullanım amacı; ışığı yansıtan reflektörlü şeritler sayesinde, iş alanlarında, trafik kontrollerinde, şerit ayrımında, yol çalışmalarında ve tehlike arz eden bölgelerde sürücü ve yaya güvenliğini sağlamak için kullanılır. Gövdenin tabandan itibaren 1/3'lük kısmı körüklüdür. 3 adet zemine bağlantı noktası vardır. 9 mm triton vida ve 16 mm plastik dübel ile uygulanır. Montaj ve dübel seti ürüne dahildir.

45 cm	UT2502	6.30 \$
75 cm	UT2503	7.10 \$
100 cm	UT2519	12.50 \$

Extra Montaj Vidası (Adet satılır)		0.27 \$
Extra Montaj Dübeli (Adet satılır)		0.14 \$



Dubalı Uyarı Dikmesi (Mıçır Tabanlı)

60x1200 mm	UT6003	12.50 \$
110x1200 mm	UT2141	17.10 \$



Trafik Konisi	UT5024	6.20 \$
PE malzeme, ağırlıksız, 50 cm yükseklik 285x285 mm taban, 0.56 kg		



Ağırlıklı Taban Trafik Konisi	UT5021	15.50 \$
PVC malzeme, 50 cm yükseklik 350x500x50 mm taban, 4 kg		



Dikdörtgen Uyarı Levhası	UT4050	3.60 \$
380x430 mm panel ebatı, 0.64 kg		



Kulplu Yumuşak ReflektifliTrafik Konisi

75 cm	UT5011	15.- \$
385x750 mm, 5.65 kg		

Kulplu Yumuşak ReflektifliTrafik Konisi

90 cm	UT5008	20.- \$
385x900 mm, 6 kg		
PVC malzemeden, taban çapı 385 mm, 4 kenarlıdır.		



Plastik Kaygan Zemin Uyarı Levhası

ABS malzemeden,	UT4001	6.50 \$
630x215x340 mm, 1.21 kg		

Plastik Kaygan Zemin Uyarı Levhası

(Baskısız)ABS malzemeden,	UT4000	6.10 \$
630x215x340 mm, 1.21 kg		



Kalın Uyarı Dikmesi Alt Taban

9.7 kg	UT3106	7.38 \$
--------	--------	---------

İnce Uyarı Dikmesi Alt Taban

4 kg	UT3108	6.50 \$
------	--------	---------

Trafik Konisi Ağırlık Tabanı

2 kg	UT3116	7.15 \$
------	--------	---------



Trafik Koni Kancası

Delinatörlere zincir takılması için kullanılır.	UT3102	0.65 \$
---	--------	---------



Trafik Konisi Adaptörü

Delinatörlere zincir takılması için kullanılır.	UT3112	1.35 \$
---	--------	---------



Delinatör Bağlantı Adaptörü

80 mm çap, delinatörlere bağlantı için kullanılır.	UT3103	0.85 \$
--	--------	---------



Yolda Çalışma Var Levhası
Çift taraflıdır, UT2807
330x430 mm, 5 mm kalınlık

7.95 \$



Park Yasak Levhası
Çift taraflıdır, UT2901
390 mm yükseklik, 5 mm kalınlık

7.95 \$



Sola Mecburi Yön Levhası
Çift taraflıdır, UT2902
390 mm yükseklik, 5 mm kalınlık

7.95 \$

Sağa Mecburi Yön Levhası
Çift taraflıdır, UT2903
390 mm yükseklik, 5 mm kalınlık

7.95 \$



Girişi Olmayan Yol Levhası
Çift taraflıdır, UT2904
390 mm yükseklik, 5 mm kalınlık

9.95 \$



Güneş Enerjili Flaşör Sarı
Güneş enerjilidir, UT2101
95x240x280 mm

22.- \$

Güneş Enerjili Flaşör Kırmızı
Güneş enerjilidir, UT2102
95x240x280 mm

22.- \$



CM 600 Trafik Güvenlik Aynası

85.- \$

600 mm çap,
2 mm akrilik aynada, turuncu şapkalı olarak imal edilmiştir.

CM 800 Trafik Güvenlik Aynası

113.- \$

800 mm çap,
2 mm akrilik aynada, turuncu şapkalı olarak imal edilmiştir.

CM 1000 Trafik Güvenlik Aynası

333.- \$

1000 mm çap,
2 mm akrilik aynada, turuncu şapkalı olarak imal edilmiştir.

CM 1200 Trafik Güvenlik Aynası

812.- \$

1200 mm çap,
2 mm akrilik aynada, turuncu şapkalı olarak imal edilmiştir.



Pastik Sarı Hız Kesici Kasis UT9020
Sarı renkli, 350x250x50 mm, 1.32 kg

12.35 \$

Pastik Sarı Hız Kesici Kasis UT9022
Siyah renkli, 350x250x50 mm, 1.32 kg

12.35 \$

350x250x50 mm ebatlarında, 1.32 kg, PPC malzemeden, -20 +60 C hava şartlarına dayanıklıdır. Mukavemeti yüksek hammadde, gece yüksek görünür özellikli reflektör, dayanıklı ve yüksek performans, 9 mm vida ve 16 mm dübel ile yola sabitleme yapılarak montajı olur. ISO 9001:2008 - CE



Hız Kesici Kasis Başık UT9021
Sarı renkli, 200x10x5 mm, 0.34 kg

4.10 \$

Hız Kesici Kasis Başık UT9023
Siyah renkli, 200x10x5 mm, 0.34 kg

4.10 \$



Otopark Köşe Koruyucu UT7005
PVC malzemeden, reflektifli oval tip, 90x80x780 mm, 1.9 kg

6.90 \$

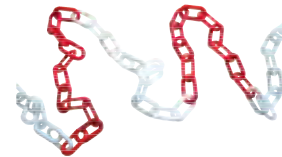

Plastik Zincir UT3120

0.85 \$/Metre

Kırmızı beyaz renkli, 6 mm çap, PP malzemeden, 200 metrelik ambalajlıdır.



CT-9166

CT-9167

CT-9170

CT-9174



CT-9175

CT-9176

CT-9178

CT-9179

Ledli Exit Armatürler

220.- TL



FL-1101

FL-1201

FL-1301

FL-1401



FL-1501

FL-1601

FL-1701

FL-1801



FL-3101

FL-3201

FL-3301

FL-3401



FL-3501

FL-3601

FL-3701

FL-3801



FL-5101

FL-5201

FL-5301

FL-5401



FL-5501

FL-5601

FL-5701

FL-5801

Fotolümenli Acil Yön Levaları (Dekota malzeme 3 mm)

8x19.5 cm	28748	1.35 \$
12x29.5 cm	28749	3.10 \$
18x44.5 cm	28750	6.95 \$



İş İkaz Levhaları

25x35 cm Plastik	28741	1.90 \$
35x50 cm Plastik	28742	3.80 \$
25x35 cm Metal	28745	6.50 \$
35x50 cm Metal	28746	13.00 \$
25x35 cm Dekota 5 mm	28751	3.65 \$
35x50 cm Dekota 5 mm	28752	7.35 \$



12'li İnşaat Uyarı Seti (Dekota 3 mm)

32.00 \$

10'lu İnşaat yarı Seti (PVC)

14.25 \$

Büyük İnşaat Uyarı Panosu
Dekota 3 mm

21.30 \$



Yangın Söndürücüler

Tozlu 1 Kg	570.- TL
Tozlu 2 Kg	760.- TL
Tozlu 4 Kg	1 315.- TL
Tozlu 6 Kg	1 405.- TL
Tozlu 12 Kg	2 470.- TL
50 Kg tekerlekli	10 450.- TL
Askı Aparatı	37.00 TL



İlk Yardım Seti

31.75 \$

Flaster, yara bandı, yapışmalı yara pedi, koruma örtüsü, sarğı bezi, üçgen sarğı bezi, elastik bandaj, steril gazlı bez, hidrofıl pamuk, anında soğutma kompres, tekstil turnike, suni solunum maskesi, antiseptik solüsyon, oksijenli su, dijital termometre, cımbız, çengelli iğne, tek kullanımlık eldiven, makas, ilk yardım kitapçığı



Ekonomik İlk Yardım Seti

2.90 \$

1 Eldiven, 1 turnike lastik, 5 yarabandı, 1 fener, 1 solüsyon, 1 bandaj, 1 yanık örtüsü, 1 makas, 1 gaz kompres, 1 üçgen bezi, 1 boyunluk, 2 gazlı bez



Yangın Battanisi

130x180 cm

10.50 \$

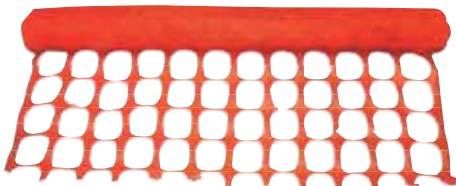

Emniyet Filesi Alan Perdesi 110 gr/m2

1x50 mt - 1 top/50 mt 435.- TL/top



Emniyet Kemerı, Paraşüt Tipi

E 121 28543
Karabına ve halat fiyata dahildir.

18.50 \$



Emniyet Kemerı, Bel Tipi

Bel takviyeli

19.60 \$

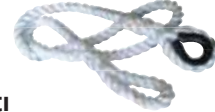

Emniyet Kemerı Halatı

120 cm

4.10 \$



Karabına Vidalı

22 mm

3.40 \$

Kanca Karabına

53 mm ağız açıklığı

6.00 \$



JN6104

Çift Bacak Şok Emici Lanyard (Sertifikalı)

12 mm polyester ip, 51 mm kanca kapı açıklığı

27.00 \$



HARU Düşüş Tutucu Çelik Halat

HE-06 D:4.8 mm x 6 m	300.00 \$
HE-10 D:4.8 mm x 10 m	310.00 \$
HE-15 D:4.8 mm x 15 m	480.00 \$
HE-20 D:4.8 mm x 20 m	557.00 \$
HE-25 D:4.8 mm x 25 m	900.00 \$
HE-30 D:4.8 mm x 30 m	965.00 \$



2306 Kulak Tıkacı 0.13 \$
200 adet/pk
2306 C İpli Kulak Tıkacı 0.20 \$
100 adet/pk
2306 Dökme İpli Kulak Tıkacı 44.00 \$
500 çift/pk



1707 T İpli Kulak Tıkacı 0.33 \$
100 adet/pk



2706 C İpli Kulak Tıkacı 0.35 \$
100 adet/pk



Kulak Tıkacı Dispanseri 65.- \$
Dolu (2306 - 1000 adet)
Boş 24.- \$



Gürültü Önleyici Kulaklık 3.80 \$
Gürültü azalma seviyesi 19dB,
yüksekliği ayarlanabilir baş bandı
28661



Barete Takılabilir ulaklık 12.00 \$
25.9 dB gürültü azaltma seviyesi



JUNIOR Vizor Set



JUNIOR Vizor Cam 2.19 \$
JUNIOR Braket Yaylı 6.50 \$



YS 51 3.00 \$
Barete Takılan Yüz Siperi



Baret, Arkadan Vidalı
CE, EN 397, vida ile sıkıştırma,
6 noktadan bağlantı, ter bantlı,
52-62 cm, -10C +50C
Sarı 28649 2.70 \$
Kırmızı 28650 2.70 \$
Beyaz 28651 2.70 \$
Mavi 28652 2.70 \$



Baret, Arkadan Klipsli
CE, EN 397, slayt sistem ile
kiitleme, 6 noktadan bağlantı,
ter bantlı, 52-62 cm, -10C
+50C
Sarı 28645 2.40 \$
Kırmızı 28646 2.40 \$
Beyaz 28647 2.40 \$
Mavi 28648 2.40 \$

Baret, Renk Srandartları
Beyaz - Üst süzey yönetici ve ziyaretçiler
Mavi - Mühendis be teknik elemanlar
Turuncu - Formenler ve usta başları
Sarı - İşçiler
Yeşil - Sağlık Personeli



Madenci Baret Vidalı 5.90 \$



Toz Maskesi, Kubbeli Tip, Ventil
FFP3 11.50 TL
FFP3 Aktif Karbon 16.10 TL
Weti FFP3 16.10 TL



Toz Maskesi, Ventil Katlanır Tip
FFP2 8.00 TL
FFP3 8.00 TL
FFP2 Katlanır Ventilersiz 7.00 TL



Tek Kullanımlık Maske 95.00 TL
50 adet/pk 28509



Maske Tutma Aparatı 2.00 TL
Maske Burun Aparatı 25.00 TL



ERA 1110 FFP1 V NR 13.35 TL
Ventil Katlanır Toz Maskesi

ERA 1210 FFP2 V NR 15.40 TL
Ventil Katlanır Toz Maskesi



ERA 6210 FFP2 V NR D 21.35 TL
Ventil Toz Maskesi

ERA 5210 AC FFP2 V NR D 25.15 TL
Ventil Aktif Karbon Katlanır Toz Maskesi



ERA 7210 AC FFP2 V NR D 41.00 TL
Ventil Aktif Karbon Toz Maskesi

ERA 9920 AC FFP2 V NR D 34.00 TL
Ventil Aktif Karbon Toz Maskesi



SMA 16 Darbeli Matkap 91.50 \$
1050 watt, 13 mm, 0-1000 / 0-2800 hız ayarlı
R+L sağ-sol dönüş, 3.3 kg
Koli Adedi: 5



DM 13 CE Darbesiz Matkap 75.40 \$
710 watt, 13 mm, pratik mandren,
hız ayarlı, R+L sağ-sol dönüş, 2.1 kg
Koli Adedi: 5



LİTO 36 Lityum Akülü Tornavida 24.- \$
Lityum pil, 3.6 Volt, 1.3 Ah, 200 min-1, 160 dk.
şarj süresi 2.75 Nm tork, lityum pil, 350 gr,
bez çantada



DT 18 Kalıpcı Taşlama 44.90 \$
Metal Kafa Kısa Tip, 650 watt,
11500 -32000 d/dk, 2 mt kablo. 1.5 ka
Koli Adedi: 10



Taşlama Kesim Aparatı
230 mm jet taşlamalar için 51410 49.40 \$
Koli Adedi: 6
115 mm Avuç taşlamalar için 51411 34.80 \$
Koli Adedi: 10



Matkap Sehпасı 51210 29.50 \$
Koli Adedi : 4



8016 Havalı Zimba Tabancası 09651 45.60 \$
12.8x4-14 mm zimba teli, 4-7 bar, 120 adet
zimba kapasitesi, 1/4 hava girişi, 0.85 kg

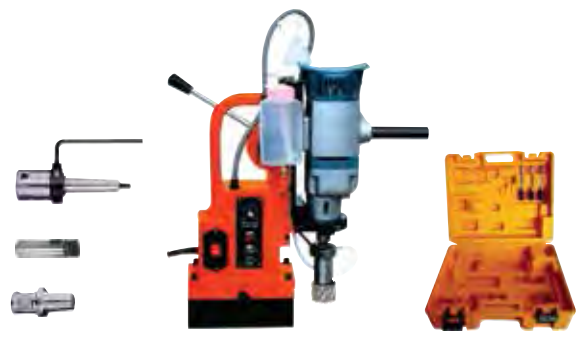

MD 45 Manyetik Matkap 720.- \$
1200 watt, 220~240 V ~ 50 Hz, Weldon bağlantı,
45 mm delme kapasitesi, 50 mm Delme derinliği,
100-500 dev/dk, 12000 N tork, 180 mm hareket boyu,
MT2 Weldon bağlantı, MT2 Mors konik, Pin,
hareketli tabla, 22 kg, Plastik kutuda,
Koli Adedi: 1



Weldon Sap Kesici Uçlar (Manyetik Matkaplar için)		
35 mm Kesme derinliği		
10 mm	61280	21.30 \$
12 mm	61282	21.30 \$
13 mm	61283	22.30 \$
14 mm	61284	22.80 \$
15 mm	61285	23.40 \$
16 mm	61286	24.00 \$
17 mm	61287	24.60 \$
18 mm	61288	25.10 \$
19 mm	61289	26.40 \$
20 mm	61290	27.10 \$
21 mm	61291	25.50 \$
22 mm	61292	28.50 \$
23 mm	61293	29.40 \$
24 mm	61294	30.60 \$
25 mm	61295	32.10 \$
26 mm	61311	35.70 \$
30 mm	61313	49.60 \$
32 mm	61314	57.00 \$
34 mm	61315	58.80 \$
35 mm	61316	60.90 \$
40 mm	61317	79.50 \$
45 mm	61319	103.20 \$
50 mm	61321	116.40 \$
60 mm	61328	131.10 \$

Weldon Sap Kesici Uçlar (Manyetik Matkaplar için)		
55 mm Kesme derinliği		
12 mm	61342	28.20 \$
13 mm	61343	28.50 \$
14 mm	61344	31.60 \$
15 mm	61345	34.20 \$
16 mm	61346	35.30 \$
18 mm	61348	36.00 \$
20 mm	61350	39.30 \$
22 mm	61352	40.50 \$
24 mm	61354	44.70 \$
25 mm	61355	45.60 \$
26 mm	61356	50.40 \$
28 mm	61358	54.10 \$
30 mm	61360	58.80 \$
32 mm	61362	67.80 \$
34 mm	61356	75.90 \$
35 mm	61365	81.10 \$
40 mm	61370	90.60 \$
44 mm	61374	105.40 \$
45 mm	61375	111.60 \$
50 mm	61380	157.80 \$
58 mm	61388	165.60 \$
60 mm	61390	174.00 \$

Weldon Uç Merkezleme Pimi		
8x103 mm - Uzun	61411	9.20 \$
8x90 mm - Kısa	61410	8.40 \$



SPA 20 K Elektroponomatik Kırıcı - Delici 120.80 \$

920 watt, SDS Plus sistem, 3 m kablo boyu,
Delme + Darbe + Kırıcı Toplam 3 fonksiyon
1 Ad. SDS Plus Yassi Keski,
1 Ad. SDS Plus Sivri Keski
1 Ad. 12x160 SDS Plus Matkap ucu,
1 Ad. 16x250 SDS Plus Matkap ucu
1 Adet 18x250 SDS Plus Matkap ucu
Toplam 2 Adet Keski + 3 Adet SDS Plus Matkap Ucu,
13 mm anahtarlı mandren ve mandren adaptörü ile
beraber plastik kutuda, 3.4 kg
Koli Adedi: 3



PB 45 K Elektroponomatik Kırıcı 508.80 \$

1500 watt, 240 V-50 Hz, 50 Joule,
1400 darbe/dak, 16 kg, 2 Adet kırıcı uç
ile beraber Plastik kutu içerisinde
Koli Adedi: 1



PB 48 K Elektroponomatik Kırıcı 639.60 \$

1850 watt, 240 V, 50 Hz, 55 joule,
1500 darbe/dak, 17 kg, 2 Adet kırıcı uç ile
beraber tekerlekli plastik kutu içerisinde
Koli Adedi: 1



PCS 180 K Daire Testere 158.- \$

180 mm, 1500 watt, laser klavuz ışığı,
Elmas testere, plastik kutu içerisinde
Koli Adedi: 2, 5.9 kg



PSS 185 Portatif Metal Kesici 228.- \$

185 mm, 1300 watt, 3500 d/dak.
metal kesen özel elmas testere ile beraber
plastik kutu içinde 12 mm e kadar çelik keser,
185x2.1mm, iç delik:20mm, 6.5 kg
Koli Adedi: 2

Metal Kesici Özel Elmas Testere 31.60 \$

185 mm,



DCDV 255 Karot Delme Makinası 1 041.- \$

2600 watt, 460-900 d/dak. 255 mm max. delik çapı,
Çift devir, A model ayak, 25.2 kg
Koli Adedi: 1



WXZ-1 Vakum Pompası 392.- \$

120 watt, 1Lt/sn, 12 Kg

Euromax EX75007 Vakum Tablası 105.- \$



PSB 250 Titreşim Zımpara 68.40 \$

320 watt, 115x275 mm,
Koli Adedi: 5, 1000-6000 d/dak, 3 kg



SD 660 Dekopaj Testere 69.- \$

500 watt, 60 mm,
500-3000 d/dak elektronik hız ayarı, 5 kg
Koli Adedi: 5



LD 5 Laminat Düzeltme 32.30 \$

450 watt, 30000 d/dak, 1.5 kg
Koli Adedi: 4



HK 400 Hava Körüğü 25.00 \$

380 watt, 2.5 m³/dak, 1.3 kg
Koli Adedi : 6



MEM 25 Metal Yazı Makinası 10397 11.90 \$

20 watt, 240 Volt

Plastik, ahşap, alüminyum, bakır, çelik yüzeylerin
üzerine titreşim yaparak çeşitli yazı ve markalama
işlerinde kullanılır.



Elle Sıkma Mandrenler

10 mm B 12	2724	22.00 \$
13 mm B 16	2725	24.00 \$
16 mm B 16	2726	30.50 \$
16 mm B 18	2727	30.50 \$
20 mm B 22	2728	46.00 \$
10 mm 3/8x24	50109	22.00 \$
10 mm 1/2x20	50110	22.00 \$
13 mm 3/8x24	50115	24.00 \$
13 mm 1/2x20	50116	24.00 \$
16 mm 1/2x20	50123	30.00 \$



Anahtarlı Mandrenler

10 mm B 12	2720	8.50 \$
10 mm 3/8x24	2716	2.70 \$
10 mm 1/2x20	2715	2.70 \$
13 mm 3/8x24	2718	3.10 \$
13 mm 1/2x20	2717	3.10 \$
13 mm B 16	2721	10.00 \$
16 mm 1/2x20	2719	6.00 \$
16 mm B 18	2722	10.80 \$
20 mm B 22	2723	18.00 \$
13 mm 1/2x20	MU2500	3.90 \$



Mandren Anahtarı

10 - 13 mm	2790	0.53 \$
16 mm	2791	0.83 \$
20 mm	2792	1.25 \$



Pratik Mandrenler (Plastik Gövde)

10 mm 1/2x20	2730	2.50 \$
10 mm 3/8x24	2731	2.50 \$
13 mm 3/8x24	2733	3.90 \$
13 mm 1/2x20	2732	3.90 \$

Pratik Mandrenler (Plastik Gövde)

10 mm 3/8x24	MU2510	3.00 \$
13 mm 1/2x20	MU2520	4.15 \$



Kilitli Pratik Mandrenler (Metal Gövde)

10 mm 3/8x24	2741	8.45 \$
13 mm 3/8x24	50011	8.45 \$
13 mm 1/2x20	2742	10.50 \$

Pratik Mandrenler (Metal Gövde)

10 mm 3/8x24	MU2530	9.15 \$
13 mm 1/2x20	MU2540	11.60 \$



Mini Mandren

0.5 - 3.5 mm Küçük	2745	5.10 \$
0.5 - 6 mm Büyük	2746	5.75 \$



Boya Tabancası Altın Depolu

1000 cc, 1.8mm	MK1301	12.50 \$
1000 cc, 2.0mm	MK1301-1	12.50 \$
1000 cc, 2.5mm	MK1301-2	12.50 \$
1000 cc, 3.0mm	MK1301-3	12.50 \$

Boya Tabancası MK1303

Altın depo Profesyonel		
1000 cc, 1.7 mm		35.00 \$



Boya Tabancası MK1302

Üstten depo Profesyonel		
600 cc, 1.3 mm		30.00 \$

Boya Tabancası

Üstten Depolu		
1.8mm	MK1300	11.00 \$
2.0mm	MK1300-1	11.00 \$
2.5mm	MK1300-2	11.00 \$
3.0mm	MK1300-3	11.00 \$

Boya ve Hava Tabanca Seti

5 parça	MK1304	30.00 \$
---------	--------	----------



Lastik Şişirme Tabancası

Saatli	MK1296	8.00 \$
--------	--------	---------



Metal Hava Tabancası

Uçsuz	MK1288	3.30 \$
Kısa Uç	MK1290	3.80 \$
Uzun Uç	MK1292	4.50 \$



Mazot Tabancası

900 cc	MK1298	8.50 \$
--------	--------	---------



Kalem Havya Craft

40 watt	MK0412	3.90 \$
60 watt	MK0413	4.30 \$



Kalem Havya Süper

40 watt	MK0414	5.35 \$
60 watt	MK0415	5.75 \$
80 watt	MK0416	7.65 \$
100 watt	MK0417	9.10 \$



Lehim Tabancası

100 watt	MK0420	18.00 \$
----------	--------	----------



7.3mm İnce Silikon

Mum Tabancası		
10 watt	MK0430	3.40 \$
20 watt	MK0432	3.90 \$

11.3mm Kalın Silikon

Mum Tabancası		
40 watt	MK0434	5.40 \$
60 watt	MK0436	5.70 \$
80 watt	MK0438	8.00 \$



Silikon Çubuk

11.3x300 mm Şeffaf	10.00 \$/kg
7.3 x300 mm Şeffaf	10.00 \$/kg
Elektrikli uhu tabancaları için yapıştırıcı çubuklar. 25 kg'lık kutularda satılır.	



Mekanik Zimba Tabancası

4-14 mm zimba	MK1280	11.30 \$
---------------	--------	----------

Zimba Tabancası

24/6-8 mm	MK1270	8.10 \$
-----------	--------	---------

13/6 Zimba Teli

5000 Adet/paket	MK1281	1.70 \$
-----------------	--------	---------

13/8 Zimba Teli

5000 Adet/paket	MK1282	2.00 \$
-----------------	--------	---------

13/8 Zimba Teli

5000 Adet/paket	MES 644	3.20 \$
-----------------	---------	---------

24/6 Zimba Teli

5000 Adet/paket		4.00 \$
-----------------	--	---------

13/4 Zimba Teli

5000 Adet/paket		2.10 \$
-----------------	--	---------



Mini Matkap 10 mm MES 100 40.- \$
550 watt



Darbeli Matkap 13 mm MES 112 40.- \$
780 watt



Tilki Kuyruğu (Kılıç Testere) MES 107 87.- \$
105mm, 750 watt



SDS Plus Kırıcı Delici Matkap MES 8999 110.- \$
800 watt, 26 mm



Darbeli Matkap MES 116 40.- \$
13 mm, 1000 watt



Sunta Kesme Makinesi MES 108 73.15 \$
1050 watt, 185 mm



Şarjlı Tornavida Seti MES 141 25.58 \$
37 parça, dönerli gövde



Avuç Taşlama Makinesi 115 mm MES 102 40.- \$
780 watt, 115 mm



Avuç Taşlama Makinesi 230 mm MES 106 127.- \$
2400 watt, 230 mm



Taşlama Makinası Devir Ayarlı MES 118 51.- \$
125 mm, 900 watt

Avuç Taşlama Makinası MES 117 42.- \$
115 mm, 550 watt



Dekupaj Makinası MES 109 44.13 \$
500 watt, 55 mm



Elektrikli Planya MES 119 69.13 \$
500 watt, 82x1 mm



Darbeli Akülü Vidalama MES 801 71.74 \$
10 mm, 18V, 1.5 Ah



1/2 Havalı Somun Sökme MES 3211 100.- \$
1/2", 16 mm somun, 8000 rpm, 660 Nm
max devir, 180 Lt/Dk 6.3-8.0 atü çalışma
basıncı, 1/4" hava girişi



1/2 Havalı Cırcır Kolu MES 3210 46.86 \$
1/4" kaplin, 160 d/d devir, 140 Lt/Dk, 7
kg/s tork, 1.2 kg



Boya Karıştırıcı MES 5530 87.50 \$
2400 watt, 220 V



Matkap Spiral Hilti El Aletleri
16'lı set MES 960 8.70 \$



Akaryakıt Mazot Pompası Mini
12V, 38 mm MK4940 10.30 \$
12V, 51 mm MK4950 13.20 \$
14V, 51 mm MK4960 13.20 \$



Akaryakıt Mazot Pompası
12V MK4970 52.20 \$
24V MK4980 52.20 \$

Akaryakıt Mazot Pompası Elektrikli
220 Volt, 240 Watt MK4990 58.50 \$



Plastik Mazot Pompası
OZPK00501 3.50 \$



Tezgah Üstü Zımpara Taş Motoru
150 mm MES 934 91.52 \$
175 mm MES 933 112.40 \$
200 mm MES 932 115.40 \$



Mazot Pompası
12 Volt, 200 watt MES 5503 58.15 \$
24 Volt, 60 watt MES 5504 58.15 \$



Mazot Pompası
12 Volt, 51 mm MES 5500 14.60 \$
12 Volt, 38 mm MES 5502 14.48 \$
24 Volt, 51 mm MES 5501 14.60 \$



Su Dinamosu MES 9791 53.72 \$
0.37 kw, 0.5 hp



Su Dinamosu MES 9792 117.50 \$
0.75 kw, 1.0 hp



Su Dinamosu MES 9794 202.00 \$
1.50 kw, 2.0 hp



Su Dinamosu JET MES 9793 128.45 \$
0.75 kw, 1.0 hp



Otomatik Hidrofor Hidromat
220 V- 240 W MES 114 50.00 \$



Dalgıç Kirli Su Pompa
400 W MES 136 79.60 \$
900 W MES 135 101.37 \$

Dalgıç Temiz Su Pompa
400 W MES 137 79.60 \$



41 Parça Gravür Taşlama Seti
135 watt MES 926 47.82 \$



210 Parça Gravür Taşlama Seti
135 watt MES 924 75.65 \$



234 Parça Gravür Taşlama Seti
135 watt MES 927 65.22 \$



245 Parça Gravür Taşlama Seti
135 watt MES 925 108.70 \$

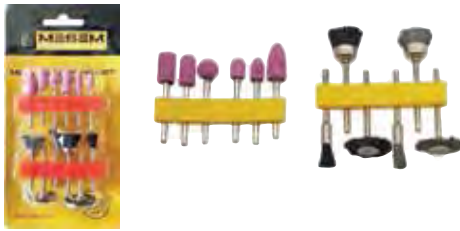

Gravür Seti 12 Parça MES 4151 4.5 \$
6 adet aşındırıcı taş, 6 adet tel fırça.
Dremel, Proxon gibi aletler için uygundur.



Gravür Seti 105 Parça MES 4580 6.12 \$
6 adet aşındırıcı taş, 6 adet tel fırça.
Dremel, Proxon gibi aletler için uygundur.



Benzinli Ağaç Kesme Motoru
52 cc MES 7511 173.92 \$
2.2 kW, 8500 R/min, 2800-3200 rpm, 18 inç, 45 cm

Benzinli Ağaç Kesme Motoru
53 cc RG 5300 190.00 \$
2.0 kW, 8500 R/min, 2800-3200 rpm, 18 inç, 45 cm



Benzinli Kütük Kesim Zinciri

3/25 - 1.3 mm - 34 T	MK1870	7.40 \$
3/25 - 1.3 mm - 36 T	MK1871	7.80 \$
3/25 - 1.3 mm - 38 T	MK1872	8.20 \$
3/8 - 1.3 mm - 34 T	MK1890	9.70 \$
3/8 - 1.3 mm - 36 T	MK1891	10.30 \$



Elektrikli Kütük Kesim Zinciri

91 - 1.3 mm - 27.5 T	MK1850	5.50 \$
91 - 1.3 mm - 28 T	MK1851	5.80 \$
91 - 1.3 mm - 28.5 T	MK1852	6.30 \$

Motorlu Testere Zincirleri

3/8 x 0.50 - 68 Diş	MES 1917	13.15 \$
3/8 x 0.50 - 72 Diş	MES 1918	13.90 \$



Motor Kaması

20", 1.5 mm, 3/25-76	MES 7514	10.13 \$
20", 1.5 mm, 3/8-68	MES 7515	10.13 \$
20", 1.5 mm, 3/8-72	MES 7516	11.96 \$



Mini Akülü Zincirli Testere
21 V, 2.0 Ah, çift akülü, MES 5540 88.- \$



Havalı Matkap 10 mm 09001 41.25 \$
10 mm, 1800 d/dak , 113 Lit/dak,
1 kg, Koli Adedi: 10



Havalı Düz Tip Tornavida 09101 57.10 \$
1/4" Hava giriş başlığı, 113 Lit/dak, 1 kg
Koli Adedi: 10



Havalı Tornavida Tabanca Tip 09121 52.60 \$
1800 d/dak, 113 Lit/dak, 1.2 kg
Koli Adedi: 10



Havalı Tornavida Tabanca Tip 09122 73.60 \$
Dıştan Tork ayarlı,0- 1800 d/dak, 1.4 kg,
113 Lit/dak



Havalı Kalıpcı Taşlama 09151 17.90 \$
2200 d/dak, 6 mm tutucu, 0.7 kg
113 Lit/dak , Koli Adedi: 10



Havalı Somun Sıkma 1/2 09051 36.90 \$
7000 d/dak,310 Nm, 113 Lit/dak, 1/4 Hava giriş
2.5 kg, Koli Adedi: 10



Havalı Somun Sıkma 3/4 09055 95.20 \$
4500 d/dak,678 Nm, 339 Lit/dak, 1/4 Hava giriş
4.6 kg, Koli Adedi: 5



Havalı Somun Sıkma 1/2 09052 87.50 \$
7000 d/dak,407 Nm, 113 Lit/dak, 1/4 Hava giriş, 2.5 kg



Havalı Somun Sıkma 1' Uzun Tip 09061 338.- \$
4000 d/dak,1898 Nm, 282 lit/dak,600 mm, 19 kg,
1/2 Hava giriş, Koli Adedi: 1



Havalı Somun Sıkma 1' Kısa Tip 09060 312.40 \$
4000 d/dak,1898 Nm, 282 lit/dak,600 mm, 19 kg,
1/2 Hava giriş, Koli Adedi: 1



Havalı Cırcır 1/2 09351 36.40 \$
160 d/dak,69 Nm, 113 Lit/dak, 1/4 Hava giriş, 1.2 kg



Havalı Avuç Taşlama 09551 76.60 \$
100 mm, 11000 d/dak, 169 Lit/dak, 1.7 kg



Havalı Avuç Taşlama 09561 54.60 \$
125 mm 11000 d/dak,169 Lit/dak, 1.8 kg



Havalı Ekzantrik Zımpara Profesyonel 09521 125.00 \$
150mm,12000 d/dak, 113 Lit/dak, 1/4 hava giriş, 1.2 kg



JEX24 Havalı Raspa 09701 109.- \$

Havalı Raspa İğnesi 09702 16.- \$
100 Adet/paket



Kuletaş Kompresörler

24 Lt - 2 HP	187.95 \$
50 Lt - 2 HP	218.70 \$
100 Lt - 2 HP	694.00 \$
200 Lt - 3 HP	989.00 \$
300 Lt - 5.5 HP	2090.00 \$
500 Lt - 5.5 HP	2188.00 \$
500 Lt - 10 HP	2560.00 \$



Sessiz Hava Kompresörleri

9 Lt - 1 HP	215.50 \$
24 Lt - 1 HP	257.60 \$
35 Lt - 1 HP	353.20 \$
50 Lt - 1.5 HP	343.50 \$
60 Lt - 2 HP	496.10 \$
100 Lt - 3 HP	818.10 \$
150 Lt - 4 HP	1130.80 \$
200 Lt - 4 HP	1313.60 \$



Kabinli Sessiz Hava Kompresörleri

30 Lt - 1.5 HP	1211.80 \$
60 Lt - 2 HP	1433.70 \$

Sessiz Kompresör Motoru

1 HP	178.20 \$
1.5 HP	259.20 \$



1832 Havalı Başsız Çivi Tabancası 9661 32.50 \$
TPIN başsız çivi, 4-7 bar, 10-32 mm arası çivi atma kapasitesi, 1/4" hava girişi, 1 kg

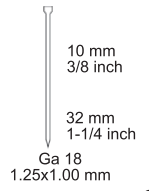

9655 Havalı Başlı Çivi Tabancası 09655 36.80 \$
TPIN başlı çivi, 4-6 bar, 18-50 mm arası çivi atma kapasitesi, 1/4" hava girişi, 1 kg

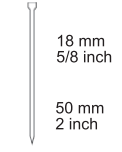

8016 Havalı Zimba Tabancası 09651
12.8x4 - 14 mm zimba teli, 4.7 bar, 120 adet zimba kapasitesi, 1/4" hava girişi, 0.85 kg

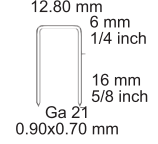

AM3 Hızlı Bağlantı Merkezi 09801 7.10 \$



Lastik Şişirme Tabancası 09701

OSCO Hava Kompresörü

2.5 HP - 1.5 Kw, 50 Lt, 94 dB, 210 L/dk, 8 bar, 34 kg, Koli adedi : 1

188.- \$

Dalgakıran Hava Kompresörü

2.5 HP - 1.5 Kw, 100 Lt, 94 dB, 210 L/dk, 8 bar, Koli adedi : 1

10 770.- TL



Kuletaş Kompresörler

24 Lt - 2 HP	187.95 \$
50 Lt - 2 HP	218.70 \$
100 Lt - 2 HP	694.00 \$
200 Lt - 3 HP	989.00 \$
300 Lt - 5.5 HP	2090.00 \$
500 Lt - 5.5 HP	2188.00 \$
500 Lt - 10 HP	2560.00 \$



Sessiz Hava Kompresörleri

9 Lt - 1 HP	215.50 \$
24 Lt - 1 HP	257.60 \$
35 Lt - 1 HP	353.20 \$
50 Lt - 1.5 HP	343.50 \$
60 Lt - 2 HP	496.10 \$
100 Lt - 3 HP	818.10 \$
150 Lt - 4 HP	1130.80 \$
200 Lt - 4 HP	1313.60 \$



Kabinli Sessiz Hava Kompresörleri

30 Lt - 1.5 HP	1211.80 \$
60 Lt - 2 HP	1433.70 \$

Sessiz Kompresör Motoru

1 HP	178.20 \$
1.5 HP	259.20 \$



9661

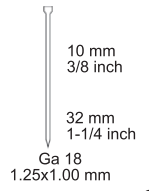

1832 Havalı Başsız Çivi Tabancası 9661 32.50 \$
TPIN başsız çivi, 4-7 bar, 10-32 mm arası çivi atma kapasitesi, 1/4" hava girişi, 1 kg



9655

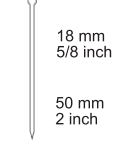

9655 Havalı Başlı Çivi Tabancası 09655 36.80 \$
TPIN başlı çivi, 4-6 bar, 18-50 mm arası çivi atma kapasitesi, 1/4" hava girişi, 1 kg

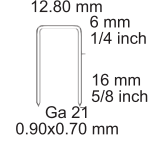

8016 Havalı Zimba Tabancası 09651
12.8x4 - 14 mm zimba teli, 4.7 bar, 120 adet zimba kapasitesi, 1/4" hava girişi, 0.85 kg



AM3 Hızlı Bağlantı Merkezi 09801 7.10 \$



Lastik Şişirme Tabancası 09701

OSCO Hava Kompresörü

2.5 HP - 1.5 Kw, 50 Lt, 94 dB, 210 L/dk, 8 bar, 34 kg, Koli adedi : 1

188.- \$

Dalgakıran Hava Kompresörü

2.5 HP - 1.5 Kw, 100 Lt, 94 dB, 210 L/dk, 8 bar, Koli adedi : 1

10 770.- TL



Planya ve Kalınlık Makinası

HAİS MB Y8 558.90 \$
HAİS MB Y10 793.80 \$
HAİS MB Y12 328.40 \$



Ahşap Şerit Testere

HAİS MJ 10 680.90 \$
HAİS MJ 12 1028.80 \$
HAİS MJ 14 1441.40 \$



Toz Emme Makinası

SPA1200 419.60 \$



Bant ve Disk Zımpara Makinası

HAİS 1063 265.70 \$



Kalınlık Makinası MB13

HAİS 1064 769.50 \$



Kıl Testere Makinası

HAİS 1065 273.80 \$



Basıncı Su Yıkama Makinası

LT 501 202.05 \$
1800 w, 150 bar, 7 litre

Basıncı Su Yıkama Makinası

LT 601 GW 274.60 \$
1900 w, 170 bar, 7.5 litre



Ahşap Torna Makinası

305 mm 434.20 \$

Ahşap Torna Makinası

457 mm 664.20 \$

Ahşap Torna Makinası

1100 mm 1530.90 \$



Tezgah Testere

HAİS 225A 315.90 \$



Sütunlu Matkap

13 mm 186.30 \$
16 mm 469.80 \$



Sütunlu Matkap

25 mm ZJ4125-1 834.30 \$
32 mm ZJ4132-1 1375.40 \$



1'' Uzun Havalı Somun Sökme
4841033 451.98 \$



Havalı Ekzantrik Zımpara
EP6151-6-S 71.28 \$



Tek Kol El Freze

700 Watt 178.60 \$
JL3601



Akü Şarj Cihazı

CB-10E-1 64.70 \$
6-12 Volt



Akü Şarj Cihazı

CB-15S 88.30 \$
12-24 Volt



Akü Şarj Cihazı

FC-16E 139.65 \$
12-24 Volt



Akü Şarj Cihazı

PRO 4.0 46.98 \$
6-12 Volt



Uzun Kalıpcı Taşlama
BDG 1004 ZB 63.70 \$



Kısa Kalıpcı Taşlama
BDG 1004 ZA 55.10 \$



Kanal Açma Makinesi 2000 W
CV352000 427.70 \$



Radyal Gönye Kesme Testere
255 mm 405.00 \$
HM 1030A



Radyal Gönye Kesme Testere
305 mm 567.00 \$
HM 1247A



Gönye Kesim Testere
210 mm 161.00 \$
HM9083A



Darbeli Matkap
13 mm, 800 Watt 51.85 \$
JL1630



Darbesiz Matkap
10 mm, 580 Watt 37.50 \$
JL6001



Darbesiz Matkap 37.50 \$
10 mm, 710 Watt. metal mandren
6110A



Akülü Matkap 18 Volt 85.40 \$
CD-LBT-16A



Tilki Kuyruğu Testere 80.00 \$
900 Watt
HT7601 IT



Sunta Kesme 79.40 \$
1200 watt
JL5800



Kırıcı Delici Matkap 103.70 \$
26 mm, 800 Watt
Z1A-2601SRE



Kırıcı Delici Matkap 432.55 \$
1500 Watt, 10.1 kg
Z1C-ZT2-52



Kırıcı Delici Matkap 497.35 \$
1750 Watt, 16 kg
BDH1600X01



Büyük Taşlama 136.10 \$
180 mm, 2200 Watt
BAG 1008



Polisaj Makinası 118.30 \$
180 mm, 1300 Watt
MB7801



Boya ve Harç Karıştırıcı 88.50 \$
1300 Watt
JL1636



Boya ve Harç Karıştırıcı 127.95 \$
1600 Watt
ZY-HM-1301S

Boya ve Harç Karıştırıcı 192.80 \$
1600 Watt
ZY-HM-1401S



GBM 6 RE Darbesiz Matkap
350 watt, 10 mm çap, 1300 d/dak,
sağ-sol

76.00 €



GSB 13 RE Darbeli Matkap
600 watt, 13 mm çap, iki hız

98.00 €



GSB 16 RE Darbeli Matkap
750 watt, 13 mm çap

153.00 €



GSB 21-2 RCT Darbeli Matkap
1800 watt, 13 mm çap, iki hız



GGS 28 CE Kalıpcı Taşlama Kısa
650 watt, 28000 d/dak, 1.4 kg

210.00 €



GGS 28 LCE Kalıpcı Taşlama Uzun
650 watt, 28000 d/dak, 1.6 kg

304.00 €



GWS 7-115 Avuç Taşlama
720 watt, 115 mm, 11000 d/dak

91.00 €

GWS 750 Avuç Taşlama
750 watt, 115 mm, 11000 d/dak

85.00 €

GWS 750-S Avuç Taşlama
750 watt, 115 mm, 2800-11000 d/dak

104.00 €

GWS 9-115 Avuç Taşlama
900 watt, 115 mm, 11000 d/dak

123.00 €

GWS 9-115-S Avuç Taşlama
900 watt, 115 mm, 2800-11000 d/dak

136.00 €

GWS 17-125 CS Avuç Taşlama
1700 watt, 125 mm, 2800-11500 d/dak

212.00 €



GWS 2200-180 H Büyük Taşlama
2200 watt, 180 mm, 8500 d/dak

184.00 €

GWS 2200-230 H Büyük Taşlama
2200 watt, 230 mm, 6500 d/dak

184.00 €

GWS 24-180 JZ Büyük Taşlama
2400 watt, 180mm, 8500 d/dak

240.00 €

GWS 24-230 JZ Büyük Taşlama
2400 watt, 230 mm, 6500 d/dak

240.00 €

GWS 30-180 B Büyük Taşlama
2800 watt, 180 mm, 8500 d/dak

392.00 €

GWS 30-230 B Büyük Taşlama
2800 watt, 230 mm, 6500 d/dak

392.00 €



GST 150 CE Dekopaj
780 watt, 150 mm

261.00 €



GOF 1600 CE Freze
1600 watt, 25000 d/dak

GOF 1250 CE Freze
1250 watt, 24000 d/dak



GBH 2/26 DRE Kırıcı-Delici Matkap 222.00 €
800 watt, 26 mm çap, kırıcı-delici SDS



GSR 120 Li Akülü Delme Vidalama 154.00 €
2 Akülü, 2 Amper



GBH 5/40 D Kırıcı-Delici Matkap 593.00 €
1050 watt, 38 mm çap, SDS Max

GSR 180 Li Akülü Vidalama 216.00 €
2 Akülü, 2 Amper



GBH 8/45 D Kırıcı-Delici Matkap 952.00 €
1500 watt, 45 mm çap, 8.2 kg, 12.5 Joule, SDS Max



GSR 18V-50 Akülü Matkap Vidalama 278.00 €
2 Akülü, 2 Amper



GSH 11 E Elektropnömatik Kırıcı 887.00 €
1500 watt, 6-25 Joule, 10 kg, SDS Max

GSR 18V-50 Akülü Matkap Vidalama 407.00 €
2 Akülü, 5 Amper



GSB 18V-50 Darbeli Akülü Matkap 288.00 €
2 Akülü, 2 Amper



GKS 190 Sunta Kesme 160.00 €
1050 watt, 184 mm, 4800 d/dak, 66 mm

GSB 18V-50 Darbeli Akülü Matkap 424.00 €
2 Akülü, 5 Amper



GLM 40 Uzaklık Ölçme (Lazer 40 m) 89.00 €
GLM 50-27 Uzaklık Ölçme (Lazer 50 m) 150.00 €



ARM 32 Çim Biçme Makinası 127.00 €
Kesme yüksekliği 20-60 mm



Darbesiz Matkap MK0010 33.50 \$
500 watt, 10 mm çap, plastik mandren, sağ-sol dönerli



Darbesiz Matkap MK0015 35.00 \$
550 watt, 10 mm çap, plastik mandren, sağ-sol dönerli



Darbeli Matkap MK0020 34.50 \$
500 watt, 13 mm çap, metal mandren, sağ-sol dönerli



Darbeli Matkap MK0025 35.00 \$
780 watt, 13 mm çap, plastik mandren, sağ-sol dönerli



Avuç Taşlama MK0030 34.20 \$
580 watt, 115 mm



Avuç Taşlama MK0035 39.00 \$
780 watt, 115 mm, 13mm çap



Sıcak Hava Tabancası MK0086 25.30 \$
2000 watt, 350-550 C°



Sıcak Hava Tabancası 7540 28.00 \$
2000 watt,



Avuç Taşlama MK0040 53.00 \$
125 mm, 1200 watt, 125 mm çap, 90 derece döner kolu



Jet Taşlama MK0050 74.00 \$
180 mm, 1400 Watt

Jet Taşlama MK0060 104.00 \$
230 mm, 2400 watt, 90 derece döner kolu



Kırcı Delici Matkap 26 mm MK0090 68.50 \$
800 watt, 26 mm çap, 230 V, 50 Hz, 0-1450 devir/dak, 4 fonksiyonlu, 5900 vuruş, 2.8 joule, 2.8 kg



Kırcı Delici Matkap SDS Plus MK0095 110.00 \$
1600 watt, 32 mm çap, 230 V, 50 Hz, 0-800 / 0-4000 devir, 4 fonksiyonlu



Kırcı Delici Matkap SDS Plus MK0098 237.00 \$
1500 watt, 65 mm çap, 2 uçlu



Kırcı Hilti MES 111 286.- \$
1500 watt



Şarjlı Vidalama KLN3613 25.00 \$
3.6 V, 1.5 Ah Lion, 3.5 Nm tork, 200 dev/dk,
1/4" mandren, 44 parça aksesuar seti

Şarjlı Darbesiz Vidalama KLN1020 83.00 \$
10.8 V, 2.0 Ah Lion, 30 Nm tork, 0-350/0-1300
dev/dk, 10mm mandren, çift akü



Şarjlı Darbesiz Vidalama KLN1020S 103.00 \$
10.8 V, 2.0 Ah Lion, 30 Nm tork, 0-350/0-1300 dev/dk,
10mm mandren, çift akü, vidalama için çıkabilen
mandren, köşe ve kenar vidalama adaptörü, led
fenerli akü



Şarjlı Çift Akülü Multi Set KLMS18-20 200.00 \$
18 V, 2.0 Ah Lion, çift akülü
Darbeli Vidalama; 25Nm, 20+3 tork, 10mm mandren
Daire Destere; 0-4000 dev/dk, 85mm bıçak, 15mm
max kesme derinliği, Dekupaj Testere; 2200 dev/dk



**Akülü Profesyonel
Kömürsüz Vidalama** KLDV18B-20 150.00 \$
18 V, 2.0 Ah Lion, 180 Nm tork, 0-2200 dev/dk, 0-3300
dar/dk, Max somun çapı 6 mm, iki akülü, çantalı



Akülü Darbesiz Vidalama KLN18-20 114.00 \$
18 V, 2.0 Ah Lion, 40 Nm tork, 0-35/0-1200
dev/dk, 13mm mandren, çift akülü, çantalı



**Profesyonel
Akülü Darbesiz Vidalama Kömürsüz** KLN18B-20 145.00 \$
18 V, 2 Ah, 60 Nm, 0-500 / 0-1800 dev/dak, 13 mm
mandren, çift akü, çantalı

**Profesyonel
Akülü Darbesiz Vidalama Kömürsüz** KLN18B-50 222.00 \$
18 V, Ah, 60 Nm, 0-500 / 0-1800 dev/dak, 13 mm
mandren, çift akü, çantalı



**Akülü Profesyonel
Darbeli Matkap** KLD18-20 119.00 \$
18 V, 2.0 Ah Lion, 40 Nm tork, 0-500/0-1800
dev/dk, 13mm mandren, çift akülü, çantalı



**Profesyonel
Akülü Darbeli Matkap Kömürsüz** KLD18B-20 150.00 \$
18 V, 2 Ah, 60 Nm, 0-500 / 0-1800 dev/dak, 13 mm
mandren, çift akü, çantalı

**Profesyonel
Akülü Darbeli Matkap Kömürsüz** KLD18B-50 227.00 \$
18 V, 5 Ah, 60 Nm, 0-500 / 0-1800 dev/dak, 13 mm
mandren, çift akü, çantalı



Akülü Profesyonel Kömürsüz Somun Sıkma KLSS18B20 162.00 \$
18 V, 2.0 Ah Lion, 250 Nm tork, 0-2200 dev/dk, 0-3300 dar/dk, 1/2" uç,
iki akülü, çantalı

18 V, 5.0 Ah Lion, KLSS18B50 239.00 \$
250 Nm tork, 0-2200 dev/dk, 0-3300 dar/dk, 1/2" uç,
iki akülü, çantalı

**Akülü Profesyonel Kömürsüz
Somun Sıkma** KLSS18BH 269.00 \$
18 V, 5.0 Ah Lion, 400 Nm tork, 0-2200 dev/dk,
0-3300 dar/dk, 1/2" uç, iki akülü, çantalı

**KL III PRO**

Profesyonel Darbesiz Matkap KLN1002 40.00 \$
600 W, 10 mm mandren, 0-3500 dev/dk,

Profesyonel Darbeli Matkap KLDM1305 50.00 \$
800 W, 13 mm mandren, 0-2800 dev/dk,



Profesyonel Alçıpan Tornavidası KLA160266 60.00 \$
500 W, 6 mm HEX vida çapı, 0-2050 dev/dk,

Profesyonel Somun Sıkma KLSS1901 90.00 \$
900 W, 2400 dev/dk, 320 Nm, M22 somun çapı, 1/2" uç kovanı



Profesyonel SDS Plus Kırıcı Delici KLPM2601 95.00 \$
850 W, 0-1100 dev/dk, 0-4200 dar/dak, 3.2 J darbe gücü, 26 mm delme kapasitesi, çantalı



Kalıpçı Taşlama Kısa KLKT505 49.00 \$
450 W, 27000 dev/dk, 6mm pens,

Kalıpçı Taşlama Uzun KLKT507 57.00 \$
450 W, 27000 dev/dk, 6mm pens,



Profil Kesim Makinesi KLPK1306 250.00 \$
2400 W, 3800 dev/dk, 355x25.4 mm disk çapı,

Profil Kesim Makinesi KLPK2506 195.00 \$
2500 W, 3800 dev/dk, 355x25.4 mm disk çapı,



Profesyonel Avuç Taşlama KLAT11505 48.00 \$
850 W, 115 mm disk çapı, 11000 dev/dk, 2 kg

Profesyonel Avuç Taşlama KLAT11502 40.00 \$
750 W, 115 mm disk çapı, 11000 dev/dk, 1.5 kg



Devir Ayarlı Profesyonel Avuç Taşlama KLAT11508 60.00 \$
1100 W, 125 mm disk çapı, 2800-11000 dev/dk, 1.5 kg

Devir Ayarlı Profesyonel Avuç Taşlama KLAT11511 60.00 \$
1100 W, 125 mm disk çapı, 2800-15000 dev/dk, 1.5 kg

Profesyonel Kömürsüz Devir Ayarlı Avuç Taşlama KLAT11509 222.00 \$
1150 W, 115 mm disk çapı, 3000/11500 dev/dk, 2.1 kg



Profesyonel Akülü Kömürsüz Avuç Taşlama KLAT18B-20 157.00 \$
18 V, 2 Ah Lion, 115 mm disk çapı, 0-8500 dev/dk, M14 mil bağlantı, çift akü,



Profesyonel Akülü Kömürsüz Avuç Taşlama KLAT18B-50 234.00 \$
18 V, 5 Ah Lion, 115 mm disk çapı, 0-8500 dev/dk, M14 mil bağlantı, çift akü,



Profesyonel Büyük Taşlama 180 mm KLBT83180 100.00 \$
2200 W, 180 mm disk çapı, 8000 dev/dk,

Profesyonel Büyük Taşlama 230 mm KLBT83230 100.00 \$
2200 W, 230 mm disk çapı, 8000 dev/dk,



Profesyonel Polisaj Makinası KLPJ2180 85.00 \$
1400 W, 180/230 mm disk çapı, 1000/3300 dev/dk, M14 mil bağlantı, yün keçe ve taban ile beraber



Profesyonel Taş Motoru 150 mm KLTM150 65.00 \$
250 W, 230V / 50 Hz, 2950 dev/dk, 150x20x12.7 mm taş çapı, 8.2 kg

Profesyonel Taş Motoru 175 mm KLTM175 75.00 \$
400 W, 230V / 50 Hz, 2950 dev/dk, 175x20x32 mm taş çapı, 9.5 kg

Profesyonel Taş Motoru 200 mm KLTM200 80.00 \$
400 W, 230V / 50 Hz, 2950 dev/dk, 200x20x32 mm taş çapı, 10.3 kg



Profesyonel Tilki Kuyruğu Testere KLTK0850 57.00 \$
850 W, 0-2800 dev/dk, 25 mm derinlik hareketi, hızlı bıçak değiştirme sistemi

Profesyonel Tilki Kuyruğu Testere KLTK1100 87.00 \$
1100 W, 0-2800 dev/dk, 28 mm derinlik hareketi, hızlı bıçak değiştirme sistemi



Profesyonel Planya KLPL1011 82.00 \$
850 W, 16500 dev/dk, 0.3 mm max derinlik



Çok Amaçlı Makina KLMT305 57.00 \$
300 W, 15000-22000 tit/dk, 5 parça aksesuar seti



Eksantrik Zımpara KLEZ43150 55.00 \$
450 W, 6000/12000 dev/dk, 150 mm kağıt ölçüsü,



Sıcak Hava Tabancası KLSH7303 34.00 \$
2000 W, 250 lt/dk 1.kademe hava, 500 lt/dk 2.kademe hava, 50-450 C 1.kademe sıcaklık, 60-650 C 2.kademe sıcaklık,



Gönye Kesim Makinesi KLGK1512 415.00 \$
1900 W, 4700 dev/dk, 255x24.5x30 mm bıçak çapı,



Manyetik Matkap KLSMM502 1 200.00 \$
1200 W, 180-300 / 270-1450 dev/dk, kesme çapı/derindiği 50 mm, Kesici uç tutucu 19 mm weldon şaft



Profesyonel Elektrikli Boya Tabancası KLBT15A 55.00 \$
400 Watt, 800 ml boya haznesi



Boya Karıştırıcı KLMX6212 235.00 \$
1600 W, 150-640 / 300-750 dev/dk, 2 vites, M14 uç tutucu, 140 lt karıştırma kapasiteli,



125/250 Elektrikli Vinç KLV125 100.00 \$
500 W, 230 V / 50 Hz, 125/250 kg kaldırma kapasitesi, 10/20 mt kaldırma yüksekliği, 11 kg

250/500 Elektrikli Vinç KLV250 145.00 \$
500 W, 230 V / 50 Hz, 250/500 kg kaldırma kapasitesi, 10/20 mt kaldırma yüksekliği, 17.6 kg

400/800 Elektrikli Vinç KLV400 175.00 \$
500 W, 230 V / 50 Hz, 400/800 kg kaldırma kapasitesi, 10/20 mt kaldırma yüksekliği, 20.4 kg

600/1200 Elektrikli Vinç KLV600 285.00 \$
500 W, 230 V / 50 Hz, 600/1200 kg kaldırma kapasitesi, 10/20 mt kaldırma yüksekliği, 33.8 kg



Basınçlı Su Yıkama KLY2000 160.00 \$
220 V, 50 Hz, 2000 Watt,
150 bar, 400 lt/saat



Lazer Mesafe Ölçer
50 mt KLLZM50 42.00 \$
80 mt KLLZM80 70.00 \$
80 mt KLLZM80T 64.00 \$
100 mt KLLZM100 80.00 \$



Kalem Havya
30 watt KLLKH30 8.00 \$
40 watt KLLKH40 9.00 \$
60 watt KLLKH60 10.00 \$



Kalem Havya KLLKH 80/40 13.00 \$
80/40 watt, 7 mm, 530 C

KL PRO



Çivi Zimba Tabancası KLZC6030E 34.00 \$
230 V, 50 Hz, 8-16 mm zimba uzunluğu, 15-16 mm çivi uzunluğu, 80 adet çivi - 100 adet zimba kapasiteli, 20 adet/dk vuruş hızı,

Elektrikli Çivi Zimba Çakma Tabancası KLZC6041E 55.00 \$
15-25 mm zimba uzunluğu, 15-32 mm çivi uzunluğu, 100 adet çivi - 100 adet zimba kapasiteli, 20 adet/dk vuruş hızı,



31 Parça Bits Uç Seti KLBS30A 4.00 \$
Torx Uç - T5, T6, T8, 2 x T10, 2 x T15, 2 x T20, T25,
Allen Uç - 2, 3, 4, 5, 6 mm,
Düz Uç - 2.5, 3, 4, 5, 6 mm,
Pozidriv Uç - PZ0, PZ1, PZ2, PZ3, PZ4,
Yıldız Uç - PH0, PH1, PH2, PH3, PH4,
Manyetik Uç Tutucu



44 Parça Delme Vidalama Seti KLUS44A 16.00 \$
Ahşap Delme Uç : 3, 4, 5, 6, 8 mm
Metal Delme Uç : 1, 1.5, 2, 2.5, 3, 3.5, 4, 4.5, 5, 5.5, 6mm
Beton Delme Uç : 4, 5, 6, 8 mm
Torx Uç : T10, T15, T20, T25, T27, T30, T40 mm, L = 25mm
Düz Uç : 4, 5, 6 mm, L=25 mm / 4, 5 mm, L= 50 mm
Pozidriv Uç - Pz0, Pz1, Pz2, Pz3, Pz4, L= 25 mm
Yıldız Uç - Ph1, Ph2, L= 50 mm Ph1, Ph2, Ph3, L= 25 mm
Manyetik Uç Tutucu
Ölçü Plastığı



Sıcak Mum Tabancası KLSMT830 16.00 \$
16 watt, max sıcaklık 200 derece, 11 mm mum çapı



Şarjlı Budama Makası KLBBM18B-20 177.00 \$
18V, 30 mm kesme kapasitesi, 2.Ah



24 LT Kompresör KLK25 160.00 \$
2 Hp, 230 V / 50 Hz, 8 bar / 116 psi basınç, 250 lt/dk, 24 lt tank, 2850 dev/dk

50 LT Kompresör KLK50 200.00 \$
2 Hp, 230 V / 50 Hz, 8 bar / 116 psi basınç, 250 lt/dk, 50 lt tank, 2850 dev/dk

100 LT Kompresör KLK100 475.00 \$
2 Hp, 230 V / 50 Hz, 8 bar / 116 psi basınç, 250 lt/dk, 100 lt tank, 2850 dev/dk



8 LT Kompresör KLK80S 160.00 \$
1 Hp, 230 V / 50 Hz, 8 bar, 131 lt/dk, 8 lt tank, 1400 dev/dk

25 LT Kompresör KLK25S 180.00 \$
1 Hp, 230 V / 50 Hz, 8 bar, 126 lt/dk, 24 lt tank, 1400 dev/dk

50 LT Kompresör KLK50S 220.00 \$
1 Hp, 230 V / 50 Hz, 8 bar, 126 lt/dk, 50 lt tank, 1400 dev/dk

100 LT Kompresör KLK103S 570.00 \$
3 Hp, 230 V / 50 Hz, 8 bar, 418 lt/dk, 100 lt tank, 1400 dev/dk



Havalı Ekzantrik Dairesel Zımpara KLHA603V6 43.00 \$
150 mm, 5/16"x24 UNF, 9000 dev/dak, 1/4 hava girişi



Temiz Su Dalgıç Pompa KLP550TE 55.00 \$
550 W, 10.75 Hp, 10.000 lt/saat, max basınç 0.85 bar, max yükseklik 85 mt

Kirli Su Dalgıç Pompa KLP550KE 58.00 \$
550 W, 10.75 Hp, 10.000 lt/saat, max basınç 0.7 bar, max yükseklik 7 mt



Paslanmaz Temiz Su Dalgıç Pompa KLP750IT 91.00 \$

750 W, 1 Hp, 230V, 50 Hz, 10.000 lt/saat, max basınç 0.8 bar, max yükseklik 8 mt

Paslanmaz Kirli Su Dalgıç Pompa KLP750KP 103.00 \$
750 W, 1 Hp, 230V, 50 Hz, 11.500 lt/saat, max basınç 0.8 bar, max yükseklik 7.5 mt



Havalı Gres Tabancası KLHA843 28.00 \$
500 cc, 1/4" hava girişi, 1.4 kg

Havalı Silikon Tabancası KLHA9907 19.00 \$
1/4" hava girişi

Havalı Pop Perçin Pensesi KLHA0810 58.00 \$
5 mm kapasite, 1/4" hava girişi, 2 kg



1/2" Havalı Darbeli Somun Sıkma KLHA 403 35.00 \$
340 Nm, 205 mm uzunluk, 7000 d/dak, tek çekiç, 1/4 hava giriş, 1/2 lokma, plastik kutu içinde, 2.2 kg

1/2" Havalı Darbeli Somun Sıkma Seti KLHA 403K 53.00 \$
340 Nm, 205 mm uzunluk, 7000 d/dak, tek çekiç, 1/4 hava giriş, 1/2 lokma, plastik kutu içinde, 2.2 kg



Sirkülasyon Pompası KLP25-6CP 38.00 \$
100 W, 1 Hp, 230V, 50 Hz, 2.7 m³/saat max akış hızı, max yükseklik 4 mt, 3/4" giriş çıkış bağlantısı

Sirkülasyon Pompası KLP25-7CP 56.00 \$
100 W, 1 Hp, 230V, 50 Hz, 3.1 m³/saat max akış hızı, max yükseklik 6 mt, 3/4" giriş çıkış bağlantısı





Eco Akülü Vidalama KE2213NM-DB 61.00 \$
12 V, 1.3 Ah Lion, 19 Nm tork, 0-700 dev/dk, 10mm mandren, çift akü

Eco Akülü Vidalama KE2220DM-DB 61.00 \$
12 V, 2.0 Ah Lion, 23 Nm tork, 0-350 0-1350 dev/dk, 10mm mandren, çift akü

Eco Akülü Vidalama KE2220DM 45.00 \$
12 V, 2.0 Ah Lion, 23 Nm tork, 0-350 0-1350 dev/dk, 10mm mandren, TEK akü

Eco Akülü Vidalama KE2213NM 38.00 \$
12 V, 1.3 Ah Lion, 19 Nm tork, 0-700 dev/dk, 10mm mandren, tek akü



Eco Akülü Vidalama KE18DM-20-DB 101.00 \$
18 V, 2.0 Ah Lion, 30 Nm tork, 0-350 /0-1250 dev/dk, 10mm mandren, çift akü, 16 parça aksesuar

Eco Akülü Vidalama KE18DM-15-DB 69.00 \$
18 V, 1.5 Ah Lion, 30 Nm tork, 0-350 /0-1250 dev/dk, 10mm mandren, çift akü, 42 parça aksesuar



Eco Avuç Taşlama KE75115AT 29.00 \$
750 W, 115 mm disk çapı, 1200 dev/dk,



Eco Sıcak Hava Tabancası KE7202SH 24.00 \$
2000 W, 300 lt/dk 1.kademe hava, 500 lt/dk 2.kademe hava, 450 C 1.kademe sıcaklık, 600 C 2.kademe sıcaklık,



Eco Dekupaj Testere KE4030DT 27.00 \$
400 W, 500/3000 dev/dk, 20mm derinlik,

KL III ECO



Eco Darbeli Matkap KE5513DM 27.00 \$
600 W, 0/3100 dev/dk, 13 mm



Eco Darbeli Matkap KE8226PM 70.00 \$
820 W, 0/3100 dev/dk, 13 mm



Eco Polisaj Makinası KE12180PS 61.00 \$
1200 W, 180 mm



Eco Daire Testere KE4185DAT 58.00 \$
1400 W, 185 mm



Eco Eksantirik Zımpara KE30125EZ 38.00 \$
300 W, 125 mm



Eco Kaynak Makinası KE160MMA 205.00 \$
220V, 50/60 Hz, 6.8kVA, 15-160A

HITACHI



Hitachi D10VC3 105.00 \$
Darbelsiz Matkap
600 Watt, 0-2500 dev/dk, 10 mm mandren



Hitachi DV13VST 68.00 \$
Darbelsiz Matkap
550 Watt, 0-3000 dev/dk, 10 Nm tork, 13 mm mandren



Hitachi DV18DD 320.00 \$
Akülü Darbelsiz Matkap Vidalama
18 V, 2 Ah Lion, 13 mm çelik delme çapı, 38 mm ahşap delme çapı, 13 mm tuğla delme çapı, 0-400/1700 dev/dk, 55 nm tork, 22 kademe

Hitachi DV18DD 460.00 \$
Akülü Darbelsiz Matkap Vidalama
18 V, 5 Ah Lion, 13 mm çelik delme çapı, 38 mm ahşap delme çapı, 13 mm tuğla delme çapı, 0-400/1700 dev/dk, 55 nm tork, 22 kademe

Hitachi DS18DA 260.00 \$
Akülü Darbelsiz Matkap
18 V, 2Ah,50 Nm, 0-350/0-1400 dev/dak, 13 mm çelik, 36 mm ahşap

Hitachi DV18DA 270.00 \$
Akülü Darbelsiz Matkap
18 V, 2Ah,50 Nm, 0-350/0-1400 dev/dak, 13 mm çelik, 36 mm ahşap



Hitachi G12SN2 107.00 \$
Avuç Taşlama
900 W, 125 mm disk çapı, M14x2 mil vidası, 10500 dev/dk,

Hitachi G12SR4 85.00 \$
Avuç Taşlama
730 W, 115 mm disk çapı, M14x2 mil vidası, 10000 dev/dk,

Hitachi G18ST 180.00 \$
Büyük Avuç Taşlama
2200 W, 180 mm disk çapı, M14x2 mil vidası, 85000 dev/dk,

Hitachi G23ST 180.00 \$
Büyük Avuç Taşlama
2200 W, 230 mm disk çapı, M14x2 mil vidası, 66000 dev/dk,



Hitachi Kırıcı Delici DH24PH 230.00 \$
730 W, 0-1050 dev/dk, 0-3950 dar/dak, 2.7 J darbe gücü, SDS Plus uç, 24 mm beton, 13 mm çelik, 32 mm ahşap delme kapasitesi,



Hitachi Kırıcı Delici DH40MC
1000 W, 0-620 dev/dk, 0-2880 dar/dak, 10.5 J darbe gücü, SDS Max uç, delme çapı 40 mm, max buat açma 105 mm



Hitachi Kırıcı Delici DH52MA
1500 W, 10-280 dev/dk, 1000-2400 dar/dak, 22 J darbe gücü, SDS Max uç, delme çapı 52 mm, max buat açma 160 mm



Hitachi Kırıcı Delici DH26PC2 260.00 \$
830 W, 0-1100 dev/dk, 0-4300 dar/dak, 3.2 J darbe gücü, SDS Plus uç, 3.6-26 mm beton, 32 mm ahşap, 13mm çelik delme



Hitachi Boya Karıştırıcı UM16VST 300.00 \$
1500 W, 160 mm, M14 vidası, 150/650 dev/dk,



Atlas Şaryo 500 kg	ATŞA05	66.00 \$
Atlas Şaryo 1000 kg	ATŞA01	103.00 \$
Atlas Şaryo 2000 kg	ATŞA02	125.00 \$
Atlas Şaryo 3000 kg	ATŞA03	175.00 \$
Atlas Şaryo 5000 kg	ATŞA5	225.00 \$



Atlas 3 MT Köşeli Caraskal 0.5 ton, 3 mt	ATCK053	89.00 \$
Atlas 3 MT Köşeli Caraskal 0.5 ton, 3 mt	ATCK055	110.00 \$
Atlas 3 MT Köşeli Caraskal 1 ton, 3 mt	ATCK13	97.00 \$
Atlas 5 MT Köşeli Caraskal 1 ton, 5 mt	ATCK15	120.00 \$
Atlas 3 MT Köşeli Caraskal 2 ton, 3 mt	ATCK23	137.00 \$
Atlas 5 MT Köşeli Caraskal 2 ton, 5 mt	ATCK25	163.00 \$
Atlas 3 MT Köşeli Caraskal 3 ton, 3 mt	ATCK33	175.00 \$
Atlas 5 MT Köşeli Caraskal 3 ton, 5 mt	ATCK35	231.00 \$
Atlas 3 MT Köşeli Caraskal 5 ton, 3 mt	ATCK53	260.00 \$
Atlas 5 MT Köşeli Caraskal 5 ton, 5 mt	ATCK55	325.00 \$



Atlas Hubzuglar 0.5 Ton, 5 mm zincir ölçüsü, 3.8 kg	ATH 0.5	93.00 \$
Atlas Hubzuglar 0.75 Ton, 6 mm zincir ölçüsü, 6.5 kg	ATH 0.7	122.00 \$
Atlas Hubzuglar 1.5 Ton, 8 mm zincir ölçüsü, 11.2 kg	ATH 1.5	150.00 \$
Atlas Hubzuglar 3 Ton, 10 mm zincir ölçüsü, 18.9 kg	ATH 3	215.00 \$
Atlas Hubzuglar 6 Ton, 10 mm zincir ölçüsü, 29.4 kg	ATH 6	325.00 \$
Atlas Hubzuglar 9 Ton, 10 mm zincir ölçüsü, 41.6 kg	ATH 9	525.00 \$



Atlas Trifor Takımları		
0.8 ton, 20 mt halat	ATT 0820	273.00 \$
1.6 ton, 20 mt halat	ATT 1620	380.00 \$
1.6 ton, 30 mt halat	ATT 1630	415.00 \$
3.2 ton, 20 mt halat	ATT 3220	610.00 \$
3.2 ton, 30 mt halat	ATT 3230	650.00 \$



Atlas Sac Kapmalar 1 Ton, 0-20 mm çene açıklığı	ATSK 1	77.00 \$
Atlas Sac Kapmalar 2 Ton, 0-25 mm çene açıklığı	ATSK 2	110.00 \$
Atlas Sac Kapmalar 3 Ton, 0-30 mm çene açıklığı	ATSK 3	158.00 \$
Atlas Sac Kapmalar 5 Ton, 0-50 mm çene açıklığı	ATSK 5	260.00 \$



Atlas Hidrolik Şişe Krikolar		
3 ton	ATŞK 3	22.00 \$
5 ton	ATŞK 5	26.00 \$
10 ton	ATŞK 10	34.00 \$
15 ton	ATŞK 15	47.00 \$
20 ton	ATŞK 20	62.00 \$
32 ton	ATŞK 32	88.00 \$
50 ton	ATŞK 50	200.00 \$
100 ton	ATŞK100	800.00 \$



Atlas Yuvarlak Caraskallar		
1 ton, 3 mt	ATCY 013	74.00 \$
1 ton, 5 mt	ATCY 015	90.00 \$
0,5 ton, 3 mt	ATCY 053	65.00 \$
0,5 ton, 5 mt	ATCY 055	82.00 \$
2 ton, 3 mt	ATCY 023	102.00 \$
2 ton, 5 mt	ATCY 025	133.00 \$
3 ton, 3 mt	ATCY 033	153.00 \$
3 ton, 5 mt	ATCY 035	200.00 \$



Bel Tipi Alet Çantası KLTCT11 208.35 TL
8 adet bölmeli, 1 kapaklı cep, su geçirmez kumaş



Küçük Boy Alet Çantası KLTCT14 666.70 TL
32x18x26 cm, su geçirmez kumaş

Orta Boy Alet Çantası KLTCT16 922.65 TL
36x22x31 cm, su geçirmez kumaş

Büyük Boy Alet Çantası KLTCT18 976.20 TL
48x25x35 cm, su geçirmez kumaş



Ağır Hizmet Tipi Sırt Çantası KLTCS28 940.50 TL
39x17x49 cm

Ağır Hizmet Tipi Tekerlekli Sırt Çantası KLTCS29-T 2023.80 TL
54x24x42 cm



Ağır Hizmet Tipi Alet Çantası KLTCT19-T 2291.70 TL
50.5x24x33 cm



Plastik Tabanlı Yarı Açık Taşıma Çantası KLTCT35-PT 1904.80 TL
40x21x25 cm



KLCS43-50 Civata Sabitleyici 92.00 TL
50 ml, Orta Mukavemet 236.00 TL
250 ml, Yüksek Mukavemet

KLCS70-50 Civata Sabitleyici 92.00 TL
50 ml, Yüksek Mukavemet 236.00 TL
250 ml, Yüksek Mukavemet

KLRS38-50 Rulman Sabitleyici 92.00 TL
50 ml, Yüksek Mukavemet 236.00 TL
250 ml, Yüksek Mukavemet

KLBS43-50 Boru Sızdırmazlık Elemanı 92.00 TL
50 ml 236.00 TL
250 ml



Fusion SF3 Plastik Boru Kaynak Makinesi Set 2797.65 TL

700 W, 220-240 V, 50 Hz, +50 / +320 C
Galvaniz kaplı mengene, ağır tip döküm ayak, 42 mm ağır tip hizmet makası, allen anahtar, pafta sökme çubuğu, 20-25-32-40 mm ağır hizmet tipi pafta, metal çanta

Fusion SF3 Plastik Boru Kaynak Makinesi Tek 1172.65 TL



Fusion Mini-S1 Plastik Boru Kaynak Makinesi Set 1904.80 TL

800 W, 220-240 V, 50 Hz, +50 / +320 C
Alüminyum ayak, 20-25-32 mm pafta, 42 mm otomatik makas (mavi), allen anahtarı, pafta sökme çubuğu, metal çanta

Fusion Mini Plastik Boru Kaynak Makinesi Tek 1130.95 TL



Fusion SF3-S6 Plastik Boru Kaynak Makinesi Set 2107.15 TL

700 W, 220-240 V, 50 Hz, +50 / +300 C, lazer kesim sac ayak, 20-25-32-40 mm ağır hizmet tipi pafta, 42 mm otomatik makas, allen anahtarı, pafta sökme çubuğu, metal çanta



CPM 158 80.- \$
Elektrikli Santrifuj Pompa
1100 W, 9 ton/saat, 230 volt

QB 60 41.50 \$
Elektrikli Su Pompası
330 Watt, 35 lt/dak, 230 volt, 5 kg



GS 24 187.- \$
Dal Öğütücü
2400 watt, 240 V, 50 Hz, 2900 min,
40 mm



BGE 520 Motorlu Tırpan 200.- \$
52 cc, 1.46 kw, 11 kg, sırt tipi



Motorlu Çit Budama 230.- \$
26 cc, 0.7 kw, 60 cm kesim
uzunluğu, 5.40 kg



Toprak Burgu Makinesi 260.- \$
52 cc, 1.46 kw, 8-20 cm burgü, 9.80
kg



GP 610 DP 103.- \$
Bahçe Pompası
1", 600 watt, 35 metre su basma
yüksekliği, 8 mm su çekme yüksekliği,
7 kg



Dalgıç Pompa Temiz Su 95.- \$
400 Watt, 230 V/50 Hz, 5500 lt/su,
azami yükseklik 6m, maks. derinlik 5m,
maks. basınç 0.6 bar, kablo uzunluğu
10m, hortum bağlantısı 1 1/2, su
sıcaklığı 35 C° ye kadar

Dalgıç Pompa Kirli Su 100.- \$
750 Watt, 230 V/50 Hz, 13500 lt/su,
azami yükseklik 8m, maks. derinlik 5m,
maks. basınç 0.7 bar, kablo uzunluğu
10m, hortum bağlantısı 1 1/2, su
sıcaklığı 35 C° ye kadar



4C - 60 Çay Kesme Toplama 455.- \$
26 cc, 0.7 kw, 525 mm kırpm boyu,
9.3 kg



Benzinli Su Motoru 3" 250.- \$
6.5 HP, 60m³/saat kapasite, 15
ton/saat - 24 metre kapasite dikey
arazide, 30 ton/saat - 250 metre yatay
arazi, 7m max su çekme yüksekliği,
24 kg

Benzinli Su Motoru 2" 225.- \$
5.5 HP, 30m³/saat kapasite, 5 ton/saat
- 28 metre kapasite dikey arazide, 25
ton/saat - 280 metre yatay arazi, 7m
max su çekme yüksekliği, 23 kg

Benzinli Su Motoru 1" 192.- \$
2.5 HP, 15m³/saat kapasite, 2 ton/saat
- 30 metre kapasite dikey arazide, 15
ton/saat - 200 metre yatay arazi, 7m
max su çekme yüksekliği, 5 kg



Portek Lazerli Sunta Kesme 66.- \$
800 W, 220V - 50 Hz, 4500 rpm,
185 mm



Portek Polisaj Makinası 62.- \$
180 mm



Portek 132.50 \$
Koyun Traşlama Makinası

240 volt, 400 watt, 2600 rpm, Sadece koyun, keçi, lama ve devegiller ailesinin diğer üyeleri üzerinde kullanılmak üzere tasarlanmıştır. Bunun yanında alet, standart olan kesici kafa değiştirilerek siğir, davar vb. büyükbaş hayvanların ve atların kırıpılmasında da kullanılabilir.

Koyun Traşlama Makinası
Yedek Bıçak 22.50 \$



Koyun Kırpm Makinası
240 watt MES 9876 132.50 \$



Şamandıralı Dalgıç Pompa 105.- \$



Kama Pala
36 Diş 11.- \$
38 Diş 11.- \$



**Dizel Marşlı İpli Jeneratör
AMC A5GF-ME**
6.5 kVA, 220 Volt

1313.- \$



**Benzinli İpli Marşlı Jeneratör
BT3800LE**
3.5 kVA, 220 Volt

477.90 \$



**Dizel Jeneratör
AMC LT12E**
15.5 kVA, 220 Volt

4301.10 \$



**Benzinli İpli Marşlı Jeneratör
BT8800LE**
7.5 kVA, 15 Hp, 220 Volt

1223.10 \$



**Dizel Jeneratör
AMC LT12E3**
15.5 kVA, 380 Volt

4480.10 \$



**Benzinli Motor
7.5 Hp, 4 Zamanlı**

161.90 \$



**Benzinli Su Motoru
BT50**
2"

209.- \$

**Benzinli Su Motoru
BT80**
3"

224.- \$



**Benzinli İpli Jeneratör
BT3800**
3.5 kVA, 220 Volt

429.30 \$



SDS - Max Beton Matkap Uçları

14 x 340 mm	MU0640	6.64 \$
16 x 340 mm	MU0650	7.10 \$
18 x 340 mm	MU0660	7.48 \$
20 x 340 mm	MU0670	7.95 \$
22 x 340 mm	MU0680	8.70 \$
24 x 340 mm	MU0690	9.70 \$
25.0 x 340 mm	15854	13.00 \$
26 x 340 mm	MU0700	12.80 \$
28 x 340 mm	MU0710	14.95 \$
32.0 x 370 mm	15883	23.00 \$
35.0 x 370 mm	15892	24.00 \$
38 x 370 mm	MU0801	30.80 \$
12.0 x 540 mm	15809	8.00 \$
14.0 x 540 mm	15815	9.00 \$
16 x 520 mm	MU0720	9.75 \$
18 x 520 mm	MU0730	10.20 \$
20 x 520 mm	MU0740	10.70 \$
22 x 520 mm	MU0750	11.50 \$
24 x 520 mm	MU0760	12.85 \$
26 x 520 mm	MU0770	16.80 \$
28 x 570 mm	MU0780	21.40 \$
30 x 570 mm	MU0790	23.00 \$
32 x 570 mm	MU0800	27.50 \$



SDS - Plus Beton Matkap Uçları

4 x 110 mm	MU0010	0.79 \$
5 x 110 mm	MU0020	0.79 \$
6 x 110 mm	MU0030	0.83 \$
7 x 110 mm	MU0040	0.85 \$
8 x 110 mm	MU0050	0.87 \$
9 x 110 mm	MU0060	0.89 \$
10 x 110 mm	MU0070	0.93 \$
5 x 160 mm	MU0090	0.83 \$
5.5 x 160 mm	MU0091	0.83 \$
6 x 160 mm	MU0100	0.84 \$
6.5 x 160 mm	MU0101	0.88 \$
7 x 160 mm	MU0110	0.94 \$
8 x 160 mm	MU0120	0.97 \$
9 x 160 mm	MU0130	1.02 \$
10 x 160 mm	MU0140	1.03 \$
11 x 160 mm	MU0150	1.07 \$
12 x 160 mm	MU0160	1.09 \$
13 x 160 mm	MU0170	1.38 \$
14 x 160 mm	MU0180	1.74 \$
15 x 160 mm	MU0190	1.77 \$
16 x 160 mm	MU0200	1.90 \$
5 x 210 mm	MU0210	0.98 \$
6 x 210 mm	MU0220	0.99 \$
6.5 x 210 mm	MU0230	1.11 \$
7 x 210 mm	MU0240	1.11 \$
8 x 210 mm	MU0250	1.11 \$
9 x 210 mm	MU0260	1.22 \$
10 x 210 mm	MU0270	1.22 \$
11 x 210 mm	MU0280	1.28 \$
12 x 210 mm	MU0290	1.30 \$
13 x 210 mm	MU0300	1.68 \$
14 x 210 mm	MU0310	1.92 \$
15 x 210 mm	MU0320	2.09 \$
16 x 210 mm	MU0330	2.23 \$
18 x 210 mm	MU0331	3.15 \$
19.0 x 200 mm		3.45 \$
6 x 260 mm	MU0340	1.22 \$
8 x 260 mm	MU0350	1.33 \$
10 x 260 mm	MU0360	1.43 \$
12 x 260 mm	MU0370	1.49 \$
14 x 260 mm	MU0380	2.28 \$
16 x 260 mm	MU0390	2.56 \$
18 x 260 mm	MU0400	3.42 \$
24.0 x 250 mm	15619	9.15 \$
6 x 310 mm	MU0401	1.53 \$
8 x 350 mm	MU0410	1.70 \$
10 x 350 mm	MU0420	1.85 \$
12 x 350 mm	MU0430	1.90 \$
14 x 350 mm	MU0440	2.69 \$
16 x 350 mm	MU0450	3.10 \$
18 x 350 mm	MU0460	4.10 \$
20 x 350 mm	MU0470	4.98 \$
22 x 350 mm	MU0480	5.60 \$
24 x 350 mm	MU0490	6.65 \$
10 x 450 mm	MU0500	2.46 \$
12 x 450 mm	MU0510	2.55 \$
14 x 450 mm	MU0520	3.48 \$
16 x 450 mm	MU0530	3.83 \$
18 x 450 mm	MU0540	4.87 \$
20 x 450 mm	MU0550	5.98 \$
22 x 450 mm	MU0560	6.90 \$
24 x 450 mm	MU0570	7.80 \$
26 x 450 mm	MU0580	9.95 \$
28 x 450 mm	MU0590	12.10 \$



SDS Max Keski

Yassı Keski 18x400x25 mm	MU0810	4.32 \$
Yassı Keski 18x500x25 mm	MU0820	5.47 \$
Yassı Keski 18x600x25 mm	MU0830	6.15 \$
Sivri Keski 18x400 mm	MU0840	4.32 \$
Sivri Keski 18x500 mm	MU0850	5.47 \$
Sivri Keski 18x600 mm	MU0860	6.15 \$
Geniş Yassı Keski 18x400x50 mm	MU0870	5.30 \$

SDS Plus Keski

Yassı Keski 14x250x22 mm	MU0600	1.75 \$
Sivri Keski 14x250 mm	MU0610	1.75 \$
Geniş Keski 14x250x40 mm	MU0620	2.30 \$
Oluk Keski 14x250 mm	MU0630	2.30 \$

SDS - Plus Buat Açma Adaptörü

250 mm	MU0886	5.16 \$
400 mm	MU0887	7.56 \$

SDS - Max Buat Açma Adaptörü

400 mm	MU0888	7.84 \$
--------	--------	---------

Beton Buat Açma

30 mm	MU0870-80	3.85 \$
35 mm	MU0870-81	4.00 \$
40 mm	MU0870-82	4.70 \$
45 mm	MU0870-83	5.26 \$
50 mm	MU0870-84	5.55 \$
55 mm	MU0870-85	6.18 \$
60 mm	MU0870-86	6.74 \$
65 mm	MU0870-87	7.35 \$
70 mm	MU0870-88	8.02 \$
75 mm	MU0870-89	8.65 \$
80 mm	MU0870-90	9.00 \$
100 mm	MU0870-91	13.72 \$
110 mm	MU0870-92	16.40 \$
120 mm	MU0870-93	18.64 \$
125 mm	MU0870-94	19.22 \$

SDS Beton Buat Açma Set

30 mm	MU0871	7.77 \$
35 mm	MU0872	7.86 \$
40 mm	MU0873	8.47 \$
45 mm	MU0874	8.74 \$
50 mm	MU0875	9.18 \$
55 mm	MU0876	9.58 \$
60 mm	MU0877	10.10 \$
65 mm	MU0878	10.50 \$
70 mm	MU0879	11.40 \$
75 mm	MU0880	12.45 \$
80 mm	MU0881	12.70 \$
100 mm	MU0882	18.38 \$
110 mm	MU0883	21.00 \$
120 mm	MU0884	24.00 \$
125 mm	MU0885	25.15 \$

16 Kg Kırıcılar için Keski

Yassı Keski 26x410x35 mm	MU0870-3	12.00 \$
Sivri Keski 26x410 mm	MU0870-2	12.00 \$



SDS - Max Beton Matkap Uçları

12.0 x 340 mm	2099	5.65 \$
14.0 x 340 mm	2100	5.67 \$
16.0 x 340 mm	2101	6.30 \$
16.0 x 540 mm	2102	9.50 \$
18.0 x 340 mm	2103	6.90 \$
18.0 x 540 mm	2104	9.80 \$
20.0 x 340 mm	2105	7.40 \$
20.0 x 520 mm	2106	10.10 \$
22.0 x 340 mm	2107	8.00 \$
22.0 x 520 mm	2108	11.10 \$
24.0 x 340 mm	2109	11.00 \$
24.0 x 520 mm	2110	14.30 \$
25.0 x 340 mm	2111	11.30 \$
25.0 x 520 mm	2112	14.80 \$
26.0 x 340 mm	2113	13.20 \$
26.0 x 520 mm	2114	17.50 \$
28.0 x 340 mm	2115	14.70 \$
28.0 x 570 mm	2116	20.00 \$
30.0 x 370 mm	2117	21.60 \$
32.0 x 570 mm	2118	28.00 \$
35.0 x 570 mm	2119	30.00 \$
38.0 x 570 mm	2120	37.00 \$
40.0 x 570 mm	2121	47.00 \$
42.0 x 570 mm	2122	55.00 \$
18.0 x 1000 mm	2123	20.00 \$
20.0 x 1000 mm	2124	21.00 \$
22.0 x 1000 mm	2125	23.50 \$
24.0 x 1000 mm	2126	27.00 \$
26.0 x 1000 mm	2127	32.50 \$
28.0 x 1000 mm	2128	38.00 \$
30.0 x 1000 mm	2129	45.00 \$
32.0 x 1000 mm	2130	52.00 \$
35.0 x 1000 mm	2131	61.00 \$
38.0 x 1000 mm	2132	70.00 \$
40.0 x 1000 mm	2133	90.00 \$

SDS - Max Beton Matkap Uçları

30.0 x 370 mm	15876	17.60 \$
---------------	-------	----------



4 Elmaslı

SDS - Plus Beton Matkap Uçları

5 x 160 mm	2075	1.03 \$
5 x 210 mm	2076	1.15 \$
6 x 160 mm	2077	1.03 \$
6 x 210 mm	2078	1.15 \$
6.5 x 210 mm	2079	1.15 \$
7 x 160 mm	2080	1.20 \$
7 x 210 mm	2081	1.38 \$
8 x 160 mm	2082	1.23 \$
8 x 210 mm	2083	1.38 \$
9 x 160 mm	2084	1.35 \$
9 x 210 mm	2085	1.58 \$
10 x 160 mm	2086	1.34 \$
10 x 210 mm	2087	1.55 \$
11 x 160 mm	2088	1.65 \$
11 x 210 mm	2089	1.82 \$
12 x 160 mm	2090	1.65 \$
12 x 210 mm	2091	1.83 \$
14 x 160 mm	2092	2.12 \$
14 x 210 mm	2093	2.30 \$
16 x 160 mm	2094	2.65 \$
16 x 210 mm	2095	2.87 \$
18 x 160 mm	2096	3.87 \$
20 x 210 mm	2097	4.75 \$



SDS - Max Murç ve Keski

Sivri Murç 18x400 mm	2153	4.00 \$
Sivri Murç 18x500 mm	2154	4.85 \$
Sivri Murç 18x600 mm	2155	5.60 \$
Yassı Keski 18x400 mm	2150	4.00 \$
Yassı Keski 18x500 mm	2151	4.85 \$
Yassı Keski 18x600 mm	2152	5.60 \$
Geniş Yassı Keski 18x50x300 mm	2156	4.25 \$
Geniş Yassı Keski 18x50x400 mm	2160	4.50 \$



Geniş Yassı	Oyma	Tarak	Yassı
Geniş Yassı Keski 80x300 mm	16006	5.60 \$	
Oyma Keski 26x300 mm	16007	5.60 \$	
Kanal Keski 32x300 mm	16008	5.60 \$	
Tarak Keski 32x300 mm	16009	5.60 \$	



29 AK Keski (Sedef PB50 kırıcı için)

Sivri Keski	16021	30.00 \$
Yassı Keski	16023	30.00 \$



29 AK Keski (PB45 kırıcı için)

26x410 mm Sivri Keski	2158	12.50 \$
26x410x35 mm Yassı Keski	2157	12.50 \$
907 Kanal Keski	16030	14.00 \$
908 Geniş Yassı Keski	16031	19.00 \$
909 Kürek Keski	16032	40.00 \$



SDS - Plus Beton Matkap Uçları

10.0 x 600 mm	2040	4.00 \$
12.0 x 600 mm	2041	4.15 \$
14.0 x 600 mm	2042	4.80 \$
16.0 x 600 mm	2043	5.90 \$
18.0 x 600 mm	2044	7.00 \$
20.0 x 600 mm	2045	8.95 \$
22.0 x 600 mm	2046	10.50 \$
24.0 x 600 mm	2047	12.80 \$
26.0 x 600 mm	2048	14.15 \$
28.0 x 600 mm	2049	16.00 \$
30.0 x 600 mm	2050	20.00 \$
10.0 x 800 mm	2051	5.75 \$
12.0 x 800 mm	2052	5.75 \$
14.0 x 800 mm	2053	6.50 \$
16.0 x 800 mm	2054	8.15 \$
18.0 x 800 mm	2055	9.60 \$
20.0 x 800 mm	2056	11.85 \$
22.0 x 800 mm	2057	13.30 \$
24.0 x 800 mm	2058	16.60 \$
26.0 x 800 mm	2059	18.40 \$
28.0 x 800 mm	2060	20.00 \$
30.0 x 800 mm	2061	25.00 \$
10.0 x 1000 mm	2062	7.50 \$
12.0 x 1000 mm	2063	7.70 \$
14.0 x 1000 mm	2064	8.30 \$
16.0 x 1000 mm	2065	10.40 \$
18.0 x 1000 mm	2066	12.50 \$
20.0 x 1000 mm	2067	15.00 \$
22.0 x 1000 mm	2068	17.00 \$
24.0 x 1000 mm	2069	21.90 \$
26.0 x 1000 mm	2070	24.00 \$
28.0 x 1000 mm	2071	26.00 \$
30.0 x 1000 mm	2072	30.00 \$

SDS - Plus Beton Matkap Uçları

25.0 x 250 mm	15624	11.00 \$
25.0 x 450 mm	15627	11.30 \$



SDS - Plus Beton Matkap Uçları

4.0 x 110 mm	1960	0.74 \$
4.0 x 160 mm	1961	0.80 \$
5.0 x 110 mm	1962	0.74 \$
5.0 x 160 mm	1963	0.80 \$
5.0 x 210 mm	1964	0.99 \$
5.5 x 160 mm	1966	0.80 \$
5.5 x 210 mm	1967	1.03 \$
6.0 x 110 mm	1968	0.74 \$
6.0 x 160 mm	1969	0.80 \$
6.0 x 210 mm	1970	1.01 \$
6.0 x 260 mm	1971	1.12 \$
6.0 x 310 mm	1972	1.47 \$
6.5 x 160 mm	1973	0.84 \$
6.5 x 210 mm	1974	1.04 \$
6.5 x 260 mm	1975	1.17 \$
7.0 x 110 mm	1976	0.79 \$
7.0 x 160 mm	1977	0.91 \$
7.0 x 210 mm	1978	1.08 \$
7.0 x 260 mm	1979	1.30 \$
8.0 x 110 mm	1980	0.80 \$
8.0 x 160 mm	1981	0.93 \$
8.0 x 210 mm	1982	1.11 \$
8.0 x 260 mm	1983	1.30 \$
8.0 x 350 mm	1984	1.80 \$
8.0 x 450 mm	1985	2.60 \$
9.0 x 110 mm	1986	0.91 \$
9.0 x 160 mm	1987	0.97 \$
9.0 x 210 mm	1988	1.18 \$
10.0 x 110 mm	1989	0.93 \$
10.0 x 160 mm	1990	1.01 \$
10.0 x 210 mm	1991	1.20 \$
10.0 x 260 mm	1992	1.41 \$
10.0 x 310 mm	1993	1.66 \$
10.0 x 350 mm	1994	1.89 \$
10.0 x 450 mm	1995	2.50 \$
11.0 x 160 mm	1997	1.04 \$
11.0 x 210 mm	1998	1.30 \$
12.0 x 160 mm	2000	1.13 \$
12.0 x 210 mm	2001	1.38 \$
12.0 x 260 mm	2002	1.60 \$
12.0 x 310 mm	2003	1.88 \$
12.0 x 350 mm	2004	2.04 \$
12.0 x 450 mm	2005	2.85 \$
13.0 x 160 mm	2006	1.47 \$
13.0 x 210 mm	2007	1.79 \$
14.0 x 160 mm	2008	1.53 \$
14.0 x 210 mm	2009	1.84 \$
14.0 x 260 mm	2010	2.24 \$
14.0 x 310 mm	2011	2.30 \$
14.0 x 350 mm	2012	2.52 \$
14.0 x 450 mm	2013	3.13 \$
15.0 x 160 mm	2014	1.98 \$
15.0 x 210 mm	2015	2.21 \$
16.0 x 160 mm	2016	1.98 \$
16.0 x 210 mm	2017	2.22 \$
16.0 x 260 mm	2018	2.50 \$
16.0 x 310 mm	2019	2.89 \$
16.0 x 350 mm	2020	3.10 \$
16.0 x 450 mm	2021	3.86 \$
17.0 x 210 mm	2021-1	2.90 \$
18.0 x 210 mm	2022	3.00 \$
18.0 x 260 mm	2023	3.30 \$
18.0 x 310 mm	2024	3.69 \$
18.0 x 350 mm	2025	4.05 \$
18.0 x 450 mm	2026	4.90 \$
20.0 x 210 mm	2027	3.74 \$
20.0 x 260 mm	2028	4.50 \$
20.0 x 310 mm	2029	4.65 \$
20.0 x 350 mm	2030	5.10 \$
20.0 x 450 mm	2031	6.30 \$
22.0 x 350 mm	2032	6.05 \$
22.0 x 450 mm	2033	7.10 \$
24.0 x 350 mm	2034	7.35 \$
24.0 x 450 mm	2035	9.00 \$
26.0 x 450 mm	2036	10.50 \$
28.0 x 450 mm	2037	12.40 \$



- Tarak
- Kanal
- Geniş Yassı
- Sivri

SDS - Plus Keski

Sivri Murç Keski 14x250 mm	2148	1.60 \$
Yassı Keski 14x250 mm	2147	1.60 \$
Geniş Yassı Keski 14x40x250mm	2146	2.08 \$
Kanal Keski 250 mm	2145	2.08 \$
Tarak Keski 250 mm	15715	2.08 \$

SDS - Plus Keski

Sivri Murç Keski 14x250 mm	MES 591	1.85 \$
Yassı Keski 14x250 mm	MES 590	1.85 \$



M42 - Bimetal Delik Testereleer

16 mm	4800	1.87 \$
17 mm	4801	1.95 \$
19 mm	4802	2.10 \$
20 mm	4803	2.20 \$
22 mm	4804	2.40 \$
25 mm	4805	2.75 \$
28 mm	4806	3.05 \$
30 mm	4807	3.30 \$
32 mm	4808	3.50 \$
35 mm	4809	3.85 \$
38 mm	4810	3.95 \$
40 mm	4811	4.10 \$
41 mm	4812	4.25 \$
44 mm	4813	4.50 \$
46 mm	4814	4.70 \$
48 mm	4815	4.90 \$
51 mm	4816	5.20 \$
54 mm	4817	5.45 \$
57 mm	4818	5.70 \$
60 mm	4819	6.15 \$
63 mm	4820	6.60 \$
64 mm	4820-1	6.75 \$
65 mm	4821	6.95 \$
68 mm	4822	7.15 \$
70 mm	4823	7.30 \$
73 mm	4824	7.55 \$
76 mm	4825	7.80 \$
79 mm	4826	8.20 \$
83 mm	4827	8.50 \$
86 mm	4828	8.90 \$
89 mm	4829	9.15 \$
92 mm	4830	9.50 \$
95 mm	4831	9.75 \$
98 mm	4832	10.00 \$
102 mm	4833	10.30 \$
105 mm	4834	10.70 \$
108 mm	4835	11.00 \$
111 mm	4836	11.55 \$
114 mm	4837	11.80 \$
121 mm	4838	12.35 \$
127 mm	4839	12.95 \$
133 mm	4840	13.60 \$
140 mm	4841	14.35 \$
146 mm	4842	15.00 \$
152 mm	4843	15.60 \$
160 mm	4844	16.60 \$
168 mm	4845	17.20 \$
178 mm	4846	18.50 \$
200 mm	4847	21.00 \$
210 mm	4848	24.15 \$



Bimetal 21935 Delik Testere Seti
19-22-25-32-35-38-44-51-57-64-76 mm, 9001-9002 merkezleyici

Elmas Kaplı 21889 33.00 \$ Delik Testere Seti
33-53-67-73-83 mm, merkezleyici, elmas eęe



TCT Elmas Uç Metal Delme Pañç

16 mm	MU0888-02	2.76 \$
18 mm	MU0888-03	3.08 \$
19 mm	MU0888-04	3.25 \$
20 mm	MU0888-05	3.43 \$
22 mm	MU0888-06	3.75 \$
25 mm	MU0888-07	4.24 \$
28 mm	MU0888-08	4.17 \$
30 mm	MU0888-09	5.12 \$
32 mm	MU0888-10	5.44 \$
35 mm	MU0888-11	5.93 \$
38 mm	MU0888-12	6.46 \$
40 mm	MU0888-13	6.85 \$
44 mm	MU0888-14	7.52 \$
48 mm	MU0888-15	8.19 \$
50 mm	MU0888-16	8.54 \$
54 mm	MU0888-17	9.18 \$
60 mm	MU0888-18	10.24 \$
65 mm	MU0888-19	10.42 \$
70 mm	MU0888-20	11.20 \$
75 mm	MU0888-21	13.40 \$
80 mm	MU0888-22	15.95 \$
85 mm	MU0888-23	16.90 \$
90 mm	MU0888-24	17.97 \$
95 mm	MU0888-25	20.30 \$
100 mm	MU0888-26	28.80 \$
110 mm	MU0888-27	30.00 \$
120 mm	MU0888-28	32.35 \$

9001 Merkezleyici 2.15 \$
14-29 mm için, altıköşe sap
4860

9002 Merkezleyici 4861 4.95 \$
30-210 mm için, altıköşe sap

SDS Plus Merkezleyici
14 - 29 mm 4862 2.30 \$
30 - 210 mm 4863 5.00 \$

Bimetal Pañç Adaptörü HEX
14-29 mm MK0364 1.55 \$
30-210 mm MK0365 3.35 \$

Bimetal Pañç Adaptörü SDS
14-29 mm MK0366 2.05 \$
30-210 mm MK0367 3.55 \$

Elmas Kaplı Delik Testereleer
33 mm 21891 47.30 TL
53 mm 21892 73.10 TL
67 mm 21893 86.00 TL
73 mm 21894 94.60 TL
83 mm 21895 120.85 TL
Elmas Uçlu Merkezleyici
21890 40.85 TL



T 111 C MK2312 1.15 \$
HCS, 100 mm,8 diş, ahşap, 5'li set,
4-50mm kesim alanı

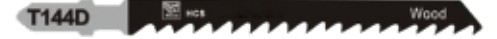

T 144 D MK2311 1.30 \$
HCS, 100 mm,6 diş, ahşap, 5'li set,
4-50mm kesim alanı



T 101 D MK2313 1.75 \$
HCS, 100 mm,6 diş, ahşap, 5'li set,
4-50mm kesim alanı

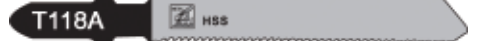

T 118 A MK2314 3.25 \$
HSS, 76 mm,24 diş, metal, 5'li set,
1-3mm kesim alanı



T 318 A GFB2251 6.25 \$
HSS, 117 mm,6 diş, ahşap, 5'li set,
4-67mm kesim alanı



T 344 53415 2.85 \$
HSS, 152 mm,6 diş, ahşap, 5'li set,
4-101mm kesim alanı



M 5044 53464 1.60 \$
HCS, 86 mm,8 diş, ahşap, 5'li set,
4-45mm kesim alanı



M 5042 53462 1.60 \$
HCS, 86 mm,6 diş, ahşap, 5'li set,
4-45mm kesim alanı



M 5039 53454 3.85 \$
HSS, 77 mm,24 diş, metal, 5'li set,
1-3mm kesim alanı



S 1211 K MK2317-1 11.40 \$
Kemik Tilki Kuyruęu Paslanmaz
Paslanmaz, 225 mm, Adet fiyatıdır.



S 1531-L Tilki Kuyruęu 8.35 \$
HCS, ağaç, 5'li set, MK2315



S 1122 HF MK2317 10.80 \$
Ağaç Metal Tilki Kuyruęu
HCS, 300 mm, 5'li set,

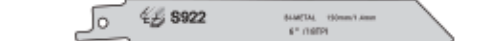

S 922-EF Metal Tilki Kuyruęu 7.85 \$
HSS, 150 mm MK2316 5'li set,



S 1243 HM Yutong Tuęla Kesme Tilki Kuyruęu
HCS, 305 mm MK2318 12.50 \$
HCS, 455 mm MK2319 24.00 \$



Ahşap Havşa Matkaplara Havşa Kafası

3 mm	16350 / MU1805	2.10 \$
4 mm	16351 / MU1806	2.10 \$
5 mm	16352 / MU1807	2.10 \$
6 mm	16353	2.10 \$



Elmaslı Havşa Matkaplara Havşa Kafası

3 mm	53270	2.00 \$
3.5 mm	53271	2.00 \$
4 mm	53272	2.00 \$
5 mm	53273	3.00 \$
6 mm	53274	3.00 \$
7 mm	53275	3.00 \$



Ayarlı Delme Panç Seti

200 mm	MK0312	6.50 \$
300 mm	MK0314	8.20 \$



Elektrikli Rende Bıçağı

Black Decker 82 mm, elmas	53511	2.80 \$ / Çift
Bosch 75 mm, elmas	53512	2.80 \$ / Çift



Elektrikli Planya Bıçağı

SEDEF PK82 ve Makita 1900B planyalar içindir.	53515	4.50 \$
---	-------	---------



Siyah Beyaz Matkap Ucu Seti

1 - 10 mm - 19 Parça	1560	14.00 \$
1 - 13 mm - 25 Parça	1561	29.00 \$

Taşlanmış Matkap Ucu Seti

1 - 10 mm - 19 Parça	1562	33.00 \$
1 - 13 mm - 25 Parça	1563	70.00 \$



16'lı Matkap Ucu Seti

(4, 5, 6, 8, 10 mm ahşap uç)	MU1804	10.50 \$
(3, 4, 5, 6, 8 mm metal uç)		
(4x75, 5x85, 6x100, 8x120, 10x120 mm beton uç)		

CV Ahşap Matkap Uçları

3.0 x 60 mm	16053	0.16 \$
4.0 x 75 mm	16054	0.18 \$
5.0 x 85 mm	16055	0.22 \$
6.0 x 90 mm	16056	0.26 \$
7.0 x 110 mm	16057	0.29 \$
8.0 x 120 mm	16058	0.33 \$
10.0 x 120 mm	16060	0.45 \$
12.0 x 140 mm	16062	0.60 \$
14.0 x 150 mm	16064	1.00 \$
15.0 x 160 mm	16065	1.20 \$
16.0 x 160 mm	16066	1.49 \$
18.0 x 170 mm	16068	2.47 \$
20.0 x 180 mm	16070	3.03 \$



Ahşap Kiriş Matkap Uçları

8 x 250 mm	MU1580	1.63 \$
10 x 250 mm	MU1590	1.75 \$
12 x 250 mm	MU1600	1.91 \$
14 x 250 mm	MU1610	2.36 \$
16 x 250 mm	MU1620	2.80 \$
18 x 250 mm	MU1630	3.31 \$
20 x 250 mm	MU1640	4.11 \$
22 x 250 mm	MU1650	4.75 \$
24 x 250 mm	MU1660	5.64 \$

8 x 500 mm	MU1670	2.80 \$
10 x 500 mm	MU1680	2.90 \$
12 x 500 mm	MU1690	3.05 \$
14 x 500 mm	MU1700	4.25 \$
16 x 500 mm	MU1710	4.75 \$
18 x 500 mm	MU1720	5.55 \$
20 x 500 mm	MU1730	6.83 \$
22 x 500 mm	MU1740	8.54 \$
24 x 500 mm	MU1750	10.40 \$



Ahşap Kalıpcı Matkap Uçları SDS Saplı

10 x 60 mm	MU1751	4.90 \$
12 x 600 mm	MU1752	5.35 \$
14 x 600 mm	MU1753	5.87 \$
16 x 600 mm	MU1754	6.21 \$
18 x 600 mm	MU1755	6.54 \$
20 x 600 mm	MU1756	7.15 \$
22 x 600 mm	MU1757	8.15 \$
24 x 600 mm	MU1758	10.00 \$



Beton Matkap Ucu Seti

5'li beton uç (4, 5, 6, 8, 9, 10 mm)	53801	4.00 \$
---	-------	---------

Elmas Ucu Seti

7'li elmas uç (4, 5, 6, 8, 9, 10 mm)	MU1801	5.10 \$
---	--------	---------

HSS Matkap Ucu Seti

13'lü HSS uç (1.5, 2, 2.5, 3, 3.5, 4, 4.5, 5, 5.5, 6, 6.5 mm)	MU1802	4.05 \$
--	--------	---------

Ahşap Matkap Ucu Seti

8'li ahşap uç (3, 4, 5, 6, 7, 8, 9, 10 mm)	MU1803	4.22 \$
---	--------	---------



Yaprak Matkap Uçları

12 mm	MU1578-85	0.97 \$
14 mm	MU1578-86	1.00 \$
16 mm	MU1578-87	1.03 \$
18 mm	MU1578-88	1.06 \$
20 mm	MU1578-89	1.09 \$
22 mm	MU1578-90	1.13 \$
24 mm	MU1578-91	1.15 \$
26 mm	MU1578-92	1.20 \$

Yaprak Matkap Ucu Takımı

6 parça	MU1579	5.00 \$
---------	--------	---------



Kırlangıç Kanal Açma Bıçakları

V Kanal 8 mm sap	53320	3.40 \$
V Kanal 6 mm sap	53322	3.40 \$
T Kanal 8 mm sap	53326	3.40 \$
T Kanal 6 mm sap	53327	3.40 \$



Menteşe Yeri Açma Ucu

26 mm	MU1811	1.89 \$
35 mm	MU1812	2.51 \$
40 mm	MU1813	2.91 \$
35 mm SAĞ	53256	2.92 \$
35 mm SOL	53266	2.92 \$



Ahşap Delik Destereler

Küçük Boy Delik Destere - Çin	15.00 TL
25-32-39-46-52-59-65 mm	
Orta Boy Delik Destere - Çin	57.00 TL
68-75-82-95 mm	

Buat Açma Seti

8 Parça	MK0290	6.10 \$
64-76-89-102-127 mm		
11 Parça	MK0300	4.90 \$
19-25-28-32-38-44-51-64 mm		
16 Parça	MK0310	9.10 \$
19-22-28-32-38-44-51-64-76-89-102-127 mm		

Buat Açma Seti

8 Parça	MES 513	8.00 \$
11 Parça	MES 514	6.40 \$
16 Parça	MES 515	11.50 \$



Bimetal Testere Seti

9 Parça	MES 1454	47.80 \$
19-22-29-38-44-57 mm		

Bimetal Testere Seti

13 Parça	MES 1455	70.65 \$
19-22-29-35-38-44-51-57-64 mm		



d = 8 mm d = 12 mm



11 parça ahşap motif bıçağı 53349 61.- \$
8 mm sap, 53011-53021-53031-53050-53070-53130
53140 -53160-53170-53222-53244



d = 8 mm d = 12 mm



18 parça ahşap motif bıçağı 53354 90.- \$
8 mm sap, 53011-53020-53021-53022-53031-53040-
53050-53070-53110-53130-53140-53160-53170-
53200 - 53222-53243-53244-53245



CNC Makina Delici Uçlar - Sağ

5 mm 70 (35) mm boy	52422	6.20 \$
6 mm 70 (35) mm boy	52423	6.20 \$
7 mm 70 (35) mm boy	52424	6.20 \$
8 mm 70 (35) mm boy	52425	6.20 \$
10 mm 70 (35) mm boy	52427	6.20 \$
12 mm 70 (35) mm boy	52429	7.74 \$
15 mm 70 (35) mm boy	52432	10.80 \$
16 mm 70 (35) mm boy	52433	10.80 \$



CNC Makina Delici Uçlar - Sol

5 mm 70 (35) mm boy	52402	6.20 \$
6 mm 70 (35) mm boy	52403	6.20 \$
7 mm 70 (35) mm boy	52404	6.20 \$
8 mm 70 (35) mm boy	52405	6.20 \$
10 mm 70 (35) mm boy	52407	6.20 \$
12 mm 70 (35) mm boy	52409	7.74 \$
15 mm 70 (35) mm boy	52412	10.80 \$
16 mm 70 (35) mm boy	52413	10.80 \$



CNC Makina Sivri Delici Uçlar - Sağ

5 mm 70 (35) mm boy	52462	6.20 \$
6 mm 70 (35) mm boy	52463	6.20 \$
7 mm 70 (35) mm boy	52464	6.20 \$
8 mm 70 (35) mm boy	52465	6.20 \$
10 mm 70 (35) mm boy	52467	6.20 \$
12 mm 70 (35) mm boy	52469	7.74 \$
15 mm 70 (35) mm boy	52472	10.80 \$
16 mm 70 (35) mm boy	52473	10.80 \$



CNC Makina Sivri Delici Uçlar - Sol

5 mm 70 (35) mm boy	52442	6.20 \$
6 mm 70 (35) mm boy	52443	6.20 \$
7 mm 70 (35) mm boy	52444	6.20 \$
8 mm 70 (35) mm boy	52445	6.20 \$
10 mm 70 (35) mm boy	52447	6.20 \$
12 mm 70 (35) mm boy	52449	7.74 \$
15 mm 70 (35) mm boy	52452	10.80 \$
16 mm 70 (35) mm boy	52453	10.80 \$

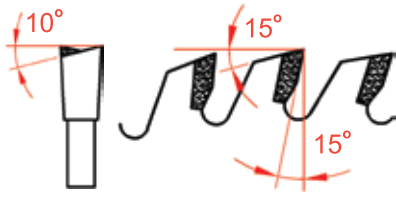

Elmas Daire Testereler

Alternatif diş, ahşap malzemeler için,
Elektrikli el aletlerinde kullanılmak üzere

115x22-16x2.2x2 mm 24 diş	53661	4.60 \$
150x20-16x2.2x2 mm 24 diş	53664	8.65 \$
180x20-16x2.2x2 mm 24 diş	53667	8.80 \$
180x20-16x2.2x2 mm 48 diş		10.75 \$
190x30-16x2.2x2 mm 30 diş		15.60 \$
210x30-25-20x2.2x2 mm 24 diş	53670	18.97 \$
235x30-25-20x2.2x2 mm 24 diş	53673	21.00 \$

Elmas Daire Testereler

230 x 30 mm - 40 diş	2375	10.00 \$
300 x 30 mm - 40 diş	2376	19.00 \$



Sunta Elmas Daire Testereler

115 x 22 mm - 36 diş	MK0285	2.50 \$
180 x 22 mm - 30 diş	MK0286	4.30 \$
180 x 30 mm - 40 diş	MK0286-1	4.50 \$
185 x 30 mm - 40 diş	MK0286-2	4.70 \$
190 x 30 mm - 40 diş	MK0286-3	4.90 \$



Ahşap ve Sunta Kesici Testereler

115 x 22 mm - 40 diş	MES 581	3.20 \$
180 x 22 mm - 30 diş	MES 583	5.60 \$
210 x 30 mm - 40 diş	MES 586	7.80 \$

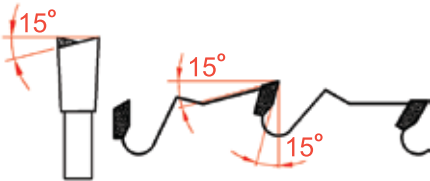

Alternatif diş, atlamalı

250x30-25-20x3.2x2.2 mm 24 diş	53621	19.90 \$
300x30-25-20x3.2x2.4 mm 28 diş	53642	23.25 \$

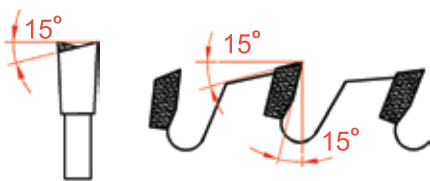

Alternatif diş,

250x30-25-20x3.2x2.2 mm 48 diş	53623	26.20 \$
250x30-25-20x3.2x2.2 mm 60 diş	53625	27.90 \$
300x30-25-20x3.2x2.4 mm 48 diş	53643	30.40 \$
300x30-25-20x3.2x2.4 mm 60 diş	53645	32.55 \$

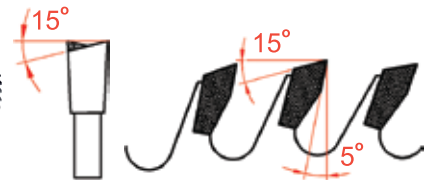

Alternatif sık diş

250x30-25-20x3.2x2.4 mm 80 diş	53627	46.00 \$
300x30-25-20x3.2x2.8 mm 80 diş	53646	51.15 \$
300x30-25-20x3.2x2.8 mm 96 diş	53651	80.00 \$

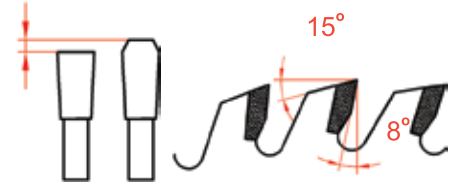

Trapez pozitif diş

180x20-16x2.2x2 mm 60 diş	53680	15.33 \$
---------------------------	-------	----------

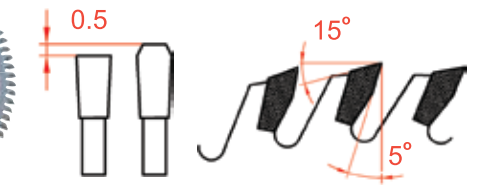

Trapez pozitif diş

200x30-25-20x2.8x2.8 mm 64 diş	53684	30.00 \$
200x30-25-20x2.8x2.4 mm 80 diş	53685	33.00 \$

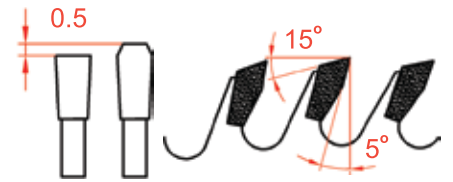

Trapez pozitif diş

250x30-25-20x3.2x2.4 mm 80 diş	53688	83.00 \$
300x30-25-20x3.2x2.8 mm 96 diş	53690	99.00 \$

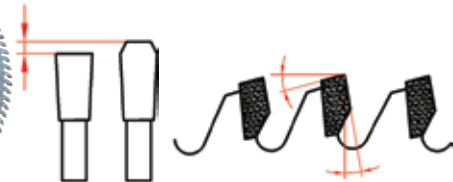

Trapez, negatif diş

Aluminyum, plastik için

350x32-30-25x3.5x2.5 mm 108 diş	53692	157.00 \$
400x32-30-25x3.5x3 mm 120 diş	53697	130.50 \$
420x32-30-25x3.5x3 mm 108 diş	53701	130.00 \$
450x32-30-25x3.5x3 mm 120 diş	53702	152.10 \$

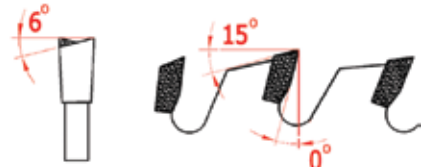

Çizici Testere

125x20 mm 24 diş	53551	47.- \$
------------------	-------	---------



Kesilebilecek Malzeme Ölçüleri
Doğu Malzeme: 15 mm
Profil: 25x25 mm
Boru: 1.5"
Köşebent: 25x25 mm
Lama: 25x5 mm

Ağaç Kesen Daire Testere

250 x 30 mm, 76 diş	53750	19.80 \$
300 x 30 mm, 76 diş	53751	25.85 \$
350 x 30 mm, 76 diş	53752	33.55 \$
400 x 30 mm, 76 diş	53753	39.65 \$
450 x 30 mm, 76 diş	53754	59.50 \$
500 x 30 mm, 56 diş	53755	83.95 \$
600 x 30 mm, 56 diş	53756	91.55 \$
700 x 40 mm, 56 diş	53757	132.80 \$
800 x 40 mm, 56 diş	53758	169.40 \$

MPC 35 Profil Kesme Makinası 12123 595- \$
3 HP, 230 Volt, 350x2.5x32 mm testere,
65x50x72 mm taş dahil, 50 kg



Kesilebilecek Malzeme Ölçüleri
Doğu Malzeme: 20 mm
Profil: 30 mm
Boru: 2"
Köşebent: 40x40 mm
Lama: 40x10 mm

PCM 42 Profil Kesme Makinası 12124 702.- \$
4 HP, 380 Volt, 420x4x40 mm testere,
200x20x20 mm taş dahil, 85 kg

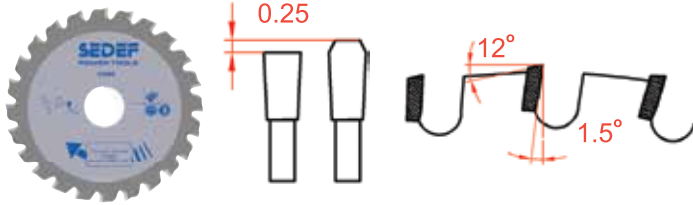

Metal Kesici Süper Testere

115x22x2.2x2.4 mm, 24 diş	53580	21.80 \$
180x22x2.2x2.4 mm, 36 diş	53581	36.30 \$
230x22x2.2x2.4 mm, 48 diş	53582	31.50 \$
185x20-16x2.2x2.4 mm, 36 diş	53586	31.50 \$
350x25.4x2.4x2.4mm, 72 diş	53589	74.40 \$



Kesilebilecek Malzeme Ölçüleri
Doğu Malzeme: 35 mm
Profil: 140 mm
Boru: 4"
Köşebent: 100x100 mm
Lama: 150x15 mm

PCM 52 Profil Kesme Makinası 12127 1250.- \$
10 HP, 380 Volt, 520x4x40 mm testere,
200x20x20 mm taş dahil, 190 kg



Zincir Daire Testere

Ağaç kesmek için taşlama aletlerine takılarak kullanılır.

180 mm 8500 min - 1	52050	9.50 \$
Zincirli Ağşap Testere		
115x22 mm	929	5.05 \$



Metal Profil Kesme Testeresi

520 x 4 x 40 mm	53727	73.00 \$
400 x 3 x 40 mm	53725	55.00 \$
350 x 2.5 x 32 mm	53724	45.00 \$
620 x 4.0 x 40 mm	53734	112.00 \$

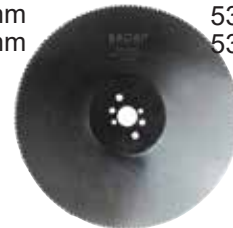

Zincir Ağşap Testere

115 mm	MK0286-10	7.00 \$
125 mm	MK0286-11	7.30 \$
180 mm	MK0286-12	16.50 \$

M35-HSS- CO5 Daire Testere

200x1.8x32 mm, 160 diş	61701	63.50 Euro
225x2.0x32 mm, 180 diş	61706	77.50 Euro
250x2.0x32 mm, 200 diş	61711	80.50 Euro
275x2.5x32 mm, 220 diş	61716	116.00 Euro
300x2.5x32 mm, 220 diş	61721	145.00 Euro



Seramik Mermer Panç

6 mm	MK0289-50	10.20 \$
8 mm	MK0289-51	10.20 \$
10 mm	MK0289-52	10.20 \$
12 mm	MK0289-53	10.20 \$
14 mm	MK0289-54	10.20 \$
16 mm	MK0287	11.10 \$
18 mm	MK0288	11.70 \$
20 mm	MK0289	12.20 \$
22 mm	MK0289-2	13.70 \$
25 mm	MK0289-4	15.50 \$
30 mm	MK0289-10	19.40 \$
33 mm	MK0289-13	20.60 \$
35 mm	MK0289-15	21.90 \$
40 mm	MK0289-20	26.40 \$
45 mm	MK0289-25	30.00 \$
50 mm	MK0289-30	33.00 \$
55 mm	MK0289-35	36.00 \$
60 mm	MK0289-40	39.50 \$
65 mm	MK0289-45	41.30 \$



Mermer Granit Panç M14

12 mm	4885	8.40 \$
16 mm	4886	10.70 \$
18 mm	4887	11.90 \$
20 mm	4888	13.00 \$
22 mm	4889	14.50 \$
25 mm	4890	15.90 \$
33 mm	4891	20.00 \$
34 mm	4892	21.00 \$



Vakumlu Mermer Granit Delme Panç

12 mm	4870	10.60 \$
14 mm	4871	10.80 \$
16 mm	4872	11.00 \$
18 mm	4873	12.50 \$
20 mm	4874	14.00 \$
22 mm	4875	15.50 \$
25 mm	4876	17.00 \$
28 mm	4877	20.00 \$
33 mm	4878	23.00 \$
35 mm	4879	23.30 \$
38 mm	4880	29.00 \$
45 mm	4881	33.20 \$
52 mm	4882	39.50 \$
57 mm	4883	42.00 \$
63 mm	4884	48.00 \$



Mermer Granit Delme Panç Hex Bağlantı

12 mm	4893	8.20 \$
18 mm	4894	11.70 \$
20 mm	4895	12.80 \$



TCT Elmas Uç Metal Delme Panç

16 mm	4700	2.55 \$
18 mm	4701	2.75 \$
19 mm	4702	3.00 \$
20 mm	4703	3.10 \$
22 mm	4704	3.37 \$
25 mm	4705	3.70 \$
28 mm	4706	4.20 \$
30 mm	4707	4.55 \$
32 mm	4708	4.70 \$
35 mm	4709	5.25 \$
38 mm	4710	5.90 \$
40 mm	4711	6.20 \$
44 mm	4712	6.75 \$
48 mm	4713	7.45 \$
50 mm	4714	7.55 \$
54 mm	4715	8.35 \$
60 mm	4716	8.95 \$
65 mm	4717	9.75 \$
70 mm	4718	10.60 \$
75 mm	4719	12.57 \$
80 mm	4720	14.25 \$
85 mm	4721	15.85 \$
90 mm	4722	16.65 \$
95 mm	4723	18.95 \$
100 mm	4724	28.75 \$
110 mm	4725	29.40 \$
120 mm	4726	31.55 \$



SDS Beton Buat Açma

30 mm	2200	6.30 \$
35 mm	2201	6.70 \$
40 mm	2202	7.20 \$
45 mm	2203	7.30 \$
50 mm	2204	7.60 \$
55 mm	2205	7.90 \$
60 mm	2206	8.35 \$
65 mm	2207	8.70 \$
70 mm	2208	9.40 \$
75 mm	2209	10.20 \$
80 mm	2210	11.00 \$
100 mm	2211	18.00 \$
110 mm	2212	20.00 \$
120 mm	2213	24.00 \$
125 mm	2214	28.00 \$



Cam ve Seramik Matkap Ucu

4 mm	4600	1.50 \$
5 mm	4601	1.50 \$
6 mm	4602	1.50 \$
7 mm	4603	1.90 \$
8 mm	4604	2.00 \$
9 mm	4605	2.45 \$
10 mm	4606	2.80 \$
12 mm	4607	3.40 \$
14 mm	4608	4.40 \$

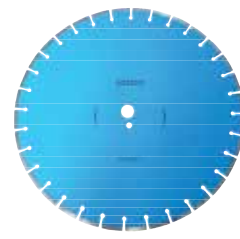

Segmentli Elmas Beton Testereleri

300 mm	51915	5 475.- TL
350 mm	51916	6 385.- TL
400 mm	51917	7 290.- TL
450 mm	51918	8 205.- TL
500 mm	51935	10 935.- TL
600 mm	51920	18 225.- TL
700 mm	51925	22 800.- TL
800 mm	51926	24 610.- TL
830 mm	51927	31 890.- TL
900 mm	51928	36 450.- TL
1000 mm	51929	45 570.- TL
1200 mm	51930	54 690.- TL

Soketli Elmas Beton Testere

115 x 22.23 mm	MK0264	2.55 \$
180 x 22.23 mm	MK0265	5.00 \$
230 x 22.23 mm	51953	8.00 \$

Soketli Elmas Beton Testere

230 x 22.23 mm	2390	8.00 \$
----------------	------	---------

Turbo Elmas Beton Testere

115 x 2.2 x 22.2 mm, sürekli elmas	51941 / MK0270	2.60 \$
180 x 2.4 x 22.2 mm, sürekli elmas	51942 / MK0280	5.00 \$
230 x 2.6 x 22.2 mm, sürekli elmas	51943	8.35 \$

Turbo Elmas Beton Testere

115 x 2.2 x 22.2 mm, sürekli elmas	MES 578	3.00 \$
------------------------------------	---------	---------

Turbo Elmas Beton Testere

230 x 2.6 x 22.2 mm, sürekli elmas	2387	8.35 \$
------------------------------------	------	---------



Sürekli Form Elmas Beton Testereleri

300x3x25,4 mm	51975	90.- \$
350x3,2x25,4 mm	51976	105.- \$
400x4x25,4 mm	51977	133.- \$



Cam ve Seramik Matkap Ucu

4 mm	MU1820	1.25 \$
5 mm	MU1821	1.25 \$
6 mm	MU1822	1.25 \$
7 mm	MU1823	1.45 \$
8 mm	MU1824	1.70 \$
9 mm	MU1825	1.90 \$
10 mm	MU1826	2.12 \$
12 mm	MU1827	2.55 \$
14 mm	MU1828	3.24 \$

Süper Turbo Elmas Testere (ince)

115 mm	MK0281	8.00 \$
180 mm	MK0282	12.50 \$

İnce Seramik Fayans Kesici Elmas Testere

115 mm	MES 661	7.80 \$
--------	---------	---------

Çok Amaçlı Elmas Testere

115 mm	MK0283	15.00 \$
--------	--------	----------



Sürekli Form Elmas Beton Testere

115 x 2.2 x 22.2 mm	51961	1.85 \$
180 x 2.4 x 22.2 mm	51962	4.90 \$
230 x 2.6 x 22.2 mm	51963	7.75 \$

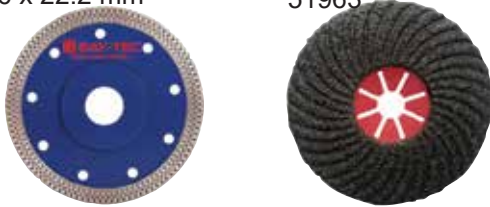

Premium Turbo Elmas Testere

115 mm	MK0282-4	8.90 \$
180 mm	MK0282-5	12.50 \$

Turbo Fiber Disk Zımpara

115 mm	MK0195	1.41 \$
180 mm	MK0196	3.90 \$



Ahşap Eğe Disk

115 mm	MK0286-16	5.10 \$
125 mm	MK0286-17	5.60 \$

Elmas Taşlama Silme Diski

115 mm	MK0286-20	8.65 \$
125 mm	MK0286-21	9.55 \$
180 mm	MK0286-22	18.80 \$





Saçaklı Daire Tel Fırça

80 mm	55310	2.36 \$
100 mm	55320	3.90 \$
125 mm	55330	4.05 \$
150 mm	55341	5.70 \$
175 mm	55351	6.90 \$
200 mm	55361	7.75 \$
250 mm	55371	18.30 \$
300 mm	55381	22.76 \$

Saçaklı Daire Tel Fırça

150 mm	MK1181	5.33 \$
175 mm	MK1182	5.60 \$
200 mm	MK1183	6.62 \$



Saçaklı Çanak Tel Fırça (0.30 mm Çelik Tel)

65 mm somunlu	MK1100	1.28 \$
75 mm somunlu	MK1110	1.35 \$
85 mm somunlu	MK1120	1.62 \$
100 mm somunlu	MK1130	2.08 \$

Saçaklı Çanak Paslanmaz Tel Fırça

65 mm somunlu paslanmaz	55545	2.95 \$
-------------------------	-------	---------



Burgulu Çanak Tel Fırça (0.50 mm Çelik Tel)

65 mm somunlu	MK1140	1.68 \$
75 mm somunlu	MK1150	1.82 \$
85 mm somunlu	MK1160	2.00 \$
100 mm somunlu	MK1170	2.75 \$

Burgulu Çanak Paslanmaz Tel Fırça

65 mm somunlu paslanmaz	55800	4.90 \$
-------------------------	-------	---------



Burgulu DaireTel Fırça (0.50 mm Çelik Tel)

150 mm	55347	6.77 \$
180 mm	55357	7.00 \$
200 mm	55367	7.50 \$



Plastik Saplı Tel Fırça

Normal	MK1240	0.81 \$
--------	--------	---------

Plastik Saplı Tel Fırça

Normal	MES 573	1.29 \$
--------	---------	---------

Plastik Saplı Tel Fırça

Normal	JUNIOR	0.66 \$
--------	--------	---------



Plastik Saplı Paslanmaz Tel Fırça	26000	1.90 \$
-----------------------------------	-------	---------



Pimli Çanak Tel Fırça

50 mm	MK1188	0.94 \$
65 mm	MK1189	1.05 \$
75 mm	MK1190	1.24 \$



Pimli Daire Tel Fırça

50 mm	MK1184	0.67 \$
65 mm	MK1185	0.73 \$
75 mm	MK1186	0.80 \$
100 mm	MK1187	1.20 \$

Pimli Daire Fırça

40x10 mm	56108	1.28 \$
50x10 mm	56109	1.56 \$
60x10 mm	56110	1.80 \$

Pimli Daire Paslanmaz Tel Fırça

40x10 mm	56111	1.28 \$
50x10 mm	56112	1.56 \$
60x10 mm	56113	1.80 \$



Pimli Kalem Tel Fırça

12 mm	MK1191	0.38 \$
17 mm	MK1192	0.40 \$
25 mm	MK1193	0.66 \$
30 mm	MK1194	0.95 \$

Pimli Kalem Paslanmaz Tel Fırça

17 mm	55905	0.84 \$
25 mm	55906	1.14 \$

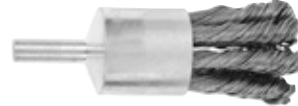

Pimli Kalem Burgulu Tel Fırça

25 mm	55908	1.92 \$
30 mm	55909	2.10 \$



Kalorifer Kazan Fırçası

60 mm	26100	67.00 TL
65 mm	26101	67.00 TL
70 mm	26102	67.00 TL
75 mm	26103	67.00 TL
80 mm	26104	67.00 TL
85 mm	26105	67.00 TL
90 mm	26106	67.00 TL

Ağaç Saplı Çelik Tel Fırça

No: 3	12 Adet/Paket	26010	46.50 TL
No: 4	12 Adet/Paket	26020	47.50 TL
No: 5	12 Adet/Paket	26030	52.10 TL
No: 6	12 Adet/Paket	26040	60.50 TL



**Inox Kesici Taş**115 x 1.0 x 22 mm
180 x 1.6 x 22 mmMK0190
MK01920.37 \$
0.85 \$**Inox Kesici Taş**

115 x 1.0 x 22 mm

MK0188

0.29 \$

Inox Kesici Taş115 x 1.0 x 22 mm
125 x 1.0 x 22 mm
180 x 1.6 x 22 mmMES 3301
MES 3311
MES 33020.47 \$
0.65 \$
1.58 \$**Metal Kesici Taş**115 x 2.5 x 22 mm
180 x 3.0 x 22 mm
230 x 3.0 x 22 mmMK0100
MK0110
MK01200.44 \$
1.17 \$
1.58 \$**Metal Taşlama Taş**

115 x 6.0 x 22 mm

MK0130

0.88 \$

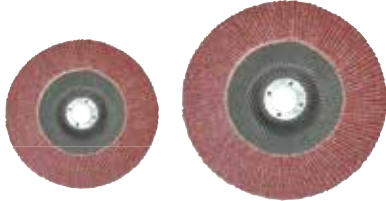
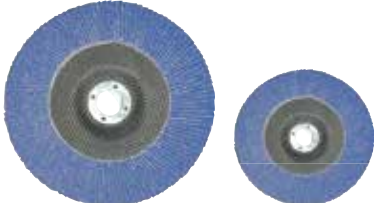
**Flap Disk Zımpara Alüminyum Oksit**115x 22 mm - 40 Kum
115x 22 mm - 60 Kum
115x 22 mm - 80 Kum
115x 22 mm - 100 Kum
115x 22 mm - 120 Kum
180x 22 mm - 60 KumMK0200
MK0210
MK0220
MK0220-1
MK0220-2
MK02210.70 \$
0.70 \$
0.70 \$
0.70 \$
0.70 \$
1.94 \$**Flap Disk Zımpara Alüminyum Oksit**115x 22 mm - 40 Kum
115x 22 mm - 60 Kum
115x 22 mm - 80 KumMES 220
MES 221
MES 2220.85 \$
0.85 \$
0.85 \$**Flap Disk Zımpara Zirkonyum**115x 22 mm - 40 Kum
115x 22 mm - 60 Kum
115x 22 mm - 80 KumMK0222
MK0223
MK02241.10 \$
1.10 \$
1.10 \$**Flap Disk Zımpara Zirkonyum, Orjinal**115x 22 mm - 40 Kum
115x 22 mm - 60 Kum
115x 22 mm - 80 KumMES 3350
MES 3351
MES 33521.33 \$
1.33 \$
1.33 \$**Flap Disk Zımpara Zirkonyum**115x 22 mm - 40 Kum
115x 22 mm - 60 Kum
115x 22 mm - 80 KumMES 224
MES 225
MES 2261.09 \$
1.09 \$
1.09 \$**Kesici Diskler**115 x 3.2 x 22 mm Metal T41
115 x 3.2 x 22 mm Metal T42
125 x 3.2 x 22 mm Metal T4154300 0.46 \$
54301 0.49 \$
54306 0.55 \$180 x 3 x 22 mm Metal T41
180 x 3.2 x 22 mm Metal T4254302 1.10 \$
54303 1.13 \$230 x 3 x 22 mm Metal T41
230 x 3.2 x 22 mm Metal T4254304 1.54 \$
54305 1.48 \$**Taşlama Diskler**100 x 6 x 16 mm Metal T27
115 x 6 x 22 mm Metal T27
125 x 6 x 22 mm Metal T2754310 0.88 \$
54311 0.88 \$
54317 0.95 \$180 x 6 x 22 mm Metal T27
180 x 6 x 22 mm Metal T27
180 x 10 x 22 mm Metal T2754312 1.90 \$
54313 1.98 \$
54314 2.10 \$230 x 4 x 16 mm Metal T27
230 x 6 x 22 mm Metal T27
230 x 7 x 22 mm Metal T2754315 1.90 \$
54316 2.40 \$
54318 2.50 \$**Kesici ve Taşlama Diskleri (Döküm, Tuğla, Çelik İçin)**115 x 3 x 22 mm Beton T41
180 x 3 x 22 mm Beton T41
230 x 3 x 22 mm Beton T41
115 x 6 x 22 mm Beton T27
180 x 6 x 22 mm Beton T2754321 0.63 \$
54323 1.28 \$
54324 1.94 \$
54320 1.01 \$
54329 2.29 \$180 x 8 x 16 mm Beton / DökümT27
230 x 6 x 22 mm Beton / DökümT2754328 2.53 \$
54326 3.53 \$**Metal Kesici Taş**355 x 3.0 x 25.4 mm Metal T41
400 x 4 x 25.4 mm Metal T41
400 x 5 x 40 mm Beton / DökümMK0123 3.50 \$
54398 4.20 \$
54327 4.20 \$**Metal Kesici Taş**

355 x 3.0 x 25.4 mm Metal T41

MES 3305 5.20 \$



Elyaf Flap Disk Zımpara

115 mm Gri (Paslanmaz Çelik)	54451	2.99 \$
115 mm Siyah (Paslanmaz Çelik)	54452	2.99 \$
115 mm Kırmızı (Alüminyum)	54453	2.99 \$
115 mm Beyaz 12P	54471	2.99 \$
115 mm Yeşil 12P	54481	3.49 \$
125 mm Gri (Paslanmaz Çelik)	54461	3.49 \$
125 mm Siyah (Paslanmaz Çelik)	54462	3.49 \$
125 mm Kırmızı (Alüminyum)	54463	3.49 \$



Sıkıştırılmış Elyaf Zımpara Taşları Paslanmaz Çelik Malzemeler için

200x25x20 mm 7PA 240 Kum - Yeşil	55165	7.62 \$
200x50x20 mm 7PA 240 Kum - Yeşil	55167	12.90 \$
250x30x25 mm 7PA 240 Kum - Yeşil	55168	12.40 \$
300x40x30 mm 7PA 240 Kum - Yeşil	55188	22.90 \$

Çelik Malzemeler için, Kalıp ve Bileme Amaçlı

200x25x20 mm 7PC 180 Kum - Kahverengi	55255	4.77 \$
200x30x30 mm 7PC 180 Kum - Kahverengi	55257	5.73 \$
250x30x25 mm 7PC 180 Kum - Kahverengi	55259	8.58 \$
250x50x25 mm 7PC 180 Kum - Kahverengi	55260	14.31 \$
300x40x30 mm 7PC 180 Kum - Kahverengi	55261	16.20 \$
350x50x25 mm 7PC 180 Kum - Kahverengi	55265	31.44 \$

Alüminyum, Bakır, Pirinç Malzemeler için

200x25x25 mm 4PB 320 Kum - Kırmızı	55205	4.40 \$
200x50x25 mm 4PB 320 Kum - Kırmızı	55207	8.88 \$
250x30x25 mm 4PB 320 Kum - Kırmızı	55240	8.88 \$



Polisaj Düz Keçe Flap Disk

115x22 mm	55035	3.25 \$
-----------	-------	---------



Mor Flap Disk (Silikon)

115x22 mm Pas silici, mor sert	55058	4.20 \$
125x22 mm Pas silici, mor sert	55059	7.95 \$
180x22 mm Pas silici, mor sert	55060	11.70 \$

Saplı Pas Silici Mor Disk (Silikon Bazlı)

100x13x6 mm, mor sert	55061	4.40 \$
-----------------------	-------	---------



Pas Silici Turuncu (Seramik bazlı)

100x13x6 mm	55065	4.40 \$
-------------	-------	---------



SK Flap Disk

115 mm Kırmızı Yumuşak	55075	17.33 €
115 mm Yeşil Sert	55076	17.33 €

Skoç Elyaf Flap Disk

115x22 - Medium AFM	55040	3.20 €
115x22 - Coarse AM	55041	4.44 €
115x22 - Fine AC	55042	3.62 €

Skoç Kombine Flap Disk

115x22 - Medium AFM	55043	4.03 €
115x22 - Coarse AM	55044	4.58 €
115x22 - Fine AC	55045	4.54 €



Polisaj Keçe Flap Disk 115 mm

Yatık Yaprak	55046	5.87 €
Dik Yaprak	55047	5.87 €

Polisaj Kombine Keçe Flap Disk 115 mm

Yatık Yaprak	55048	5.83 €
Dik Yaprak	55049	5.83 €



Düz Keçe Taban

115 mm, M14 somunlu	55036	6.22 €
---------------------	-------	--------



Yapışkan Temizleyici Disk

55081	8.70 \$
-------	---------



Pas Temizleyici Seti

55091	22.50 \$
-------	----------



Saplı Elyaf Mop Zımpara

25x15 mm	59240	1.11 €
25x20 mm	59241	1.14 €
25x25 mm	59242	1.17 €
25x30 mm	59243	1.19 €
30x15 mm	59244	1.10 €
30x20 mm	59245	1.12 €
30x25 mm	59246	1.28 €
30x30 mm	59247	1.31 €
40x20 mm	59248	1.27 €
40x25 mm	59249	1.33 €
40x30 mm	59250	1.40 €
40x40 mm	59251	1.52 €
50x20 mm	59252	1.42 €
50x30 mm	59253	1.56 €
50x40 mm	59254	1.84 €
60x15 mm	59255	1.48 €
60x20 mm	59256	1.64 €
60x30 mm	59265	2.10 €
60x40 mm	59257	2.47 €
60x50 mm	59258	2.73 €
80x15 mm	59259	2.31 €
80x20 mm	59260	2.60 €
80x25 mm	59261	2.87 €
80x30 mm	59262	3.15 €
80x40 mm	59263	3.60 €
80x50 mm	59264	4.00 €

Saplı Elyaf Mop Zımpara 10'lu Paket

30x20 mm	42745	11.20 €
40x20 mm	42748	12.70 €
50x20 mm	42752	14.20 €
60x30 mm	42765	21.00 €



Saplı Kombi Mop Zımpara

25x15 mm	59271	1.67 €
25x20 mm	59272	1.71 €
25x25 mm	59273	1.75 €
25x30 mm	59274	1.70 €
30x15 mm	59275	1.50 €
30x20 mm	59276	1.49 €
30x25 mm	59277	1.55 €
30x30 mm	59278	1.61 €
40x20 mm	59279	1.66 €
40x25 mm	59280	1.73 €
40x30 mm	59281	1.84 €
40x40 mm	59282	2.01 €
50x20 mm	59283	1.88 €
50x30 mm	59284	2.12 €
50x40 mm	59285	2.51 €
60x15 mm	59286	2.00 €
60x20 mm	59287	2.18 €
60x25 mm	59288	2.42 €
60x30 mm	59289	2.48 €
60x40 mm	59290	2.90 €
60x50 mm	59291	3.31 €
80x15 mm	59292	2.42 €
80x20 mm	59293	2.74 €
80x25 mm	59294	3.07 €
80x30 mm	59295	3.40 €
80x40 mm	59296	3.90 €
80x50 mm	59297	4.36 €

Saplı Kombi Elyaf Mop Zımpara 10'lu Paket

30x20 mm	42776	14.90 €
40x20 mm	42779	16.60 €
50x20 mm	42783	18.80 €
60x30 mm	42789	24.80 €

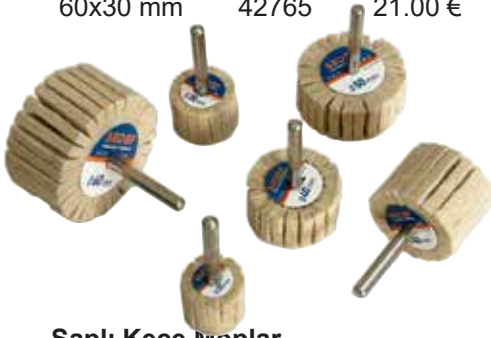

Saplı Keçe Moplar

20x15 mm	59301	2.38 €
20x20 mm	59302	2.38 €
25x20 mm	59303	2.38 €
30x15 mm	59304	2.38 €
30x20 mm	59305	2.46 €
30x30 mm	59306	2.58 €
40x20 mm	59307	2.75 €
40x30 mm	59308	2.90 €
50x20 mm	59309	3.03 €
50x30 mm	59310	3.21 €
50x40 mm	59311	3.45 €
60x30 mm	59313	3.94 €
60x40 mm	59314	4.60 €
60x50 mm	59315	5.46 €
80x30 mm	59318	5.70 €
80x40 mm	59319	5.97 €
80x50 mm	59320	6.49 €

Saplı Keçe Kombine Moplar

20x15 mm	59331	3.19 €
20x20 mm	59332	3.19 €
25x20 mm	59334	3.19 €
30x15 mm	59336	3.19 €
30x20 mm	59337	3.33 €
30x30 mm	59338	3.50 €
40x20 mm	59339	3.65 €
40x30 mm	59340	3.85 €
50x20 mm	59341	4.01 €
50x30 mm	59342	4.28 €
50x40 mm	59343	4.62 €
60x30 mm	59346	4.98 €
60x40 mm	59347	5.92 €
60x50 mm	59348	6.90 €
80x30 mm	59350	7.05 €
80x40 mm	59351	7.54 €
80x50 mm	59352	8.24 €



Roloc Disk

50 mm Alüminyum Oksit		
40 Kum	58900	0.85 €
60 Kum	58901	0.85 €
80 Kum	58902	0.79 €
120 Kum	58904	0.79 €

75 mm Alüminyum Oksit

60 Kum	58911	1.69 €
80 Kum	58912	1.69 €
120 Kum	58914	1.58 €

50 mm Zirkonyum

60 Kum	58921	1.21 €
80 Kum	58922	1.21 €
120 Kum	58924	1.09 €

75 mm Zirkonyum

60 Kum	58931	2.42 €
80 Kum	58932	2.42 €
120 Kum	58934	2.17 €



50 mm Elyaf

Sert	58940	0.50 €
Orta	58941	0.50 €
Yumuşak	58942	0.50 €

75 mm Elyaf

Sert	58950	1.10 €
Orta	58951	1.10 €
Yumuşak	58952	1.10 €

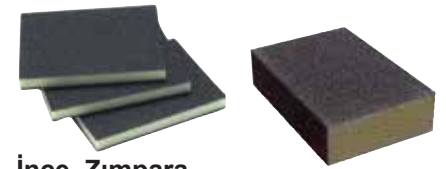

İnce Zımpara

60 Kum	58802	0.52 \$
80 Kum	58803	0.52 \$
100 Kum	58804	0.52 \$
120 Kum	58805	0.52 \$
150 Kum	58806	0.52 \$
180 Kum	58807	0.52 \$
220 Kum	58809	0.52 \$

Küçük Sünger Zımpara

60 Kum	58822	0.52 \$
80 Kum	58823	0.52 \$
100 Kum	58824	0.52 \$
120 Kum	58825	0.52 \$
150 Kum	58826	0.52 \$
180 Kum	58827	0.52 \$
220 Kum	58828	0.52 \$



Tabaka Skoç Zımparalar 230x280 mm

Sert AC		3.68 €
Kahverengi	54812	1.20 \$
Yeşil	54813	1.20 \$
Kırmızı	54814	1.20 \$



Saplı Zımpara Mop

20x15 mm-40 Kum	59011	0.98 €
20x15 mm-60 Kum	59012	1.06 €
20x15 mm-80 Kum	59013	1.06 €
20x20 mm-40 Kum	59017	1.98 €
20x20 mm-60 Kum	59018	1.06 €
20x20 mm-80 Kum	59019	1.06 €
20x25 mm-40 Kum	59023	1.06 €
20x25 mm-60 Kum	59024	1.10 €
20x25 mm-80 Kum	59025	1.10 €
20x30 mm-40 Kum	59029	1.27 €
20x30 mm-60 Kum	59030	1.32 €
20x30 mm-80 Kum	59031	1.32 €
25x15 mm-40 Kum	59035	1.11 €
25x15 mm-60 Kum	59036	1.14 €
25x15 mm-80 Kum	59037	1.14 €
25x20 mm-40 Kum	59041	1.16 €
25x20 mm-60 Kum	59042	1.19 €
25x20 mm-80 Kum	59043	1.19 €
25x30 mm-40 Kum	59051	1.28 €
25x30 mm-60 Kum	59052	1.37 €
25x30 mm-80 Kum	59053	1.37 €
30x15 mm-40 Kum	59057	0.83 €
30x15 mm-60 Kum	59058	0.88 €
30x15 mm-80 Kum	59059	0.88 €
30x20 mm-40 Kum	59063	0.88 €
30x20 mm-60 Kum	59064	0.92 €
30x20 mm-80 Kum	59065	0.92 €
30x30 mm-40 Kum	59074	0.98 €
30x30 mm-60 Kum	59075	1.00 €
30x30 mm-80 Kum	59076	1.00 €
40x10 mm-40 Kum	59085	0.88 €
40x10 mm-60 Kum	59086	0.88 €
40x10 mm-80 Kum	59087	0.92 €
40x15 mm-40 Kum	59091	0.93 €
40x15 mm-60 Kum	59092	1.00 €
40x15 mm-80 Kum	59093	1.00 €
40x20 mm-40 Kum	59097	0.96 €
40x20 mm-60 Kum	59098	1.08 €
40x20 mm-80 Kum	59099	1.08 €
40x30 mm-40 Kum	59107	1.18 €
40x30 mm-60 Kum	59108	1.31 €
40x30 mm-80 Kum	59109	1.40 €
40x40 mm-40 Kum	59113	1.36 €
40x40 mm-60 Kum	59114	1.57 €
40x40 mm-80 Kum	59115	1.68 €

50x15 mm-40 Kum	59119	1.01 €
50x15 mm-60 Kum	59120	1.10 €
50x15 mm-80 Kum	59121	1.10 €
50x20 mm-40 Kum	59125	1.15 €
50x20 mm-60 Kum	59126	1.27 €
50x20 mm-80 Kum	59127	1.29 €
50x30 mm-40 Kum	59137	1.50 €
50x30 mm-60 Kum	59138	1.68 €
50x30 mm-80 Kum	59139	1.72 €
50x40 mm-40 Kum	59144	1.83 €
50x40 mm-60 Kum	59145	2.07 €
50x40 mm-80 Kum	59146	2.13 €
60x15 mm-40 Kum	59157	1.28 €
60x15 mm-60 Kum	59158	1.43 €
60x15 mm-80 Kum	59159	1.43 €
60x20 mm-40 Kum	59163	1.43 €
60x20 mm-60 Kum	59164	1.54 €
60x20 mm-80 Kum	59165	1.54 €
60x30 mm-40 Kum	59171	1.75 €
60x30 mm-60 Kum	59172	1.86 €
60x30 mm-80 Kum	59173	1.86 €
60x40 mm-40 Kum	59177	2.25 €
60x40 mm-60 Kum	59178	2.54 €
60x40 mm-80 Kum	59179	2.61 €
60x50 mm-40 Kum	59183	2.58 €
60x50 mm-60 Kum	59184	2.93 €
60x50 mm-80 Kum	59185	3.03 €
80x20 mm-40 Kum	59195	2.15 €
80x20 mm-60 Kum	59196	2.39 €
80x20 mm-80 Kum	59197	2.51 €
80x30 mm-40 Kum	59201	2.99 €
80x30 mm-60 Kum	59202	3.35 €
80x30 mm-80 Kum	59203	3.52 €
80x40 mm-40 Kum	59208	3.81 €
80x40 mm-60 Kum	59209	4.30 €
80x40 mm-80 Kum	59210	4.53 €
80x50 mm-40 Kum	59214	4.64 €
80x50 mm-60 Kum	59215	5.25 €
80x50 mm-80 Kum	59216	5.55 €

Saplı Zımpara Mop 10'lu Paket

30x20 mm-60 Kum	42564	09.46 €
40x20 mm-60 Kum	42598	10.80 €
50x20 mm-60 Kum	42626	12.70 €
60x30 mm-60 Kum	42672	18.60 €

Spirobot için Lastik Takoz

10x30 mm	59480	1.35 €
12x30 mm	59481	1.35 €
15x30 mm	59482	1.73 €
20x30 mm	59483	1.73 €
25x30 mm	59484	2.48 €
30x30 mm	59485	2.48 €



Spirobot Zımparalar

10x30 mm - 40 Kum	59407	0.30 €
10x30 mm - 60 Kum	59408	0.30 €
10x30 mm - 100 Kum	59410	0.30 €
12x30 mm - 40 Kum	59415	0.30 €
12x30 mm - 60 Kum	59416	0.30 €
12x30 mm - 100 Kum	59418	0.30 €
15x30 mm - 40 Kum	59420	0.30 €
15x30 mm - 60 Kum	59421	0.30 €
15x30 mm - 100 Kum	59423	0.30 €
20x30 mm - 40 Kum	59430	0.45 €
20x30 mm - 60 Kum	59431	0.45 €
20x30 mm - 100 Kum	59433	0.45 €
20x30 mm - 40 Kum	59440	0.45 €
20x30 mm - 60 Kum	59441	0.45 €
20x30 mm - 100 Kum	59443	0.45 €
30x30 mm - 40 Kum	59450	0.45 €
30x30 mm - 60 Kum	59451	0.45 €
30x30 mm - 100 Kum	59453	0.45 €



Elyaf Rulo Zımpara

1.06m en, 120m boy 240	58991	1712.- \$
1.06m en, 120m boy 240	58992	1712.- \$
1.06m en, 120m boy 240	58990	937.- \$
1 mt en, (metre fiyatıdır)	58993	22.- €

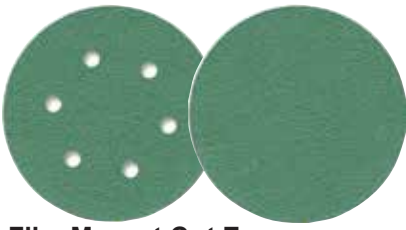

Film Mesnet Cırt Zımpara

6 delik, 150 mm

40 kum	58103	0.55 €
60 kum	58104	0.48 €
80 kum	58105	0.48 €
100 kum	58106	0.44 €
120 kum	58107	0.44 €
150 kum	58108	0.44 €
180 kum	58109	0.44 €
220 kum	58110	0.44 €
280 kum	58111	0.44 €
320kum	58112	0.44 €
400 kum	58113	0.44 €
600 kum	58114	0.44 €
800 kum	58115	0.44 €
1000 kum	58116	0.44 €
1200 kum	58117	0.44 €
1500 kum	58118	0.44 €
2000 kum	58119	0.44 €

Film Mesnet Cırt Zımpara

Deliksiz, 150 mm

40 kum	58073	0.55 €
60 kum	58074	0.48 €
80 kum	58075	0.48 €
100 kum	58076	0.44 €
120 kum	58077	0.44 €
150 kum	58078	0.44 €
180 kum	58079	0.44 €
220 kum	58080	0.44 €
280 kum	58081	0.44 €
320kum	58082	0.44 €
400 kum	58083	0.44 €
600 kum	58084	0.44 €
800 kum	58085	0.44 €



Film Mesnet Cırt Zımpara

Deliksiz, 115 mm

40 kum	58004	0.35 €
60 kum	58005	0.30 €
80 kum	58006	0.30 €
100 kum	58007	0.29 €
120 kum	58008	0.29 €
150 kum	58009	0.29 €
180 kum	58010	0.29 €
220 kum	58011	0.29 €
280 kum	58012	0.29 €
320kum	58013	0.29 €
400 kum	58014	0.29 €
600 kum	58015	0.29 €
800 kum	58016	0.29 €

Film Mesnet Cırt Zımpara

Deliksiz, 125 mm

60 kum	58035	0.34 €
80 kum	58036	0.34 €
100 kum	58037	0.33 €
120 kum	58038	0.33 €
150 kum	58039	0.33 €

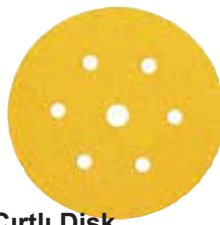

Gold Cırtlı Disk

6 Delik, 150 mm

40 kum	58233	0.51 €
60 kum	58234	0.44 €
80 kum	58235	0.44 €
100 kum	58236	0.40 €
120 kum	58237	0.40 €
150 kum	58238	0.40 €
180 kum	58239	0.40 €
220 kum	58240	0.40 €
280 kum	58241	0.40 €
320kum	58242	0.40 €
400 kum	58243	0.40 €
600 kum	58244	0.40 €
800 kum	58245	0.40 €

Gold Cırt Zımpara

Delikli, 125 mm

80 kum	58175	0.40 €
100 kum	58176	0.39 €
120 kum	58177	0.39 €
150 kum	58178	0.39 €



Alox Cırt Zımpara

6 delik, 150 mm

40 kum	58363	0.51 €
60 kum	58364	0.51 €
80 kum	58365	0.51 €
100 kum	58366	0.51 €
120 kum	58367	0.51 €
150 kum	58368	0.51 €
180 kum	58369	0.51 €
220 kum	58370	0.51 €
280 kum	58371	0.51 €
320kum	58372	0.51 €
400 kum	58373	0.51 €

Alox Cırt Zımpara

Deliksiz, 150 mm

40 kum	58333	0.59 €
60 kum	58334	0.55 €
80 kum	58335	0.54 €
100 kum	58336	0.51 €
120 kum	58337	0.51 €
150 kum	58338	0.51 €
180 kum	58339	0.51 €
220 kum	58340	0.51 €
280 kum	58341	0.51 €
320kum	58342	0.51 €
400 kum	58343	0.51 €



Skoç Elyaf Cırt Zımpara

150 mm 58960 0.52 \$

Skoç Elyaf Disk Zımpara

150 mm	58970	0.75 \$
180 mm	58980	4.35 \$



Rulo Bez Zımpara Sert Bez

20 cmx50 m toplarda, 1 metre fiyatlıdır.

36 kum	59513	5.78 €
40 kum	59514	5.30 €
50 kum	59515	5.30 €
60 kum	59516	5.15 €
80 kum	59517	5.04 €
100 kum	59518	4.99 €
120 kum	59519	4.99 €
150 kum	59520	4.99 €
180 kum	59521	4.99 €
220 kum	59522	4.99 €

Rulo Bez Zımpara Yumuşak Bez

20 cm x 5 mt toplarda, 1 metre fiyatlıdır.

280 kum	59542	5.09 €
320 kum	59543	5.09 €
400 kum	59444	5.09 €
600 kum	59545	5.09 €



Mavi Bez Zımpara

200x280 mm, %100 AIO2 zımpara tozu

No:4 - 40 Kum	58835	9.75 TL
No:3 - 60 Kum	58836	9.75 TL
No:2 - 80 Kum	58837	9.75 TL
No:1 - 100 Kum	58838	9.75 TL
No:0 - 120 Kum	58839	9.75 TL



GLORY MARKA, Sarı Lateks Kağıt

60 - 100 Kum AIO2	0.135 \$
120 - 220 Kum AIO2	0.135 \$
240 - 2000 Kum AIO2	0.135 \$

Su Zımparası

60 Kum	MK0257	0.115 \$
80 Kum	MK0258	0.115 \$
100 Kum	MK0259	0.115 \$
120 Kum	MK0260	0.115 \$
150 Kum	MK0261	0.115 \$
180 Kum	MK0262	0.115 \$
220 Kum	MK0263	0.115 \$

Su Zımparası

150 Kum	MES 4030	0.160 \$
180 Kum	MES 4031	0.160 \$
220 Kum	MES 4032	0.160 \$



Seramik Cırt Zımpara

Delikli, 150 mm	58391	0.66 €
-----------------	-------	--------



Flanşlı Mop Zımparalar

165x50x45 mm		
40 Kum	59672	14.32 €
60 Kum	59673	15.50 €
80 Kum	59674	17.10 €
100 Kum	59675	19.65 €

165x30x45 mm		
60 Kum	59663	11.09 €
80 Kum	59664	11.66 €

250x50x76 mm		
60 Kum	59683	33.23 €
80 Kum	59684	35.68 €



Kamalı Mop Zımparalar

100x100x19 mm		
40 Kum	59712	15.38 €
60 Kum	59713	15.69 €
80 Kum	59714	16.38 €



Flanşlı Elyaf Mop Zımparalar

165x50x25 mm		
Sert AM	59761	14.35 €
Orta Sert AFM	59762	11.85 €

165x30x25 mm		
Sert AM	59751	8.72 €
Orta Sert AFM	59752	7.25 €

165x30x45 mm		
Sert AM	59756	8.72 €
Orta Sert AFM	59757	7.25 €

165x50x45 mm		
Sert AM	59766	14.35 €
Orta Sert AFM	59767	11.85 €



Kamalı Elyaf Mop Zımparalar

100x100x19 mm		
Sert AM	59791	10.08 €
Orta Sert AFM	59792	9.45 €
Fine AC	59793	9.98 €

Kamalı Elyaf Mop Zımpara

110x100 mm	59794	15.30 €
------------	-------	---------

Kamalı Kombi Elyaf Mop Zımpara

110x100 mm	59822	15.30 €
------------	-------	---------



Flanşlı Kombine Mop Zımpara

165x30x25 mm	59801	8.80 €
165x30x45 mm	59802	8.80 €
165x50x25 mm	59804	14.30 €
165x50x45 mm	59806	14.30 €



Kamalı Kombine Mop Zımpara

100x100 mm		
80 kum AFM	59821	10.40 €

Kamalı Ondüle Elyaf Mop Zımpara

100x100x19 mm		
80 kum AFM	59796	24.33 €



Kamalı Keçe Mop

100x100x19 mm	59861	17.60 €
100x100x19 mm Kombi	59862	25.43 €



Somunlu Mop Zımpara

115x20 M14 -		
40 Kum		6.53 €
60 Kum		6.97 €
80 Kum		6.97 €



Dikişli Polisaj Fırça Bezi

200 mm	58720	11.80 \$/ kg
250 mm	58721	11.80 \$/ kg
300 mm	58722	11.80 \$/ kg
350 mm	58723	11.80 \$/ kg
400 mm	58724	11.80 \$/ kg
450 mm	58725	11.80 \$/ kg
500 mm	58726	11.80 \$/ kg



Polisaj Cilası

Mavi, 1 kg	58710	4.75 \$
Pembe, 1 kg	58712	4.75 \$
Kahverengi, 1 kg	58714	4.75 \$

Don Yağı	58715	3.50 \$/Adet
----------	-------	--------------



Köşe Pliseli Mop Zımpara

165 x M14		
60 Kum	59871	11.83 €
80 Kum	59872	11.83 €
165 x 22 mm		
60 Kum	59876	11.03 €
80 Kum	59877	11.03 €



Somunlu Elyaf Mop Zımpara

115x20 mm AC	59831	5.61 €
115x20 mm AFM	59832	4.55 €

Somunlu Kombine Elyaf Mop Zımpara

115x20 mm AC	59841	6.35 €
115x20 mm AFM	59842	5.67 €



Somunlu Keçe Mop Zımpara

115x20 mm	59851	8.22 €
-----------	-------	--------

Somunlu Keçe Kombine Mop Zımpara

115x20 mm	59852	10.43 €
-----------	-------	---------

Flanşlı Keçe Mop Zımpara

165x30x25 mm	59856	14.27 €
165x50x25 mm	59857	21.54 €



SK Flap Disk Zımpara

115 mm Kırmızı Yumuşak	55075	17.33 €
------------------------	-------	---------



SK Flap Disk Zımpara

115 mm Yeşil Sert		17.33 €
-------------------	--	---------



Sert Elyaf Kamalı Mop Zımpara

100x100x19 mm	59798	35.70 €
---------------	-------	---------



Viz Viz Kalıpcı Saplı Taşlama Seti
5 Parça MK1050 1.75 \$



Viz Viz Kalıpcı Saplı Taşlama Seti
10 Parça MK1052 2.85 \$



Tırpan Taşı Oval
9" MK1060 0.86 \$



Tırpan Taşı Oval Süper
9" MK1061 1.40 \$



SCG Bileme Taşı
150x50x25 MK1062 1.45 \$
200x50x20 MK1063 1.58 \$



EKR Bileme Taşı Süper
150x50x25 MK1065 2.20 \$
200x50x25 MK1066 2.45 \$



41 Parça Gravür Taşlama Seti
135 watt MES 926 47.82 \$



210 Parça Gravür Taşlama Seti
135 watt MES 924 75.65 \$



234 Parça Gravür Taşlama Seti
135 watt MES 927 65.22 \$



245 Parça Gravür Taşlama Seti
135 watt MES 925 108.70 \$



Gravür Seti 12 Parça MES 4151 4.5 \$
6 adet aşındırıcı taş, 6 adet tel fırça.
Dremel, Proxon gibi aletler için uygundur.



Gravür Seti 105 Parça MES 4580 6.12 \$
6 adet aşındırıcı taş, 6 adet tel fırça.
Dremel, Proxon gibi aletler için uygundur.



Saplı Taşlar - A Form		EKR
A-01	12x4	150 Adet/Pk 27.60 TL
A-02	16x4	150 Adet/Pk 27.60 TL
A-03	16x8	150 Adet/Pk 27.60 TL
A-04	20x4	150 Adet/Pk 27.60 TL
A-05	20x8	150 Adet/Pk 27.60 TL
A-06	20x16	150 Adet/Pk 37.40 TL
A-07	25x4	150 Adet/Pk 37.40 TL
A-08	25x8	150 Adet/Pk 37.40 TL
A-09	25x10	150 Adet/Pk 37.40 TL
A-10	25x20	150 Adet/Pk 37.40 TL
A-11	30x4	150 Adet/Pk 37.40 TL
A-12	30x8	150 Adet/Pk 37.40 TL
A-13	30x16	150 Adet/Pk 37.40 TL
A-14	30x20	150 Adet/Pk 55.00 TL
A-15	40x6	150 Adet/Pk 55.00 TL
A-16	40x10	150 Adet/Pk 60.20 TL
A-17	40x16	150 Adet/Pk 60.20 TL
A-18	40x20	150 Adet/Pk 60.20 TL
A-19	50x10	150 Adet/Pk 72.90 TL
A-20	50x16	150 Adet/Pk 72.90 TL
A-21	50x20	150 Adet/Pk 72.90 TL
A-22	60x16	150 Adet/Pk 103.35 TL
A-23	60x20	150 Adet/Pk 103.35 TL



Saplı Taşlar - B Form		EKR
B-01	3x8	100 Adet/Pk 25.35 TL
B-02	4x8	100 Adet/Pk 25.35 TL
B-03	5x10	100 Adet/Pk 25.35 TL
B-04	6x12	100 Adet/Pk 25.35 TL
B-05	6x16	100 Adet/Pk 25.35 TL
B-06	8x12	100 Adet/Pk 25.35 TL
B-07	8x16	100 Adet/Pk 25.35 TL
B-08	10x10	100 Adet/Pk 25.35 TL
B-09	10x15	100 Adet/Pk 35.00 TL
B-10	10x20	100 Adet/Pk 35.00 TL
B-11	10x25	100 Adet/Pk 35.00 TL
B-	10x30	100 Adet/Pk 35.00 TL
B-12	12x12	100 Adet/Pk 35.00 TL
B-13	12x20	50 Adet/Pk 37.40 TL
B-	12x25	50 Adet/Pk 37.40 TL
B-14	12x30	50 Adet/Pk 37.40 TL
B-15	16x16	50 Adet/Pk 37.40 TL
B-16	16x20	50 Adet/Pk 37.40 TL
B-17	16x25	50 Adet/Pk 37.40 TL
B-18	16x30	50 Adet/Pk 37.40 TL
B-	16x40	50 Adet/Pk 39.65 TL
B-19	20x20	50 Adet/Pk 39.64 TL
B-20	20x30	50 Adet/Pk 39.65 TL
B-21	20x40	50 Adet/Pk 44.90 TL
B-22	25x25	50 Adet/Pk 44.90 TL
B-23	25x32	50 Adet/Pk 49.80 TL
B-24	25x40	50 Adet/Pk 49.80 TL
B-25	25x50	50 Adet/Pk 57.80 TL
B-26	30x30	50 Adet/Pk 57.80 TL
B-27	30x40	50 Adet/Pk 62.95 TL
B-28	30x50	50 Adet/Pk 78.15 TL
B-29	40x40	50 Adet/Pk 97.00 TL



Sabun Taşı Turuncu		HK
150x50x25 mm		
HK60 Kum		400.00 TL
HK80 Kum		400.00 TL
HK100 Kum		400.00 TL
HK120 Kum		400.00 TL

Sabun Taşı Beyaz		EKW
150x50x25 mm		
EKW60 Kum		400.00 TL
EKW80 Kum		400.00 TL
EKW100 Kum		400.00 TL
EKW120 Kum		400.00 TL



Şeytan Taşı			
50x20x20	27862	175.00 TL	
150x50x25	27864	525.00 TL	



Kombine Yağ Taşları		EKR
100x25x16	10 Adet/Pk	191.00 TL
125x40x20	10 Adet/Pk	294.00 TL
150x50x25	10 Adet/Pk	458.00 TL
200x50x25	10 Adet/Pk	595.00 TL

Kombine Yağ Taşları		SCG
100x25x16	10 Adet/Pk	250.00 TL
125x40x20	10 Adet/Pk	353.00 TL
150x50x25	10 Adet/Pk	525.00 TL
200x50x25	10 Adet/Pk	712.00 TL



Saplı Taşlar - E Form		EKR
E-01	5x5	100 Adet/Pk 31.96 TL
E-02	5x10	100 Adet/Pk 31.96 TL
E-03	8x16	100 Adet/Pk 31.96 TL
E-04	8x20	100 Adet/Pk 31.96 TL
E-05	10x20	100 Adet/Pk 41.97 TL
E-06	10x30	100 Adet/Pk 41.97 TL
E-07	12x20	100 Adet/Pk 41.97 TL
E-07	12x25	100 Adet/Pk 41.97 TL
E-08	12x30	100 Adet/Pk 41.97 TL
E-09	12x40	100 Adet/Pk 46.35 TL
E-10	16x16	100 Adet/Pk 46.35 TL
E-11	16x32	100 Adet/Pk 46.35 TL
E-12	16x40	50 Adet/Pk 46.35 TL
E-13	20x20	50 Adet/Pk 55.10 TL
E-14	20x30	50 Adet/Pk 55.10 TL
E-15	20x40	50 Adet/Pk 69.25 TL
E-16	25x25	50 Adet/Pk 69.25 TL
E-17	25x32	50 Adet/Pk 69.25 TL
E-18	25x40	50 Adet/Pk 69.25 TL
E-19	32x32	50 Adet/Pk 92.95 TL
E-20	32x40	50 Adet/Pk 92.95 TL
E-21	32x50	50 Adet/Pk 100.65 TL

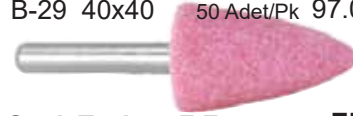

Saplı Taşlar - F Form		EKR
F-01	8x16	50 Adet/Pk 52.87 TL
F-02	13x20	50 Adet/Pk 52.87 TL
F-03	20x32	50 Adet/Pk 57.30 TL
F-04	20x40	50 Adet/Pk 57.30 TL



Saplı Taşlar - D Form		EKR
D-01	8x20	50 Adet/Pk 41.85 TL
D-02	10x25	50 Adet/Pk 51.70 TL
D-03	12x20	50 Adet/Pk 51.70 TL
D-04	16x25	50 Adet/Pk 52.80 TL
D-05	20x35	50 Adet/Pk 64.05 TL



Saplı Taşlar - H Form		EKR
H-01	8	100 Adet/Pk 47.50 TL
H-02	10	100 Adet/Pk 47.50 TL
H-03	12	100 Adet/Pk 52.95 TL
H-04	15	100 Adet/Pk 52.95 TL
H-05	20	50 Adet/Pk 52.95 TL
H-06	25	50 Adet/Pk 71.20 TL
H-07	30	50 Adet/Pk 90.50 TL
H-08	32	50 Adet/Pk 104.50 TL
H-08	40	126.00 TL



Saplı Taşlar - G Form		EKR
G-01	20x16/12x10	50 Adet/Pk 52.87 TL
G-02	25x20/15x12	50 Adet/Pk 67.85 TL
G-03	32x25/20x15	50 Adet/Pk 86.35 TL
G-04	40x32/24x20	50 Adet/Pk 86.35 TL

Saplı Taşlar - C Form		EKR
C-01	25x8	50 Adet/Pk 60.10 TL
C-02	30x8	50 Adet/Pk 67.85 TL
C-03	40x10	50 Adet/Pk 72.50 TL
C-04	50x12	50 Adet/Pk 76.75 TL



Saplı Taşlar - K Form		EKR
K-01	20x16/12x10	50 Adet/Pk 52.90 TL
K-02	25x20/15x12	50 Adet/Pk 67.85 TL
K-03	32x25/20x15	50 Adet/Pk 106.50 TL
K-04	40x32/24x20	50 Adet/Pk 106.50 TL



Gaz ve Honlama Taşları Yuvarlak, Üçgen, Kare		EKR
100x8x8	10 Adet/Pk	85.25 TL
100x10x10	10 Adet/Pk	93.20 TL
100x12x12	10 Adet/Pk	105.50 TL
125x12x12	10 Adet/Pk	105.50 TL
150x10x10	10 Adet/Pk	105.00 TL
150x12x12	10 Adet/Pk	118.00 TL
150x13x13	10 Adet/Pk	124.00 TL
150x15x15	10 Adet/Pk	147.00 TL
150x20x20	10 Adet/Pk	213.00 TL
150x25x25	10 Adet/Pk	294.00 TL
150x50x25	10 Adet/Pk	525.00 TL
200x20x20	10 Adet/Pk	259.00 TL
200x50x25	10 Adet/Pk	685.00 TL

Gaz ve Honlama Taşları Yuvarlak, Üçgen, Kare		SCG
100x8x8	10 Adet/Pk	95.25 TL
100x10x10	10 Adet/Pk	104.00 TL
100x12x13	10 Adet/Pk	121.00 TL
150x10x10	10 Adet/Pk	121.00 TL
150x12x12	10 Adet/Pk	142.00 TL
150x15x15	10 Adet/Pk	184.00 TL
150x20x20	10 Adet/Pk	279.00 TL
150x25x25	10 Adet/Pk	395.00 TL
150x50x25	10 Adet/Pk	728.00 TL
200x20x20	10 Adet/Pk	345.00 TL
200x50x25	10 Adet/Pk	956.00 TL

Makita Tip Yün İplik Polisaj Başlık



54436

11.33 \$

Oto Pasta Süngeri

M14 dişi vidalı bağlantı
150 mm



54435

5.38 \$

Pasta Polisaj Süngeri 150 mm

M14 Bağlantı
Cırtlı Ped
Yumurta Ped

MK0225-4
MK0225-8
MK0225-10

2.50 \$
1.38 \$
1.38 \$



Cırtlı Sert PU Polisaj Taban

80x6mm

50720

6.90 \$

Cırtlı Yumurta Polisaj Sünger

80x25mm

50725

3.15 \$



Cırt Zımparalar (Delikli -Deliksiz)

Ekzantrikli zımpara makinaları için 40-60 -80 -100 kum alüminyum oksit zımparalar

115 mm, 40 Kum	MK0241	0.84 \$
115 mm, 60 Kum	MK0242	0.84 \$
115 mm, 80 Kum	MK0243	0.84 \$
115 mm, 100 Kum	MK0244	0.84 \$
115 mm, 120 Kum	MK0245	0.84 \$
115 mm, 150 Kum	MK0245-1	0.84 \$
115 mm, 180 Kum	MK0245-2	0.84 \$
180 mm, 40 Kum	MK0246	0.20 \$
180 mm, 60 Kum	MK0247	0.20 \$
180 mm, 80 Kum	MK0248	0.20 \$
180 mm, 100 Kum	MK0249	0.20 \$
180 mm, 120 Kum	MK0250	0.20 \$
180 mm, 150 Kum	MK0251	0.20 \$
180 mm, 180 Kum	MK0251-01	0.20 \$
225 mm, 120 Kum	MK0253	0.32 \$

Koton Daire Fırça

90x19 mm
150x19 mm
200x19 mm
parlatma işleri için

58740
58741
58742

2.20 \$
3.56 \$
5.20 \$



Masif Temizleme Fırçası

160x50 mm
180x50 mm

58755
58756

12.20 \$
14.05 \$

ÖZİPEKLİLER

TEKNİK HIRDAVAT - ÇELİK TİCARET VE SAN. A.Ş. 22.04.2024

Cırt Zımpara Disk Altlığı

cırtlı zımparalara uygun, M14 dişi vidalı bağlantı

115 mm	54432/MK0226	1.06 \$
150 mm		4.20 \$
180 mm	54433/MK0228	1.93 \$

Cırt Zımpara 6'lı Cırt Yedekli

6 cırt zımpara yedekli

115 mm	MK0230	1.38 \$
180 mm	MK0240	3.45 \$

Cırt Zımpara Disk Altlığı

cırtlı zımparalara uygun, M14 dişi vidalı bağlantı

115 mm	MES 4105	1.28 \$
--------	----------	---------

Cırt Zımpara 6'lı Cırt Yedekli

6 cırt zımpara yedekli

115 mm	MES 230	1.75 \$
--------	---------	---------

Plastik Fiber Disk Altlığı

115 mm	54410	0.85 \$
180 mm	54420	1.40 \$

Deliksiz Sünger Altlık

Cırtlı zımparalara uygun, M14 dişi vidalı bağlantılı

125 mm	54425	3.75 \$
150 mm	54426	4.50 \$

Ekzantrik Zımpara Polisaj Tabanı Cırtlı 6 Delikli Altlık

Cırtlı zımparalara uygun, 5/16x24 erkek vidalı bağlantılı

150 mm	54445	4.45 \$
--------	-------	---------

Ekzantrik Zımpara Polisaj Tabanı Yapışkanlı 6 Delikli Altlık

Yapışkanlı zımparalara uygun, 5/16x24 erkek vidalı bağlantılı

150 mm	54446	4.45 \$
--------	-------	---------

Cırtlı Sünger Ara Taban Ekzantrik Zımpara Altlık

7 delikli, 150 mm

54444

3.60 \$

İpli Peluş Polisaj Başlığı

115 mm ipli	54451	0.25 \$
180 mm ipli	54443	0.35 \$

Cırtlı Peluş Polisaj Başlığı

115 mm cırtlı	54447	0.20 \$
150 mm cırtlı	54448	0.25 \$
180 mm cırtlı	54449	0.35 \$





Egesan Plus Seri Metal Taşlama Taşları

115x6.0x22.23 T27 - A 24 S BF	43.15 TL
180x6.0x22.23 T27 - A 24 S BF	82.12 TL
180x8.0x22.23 T27 - A 24 S BF	100.92 TL



Egesan Pro Metal Kesme Taşları

115x3.0x23 T41 - A 30 R BF	22.27 TL
125x3.0x23 T41 - A 30 R BF	24.36 TL
180x3.0x23 T41 - A 30 R BF	38.97 TL
230x3.0x23 T41 - A 30 R BF	65.42 TL



Egesan Plus Seri Metal Kesme Taşları

115x3.0x22.23 T41 - A 30 S BF	23.84 TL
180x3.0x22.23 T41 - A 30 S BF	41.76 TL
230x3.0x22.23 T41 - A 30 S BF	70.29 TL



Egesan Pro Seri Metal Taşlama Taşları

115x6.0x23 T27 - A 24 R BF	39.67 TL
125x6.0x23 T27 - A 24 R BF	45.24 TL
180x6.0x23 T27 - A 24 R BF	76.56 TL
180x8.0x23 T27 - A 24 R BF	93.96 TL
180x10.0x23 T27 - A 24 R BF	128.75 TL
230x6.0x23 T27 - A 24 R BF	135.71 TL
230x8.0x23 T27 - A 24 R BF	163.55 TL
230x10.0x23 T27 - A 24 R BF	205.31 TL



Egesan Pro Seri Pik Döküm Kesme Taşları

115x3.0x22.23 T41 - CA 30 R BF	25.75 TL
180x3.0x22.23 T41 - CA 30 R BF	45.24 TL
230x3.0x22.23 T41 - CA 30 R BF	80.04 TL



Egesan Pro Seri Mermer Kesme Taşları

115x3.0x22.23 T41 - C 30 R BF	27.14 TL
180x3.0x22.23 T41 - C 30 R BF	46.63 TL
230x3.0x22.23 T41 - C 30 R BF	83.52 TL



Egesan Pro Seri Inox İnce Kesme Taşları

115x1.0x22.23 T41 INOX - A 60 T BF	16.70 TL
125x1.0x22.23 T41 INOX - A 60 T BF	20.53 TL
180x1.6x22.23 T41 INOX - A 60 T BF	39.67 TL
180x1.9x22.23 T41 INOX - A 60 T BF	42.45 TL
230x1.9x22.23 T41 INOX - A 60 T BF	65.51 TL



Egesan Pro Seri Mermer Taşlama Taşları

115x6.0x23 T27 - C 24 R BF	46.63 TL
125x6.0x23 T27 - C 24 R BF	55.68 TL
180x6.0x23 T27 - C 24 R BF	90.48 TL
180x8.0x23 T27 - C 24 R BF	111.36 TL
230x6.0x23 T27 - C 24 R BF	149.63 TL
230x8.0x23 T27 - C 24 R BF	178.17 TL



Egesan Black Seri Inox İnce Kesme Taşları

115x1.0x22.23 T41 INOX - A 60 S BF	14.62 TL
125x1.0x22.23 T41 INOX - A 60 S BF	17.75 TL



Egesan Pro Seri Sabit Tezgah Kesme Taşları Metal Kesme için

300x3.0x25.4 T41 - A 30 R BF	112.15 TL
300x3.0x30.0 T41 - A 30 R BF	137.37 TL
350x2.8x25.4 T41 - A 30 R BF	132.29 TL
350x3.5x25.4 T41 - A 30 R BF	150.80 TL
350x3.5x30.0 T41 - A 30 R BF	150.80 TL



Egesan NK Taşlama Taşları

75x13x10	24 / 36 / 46 / 60 Kum	184.13 TL
100x13x10	24 / 36 / 46 / 60 Kum	187.91 TL
100x16x20	24 / 36 / 46 / 60 Kum	201.83 TL
100x20x20	24 / 36 / 46 / 60 Kum	229.67 TL
125x16x16	24 / 36 / 46 / 60 Kum	264.47 TL
125x20x20	24 / 36 / 46 / 60 Kum	281.87 TL
150x20x20	24 / 36 / 46 / 60 Kum	358.42 TL
150x25x20	24 / 36 / 46 / 60 Kum	434.98 TL
175x20x20	24 / 36 / 46 / 60 Kum	487.18 TL
175x25x20	24 / 36 / 46 / 60 Kum	577.66 TL
200x20x20	24 / 36 / 46 / 60 Kum	612.45 TL
200x25x20	24 / 36 / 46 / 60 Kum	741.21 TL
200x30x20	24 / 36 / 46 / 60 Kum	876.92 TL
200x32x25	24 / 36 / 46 / 60 Kum	922.16 TL
250x25x25	24 / 36 / 46 / 60 Kum	1148.35 TL
250x30x25	24 / 36 / 46 / 60 Kum	1367.58 TL
250x32x25	24 / 36 / 46 / 60 Kum	1433.70 TL
250x40x25	24 / 36 / 46 / 60 Kum	1760.81 TL
300x30x30	24 / 36 / 46 / 60 Kum	2108.79 TL
300x32x30	24 / 36 / 46 / 60 Kum	2296.70 TL
300x40x32	24 / 36 / 46 / 60 Kum	2714.29 TL
350x32x40	24 / 36 / 46 / 60 Kum	3288.46 TL
350x40x40	24 / 36 / 46 / 60 Kum	3862.64 TL
400x40x40	24 / 36 / 46 / 60 Kum	5045.79 TL



Egesan EKR / EKW Çelik Taşlama Taşı

125x20x20	46 / 60 Kum	382.78 TL
150x20x20	46 / 60 Kum	416.59 TL
150x25x20	46 / 60 Kum	459.34 TL
175x20x20	46 / 60 Kum	524.52 TL
175x25x20	46 / 60 Kum	591.58 TL
200x20x20	46 / 60 Kum	666.51 TL
200x25x20	46 / 60 Kum	782.97 TL
250x25x76	46 / 60 Kum	1175.48 TL
250x30x76	46 / 60 Kum	1382.49 TL
250x32x76	46 / 60 Kum	1463.58 TL
350x40x127	46 / 60 Kum	3368.35 TL
350x50x127	46 / 60 Kum	4135.46 TL
400x40x217	46 / 60 Kum	4518.76 TL
400x50x217	46 / 60 Kum	5655.57 TL



Egesan Testere Taşlama Taşları

150x6.0x20 EKR	187.91 TL
150x8.0x20 EKR	212.27 TL
150x10.0x20 EKR	228.28 TL
175x8.0x20 EKR	242.36 TL
175x10.0x20 EKR	270.74 TL
200x8.0x20 EKR	294.05 TL
200x10.0x20 EKR	334.88 TL
250x10.0x25 EKR	538.31 TL

150x6.0x20 NK	191.37 TL
150x8.0x20 NK	204.46 TL
150x10.0x20 NK	227.98 TL
175x8.0x20 NK	217.77 TL
175x10.0x20 NK	242.87 TL
200x8.0x20 NK	255.49 TL
200x10.0x20 NK	295.26 TL
250x10.0x25 NK	454.00 TL



Egesan SCG Elmas Bileme Taşları

125x20x20	313.19 TL
150x20x20	386.96 TL
150x25x20	472.56 TL
175x20x20	510.15 TL
175x25x20	581.14 TL
200x20x20	629.85 TL
200x25x20	750.95 TL
200x32x20	986.89 TL
250x25x25	1228.39 TL
250x32x25	1475.46 TL
300x30x30	2147.07 TL
300x32x30	2280.00 TL
300x40x32	2783.88 TL



Egesan Çanak Taşları

	EKR	EKW
D-50 Düz	46 / 60 Kum 171.76 TL	171.76 TL
D-75 Düz	46 / 60 Kum 208.49 TL	208.49 TL
D-100 Düz	46 / 60 Kum 259.77 TL	259.77 TL
D-125 Düz	46 / 60 Kum 439.42 TL	439.42 TL
D-150 Düz	46 / 60 Kum 714.15 TL	714.15 TL

E-50 Konik	46 / 60 Kum 165.10 TL	165.10 TL
E-75 Konik	46 / 60 Kum 172.15 TL	172.15 TL
E-100 Konik	46 / 60 Kum 204.50 TL	204.50 TL
E-125 Konik	46 / 60 Kum 288.06 TL	288.06 TL
E-150 Konik	46 / 60 Kum 383.65 TL	383.65 TL



Egesan Burçlu Mozaik Silme Taşları SC

100x45x14 Konik	217.67 TL
130x45x14 Konik	289.54 TL

Egesan Flanşlı Metal Mozaik Silme Taşları SC

110x58x22,23 Konik - 24 Kum SC	283.15 TL
--------------------------------	-----------



Egesan Rulo Sünger Zımpara

115 mm	38.04 TL/mt
25 mt/kutu	



Egesan Pro Seri AO Flap Diskler	40 Kum	60 Kum	80 Kum
115x22.23 T42	45.40 TL	44.09 TL	42.98 TL
125x22.23 T42	55.63 TL	53.38 TL	53.38 TL
180x22.23 T42	108.56 TL	106.99 TL	106.99 TL



Egesan Cirt Zımpara Film Mesnetli (Yeşil)

115 - 40 Kum	6.27 TL
115 - 60 Kum	6.06 TL
115 - 80 Kum	6.06 TL
115 - 100 Kum	5.78 TL
115 - 120-400 Kum	5.54 TL
125 - 40 Kum	7.57 TL
125 - 60 Kum	7.32 TL
125 - 80 Kum	7.32 TL
125 - 100 Kum	6.99 TL
125 - 120-400 Kum	6.70 TL

Egesan Pro Seri ZR Flap Diskler

Egesan Pro Seri ZR Flap Diskler	40 Kum	60 / 80 Kum
115x22.23 T42	51.56 TL	48.67 TL
125x22.23 T42	62.48 TL	61.17 TL
180x22.23 T42	111.81 TL	107.86 TL



Egesan Quality Seri AO Flap Diskler

Egesan Quality Seri AO Flap Diskler	40 Kum	60 Kum	80 Kum
115x22.23 T42	41.42 TL	40.80 TL	40.18 TL
125x22.23 T42	51.33 TL	49.48 TL	49.10 TL
180x22.23 T42	100.07 TL	98.58 TL	98.45 TL

Egesan Quality Seri ZR Flap Diskler

Egesan Quality Seri ZR Flap Diskler	40 Kum	60 / 80 Kum
115x22.23 T42	45.24 TL	43.35 TL
125x22.23 T42	55.30 TL	54.31 TL
180x22.23 T42	98.70 TL	97.96 TL



Egesan Su Zımpara

230x280 mm	
60 Kum	20.75 TL
80 Kum	20.75 TL
100 Kum	20.75 TL
120 Kum	20.75 TL
150 Kum	20.75 TL
180 Kum	20.75 TL
220 - 500 Kum	20.75 TL
600 - 1200 Kum	20.75 TL

Egesan Elyaf Plaka Zımpara

Sert - Açık Kırmızı	66.27 TL
180 Kum	
Orta - Koyu Kırmızı	52.82 TL
200 Kum	
Yumuşak - Kırmızı	66.27 TL
240 Kum	
Orta - Yeşil	52.82 TL
280 Kum	

Egesan Fiber Diskler AO (A) Metal

115 x 22.23 - 16 Kum	15.78 TL
115 x 22.23 - 24 Kum	15.78 TL
115 x 22.23 - 36 Kum	13.78 TL
115 x 22.23 - 40 Kum	13.78 TL
115 x 22.23 - 50 Kum	13.78 TL
115 x 22.23 - 60 Kum	11.95 TL
115 x 22.23 - 80 Kum	11.70 TL
115 x 22.23 - 100 Kum	11.70 TL
115 x 22.23 - 120 Kum	11.70 TL
180 x 22.23 - 16 Kum	36.53 TL
180 x 22.23 - 24 Kum	36.53 TL
180 x 22.23 - 36 Kum	31.91 TL
180 x 22.23 - 40 Kum	31.91 TL
180 x 22.23 - 50 Kum	31.91 TL
180 x 22.23 - 60 Kum	27.52 TL
180 x 22.23 - 80 Kum	27.09 TL
180 x 22.23 - 100 Kum	27.09 TL
180 x 22.23 - 120 Kum	27.09 TL



Egesan Rulo Bez Zımpara AC X 412

200 - 40 Kum	65.98 TL
200 - 60 Kum	60.42 TL
200 - 80 Kum	56.40 TL
200 - 100 Kum	52.87 TL
200 - 120 Kum	50.35 TL
200 - 150 Kum	50.35 TL
200 - 180 Kum	50.35 TL
200 - 220 Kum	50.35 TL

Egesan Rulo Bez Zımpara AC X 412

250 - 40 Kum	88.29 TL
250 - 60 Kum	76.49 TL
250 - 80 Kum	71.34 TL
250 - 100 Kum	66.85 TL
250 - 120 Kum	63.76 TL
250 - 150 Kum	64.29 TL
250 - 180 Kum	63.05 TL
250 - 220 Kum	64.18 TL

Egesan Sonsuz Bant Zımpara AC X 412

1150 x 100 mm - 40 Kum	84.94 TL
1150 x 100 mm - 60 Kum	77.37 TL
1150 x 100 mm - 80 Kum	73.41 TL
1250 x 100 mm - 40 Kum	89.53 TL
1250 x 100 mm - 60 Kum	81.34 TL
1250 x 100 mm - 80 Kum	77.13 TL





NK



INOX

Karbosan İnce Kesiciler (Thin Line)

115x1.0x22 NK A54 R (25 Adet/Paket)	18.00 TL
125x1.0x22 NK A54 R (25 Adet/Paket)	20.07 TL
180x1.9x22 NK A54 R (15 Adet/Paket)	
115x1.0x22 INOX A54 R (25 Adet/Paket)	14.92 TL
125x1.0x22 INOX A54 R (25 Adet/Paket)	18.21 TL
180x1.9x22 INOX A54 R (25 Adet/Paket)	39.70 TL



NK



SC

Karbosan Sabit Tezgaah Kesme Diskleri

300x3.0x25.4 NK A30 P (20 Adet/Paket)	118.24 TL
300x3.0x30 NK A30 P (20 Adet/Paket)	118.24 TL
350x3.5x30 NK A30 P (10 Adet/Paket)	170.45 TL
350x3.5x25.4 NK A30 P (10 Adet/Paket)	164.66 TL
400x4.0x40 NK A30 P (20 Adet/Paket)	265.76 TL
300x3.0x30 SC C24 S (20 Adet/Paket)	
350x3.5x30 SC C24 S (20 Adet/Paket)	
400x4.0x40 SC C24 S (20 Adet/Paket)	



NK



INOX



SC

Karbosan Metal Kesme Taşları (DÜZ-BOMBELİ)

115x3.0x22 NK A36 T (50 Adet/Paket)	20.12 TL
180x3.0x22 NK A36 T (25 Adet/Paket)	37.06 TL
230x3.0x22 NK A36 T (15 Adet/Paket)	61.97 TL
115x2.5x22 INOX A30 T (25 Adet/Paket)	
180x3.0x22 INOX A30 T (25 Adet/Paket)	
230x3.0x22 INOX A30 T (25 Adet/Paket)	
115x2.5x22 SC A30 S (50 Adet/Paket)	23.59 TL
180x3.0x22 SC A30 S (25 Adet/Paket)	44.88 TL
230x3.0x22 SC A30 S (25 Adet/Paket)	77.43 TL

Karbosan NK Zımpara Taşları

75x13x10 (5 Adet/Paket)	36 Kum / 40 Kum	182.00 TL
100x13x10 (5 Adet/Paket)	36 Kum / 40 Kum	185.00 TL
100x16x20 (5 Adet/Paket)	36 Kum / 40 Kum	198.00 TL
125x16x16 (5 Adet/Paket)	36 Kum / 40 Kum	266.00 TL
125x20x20 (5 Adet/Paket)	36 Kum / 40 Kum	278.00 TL
150x20x20 (5 Adet/Paket)	36 Kum / 40 Kum	338.00 TL
150x25x20 (5 Adet/Paket)	36 Kum / 40 Kum	412.00 TL
175x20x20 (5 Adet/Paket)	36 Kum / 40 Kum	462.00 TL
175x25x20 (5 Adet/Paket)	36 Kum / 40 Kum	548.00 TL
200x20x20 (5 Adet/Paket)	36 Kum / 40 Kum	581.00 TL
200x25x20 (5 Adet/Paket)	36 Kum / 40 Kum	701.00 TL
200x20x20 (4 Adet/Paket)	36 Kum / 40 Kum	830.00 TL
200x32x20 (4 Adet/Paket)	36 Kum / 40 Kum	875.00 TL
250x25x25 (5 Adet/Paket)	36 Kum / 40 Kum	1093.00 TL
250x30x25 (4 Adet/Paket)	36 Kum / 40 Kum	1295.00 TL
250x32x25 (4 Adet/Paket)	36 Kum / 40 Kum	1357.00 TL
250x40x25 (2 Adet/Paket)	36 Kum / 40 Kum	1670.00 TL
300x30x30 (2 Adet/Paket)	36 Kum / 40 Kum	2001.00 TL
300x32x30 (2 Adet/Paket)	36 Kum / 40 Kum	2183.00 TL
300x40x30 (2 Adet/Paket)	36 Kum / 40 Kum	2579.00 TL
350x40x40 (2 Adet/Paket)	36 Kum / 40 Kum	3662.00 TL
400x40x40 (1 Adet/Paket)	36 Kum / 40 Kum	4776.00 TL



NK



INOX



SC

Karbosan Taşlama Taşları (BOMBELİ)

115x6.4x22 NK A24 RS (25 Adet/Paket)	34.00 TL
125x6.4x22 NK A24 RS (25 Adet/Paket)	39.34 TL
180x6.4x22 NK A24 RS (10 Adet/Paket)	70.49 TL
180x8.0x22 NK A24 RS (10 Adet/Paket)	79.71 TL
180x10.0x22 NK A24 RS (10 Adet/Paket)	
230x6.4x22 NK A24 RS (10 Adet/Paket)	122.24 TL

115x6.4x22 INOX AA 24 (25 Adet/Paket)	
125x6.4x22 INOX AA 24 (25 Adet/Paket)	
180x6.4x22 INOX AA 24 (10 Adet/Paket)	
180x8.0x22 INOX AA 24 (10 Adet/Paket)	
230x6.4x22 INOX AA 24 (10 Adet/Paket)	

115x6.4x22 SC C24 S (25 Adet/Paket)	39.99 TL
180x6.4x22 SC C24 S (10 Adet/Paket)	
180x8.0x22 SC C24 S (10 Adet/Paket)	102.66 TL
230x6.4x22 SC C24 S (10 Adet/Paket)	

Karbosan SCG Elmas Bileme Taşları

125x20x20 (5 Adet/Paket)	314.00 TL
150x20x20 (5 Adet/Paket)	375.00 TL
150x25x20 (5 Adet/Paket)	458.00 TL
175x20x20 (5 Adet/Paket)	494.00 TL
175x25x20 (5 Adet/Paket)	563.00 TL
200x20x20 (5 Adet/Paket)	620.00 TL
200x25x20 (5 Adet/Paket)	727.00 TL
200x32x20 (5 Adet/Paket)	956.00 TL
250x25x25 (5 Adet/Paket)	1190.00 TL
250x32x25 (3 Adet/Paket)	429.00 TL
300x32x30 (2 Adet/Paket)	2282.00 TL



konik

düz

çanak

Karbosan SC Burçlu Mozaik Silme Taşları

100x50xM14 Konik	207.00 TL
125x50xM14 Konik	278.00 TL
100x50xM14 Düz	248.00 TL
125x50xM14 Düz	340.00 TL
110x58x22 Çanak - 16 Kum	260.00 TL

Karbosan NK Mozaik Silme Taşları

100x50x25	126.00 TL
100x50x50	218.00 TL
100x100x50	407.00 TL
200x100x50	803.00 TL



çanak



düz

Karbosan Çanak Taşları

D-50 Düz	EKR / EKW 46/60	161.00 TL
D-75 Düz	EKR / EKW 46/60	195.00 TL
D-100 Düz	EKR / EKW 46/60	243.00 TL
D-125 Düz	EKR / EKW 46/60	410.00 TL
D-150 Düz	EKR / EKW 46/60	666.00 TL
E-50 Konik	EKR / EKW 46/60	154.00 TL
E-75 Konik	EKR / EKW 46/60	161.00 TL
E-100 Konik	EKR / EKW 46/60	191.00 TL
E-125 Konik	EKR / EKW 46/60	269.00 TL
E-150 Konik	EKR / EKW 46/60	358.00 TL

Karbosan Testere Taşları

150x6.0x20 NK	60 / 80 Kum	182.00 TL
150x8.0x20 NK	60 / 80 Kum	194.00 TL
150x10.0x20 NK	60 / 80 Kum	216.00 TL
175x8.0x20 NK	60 / 80 Kum	207.00 TL
175x10.0x20 NK	60 / 80 Kum	231.00 TL
200x8.0x20 NK	60 / 80 Kum	242.00 TL
200x10.0x20 NK	60 / 80 Kum	280.00 TL
250x10.0x25 NK	60 / 80 Kum	431.00 TL

175x8.0x20 EKR	60 / 80 Kum	230.00 TL
175x10.0x20 EKR	60 / 80 Kum	257.00 TL
200x8.0x20 EKR	60 / 80 Kum	279.00 TL
200x10.0x20 EKR	60 / 80 Kum	318.00 TL
250x10.0x25 EKR	60 / 80 Kum	510.00 TL

Karbosan Flap Disk Zımparalar

	40 Kum	60 Kum	80 Kum
115x22 NK	41.58 TL	40.37 TL	39.36 TL
125x22 NK			
180x22 NK	99.40 TL	91.97 TL	97.97 TL
115x22 ZR	49.42 TL	46.65 TL	46.65 TL
125x22 ZR			
180x22 ZR	120.98 TL	116.43 TL	110.61 TL

Karbosan Fiber Disk Zımpara

115 mm, NK 36-40-50 kum	13.66 TL
115 mm, NK 60-80 üzeri kum	11.76 TL
180 mm, NK 36-40-50 kum	31.61 TL
180 mm, NK 60-80 üzeri kum	27.22 TL

Karbosan Fiber Disk Zımpara

180 mm, SC 36-40-50 kum	33.29 TL
180 mm, SC 60-80 üzeri kum	29.96 TL

Sabun Taşı 150x50x25 mm

Beyaz	16.50 €
Turuncu	16.50 €

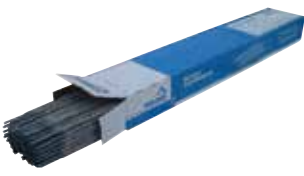

KAYNAK ELEKTRODLARI

CİNSİ	ÇAPxBOY	FİYATI	ADET	PAKET FİYATI
Oerlikon Overcord - S	2.50x350 mm		100	
Oerlikon Overcord - S	3.25x350 mm		100	
Oerlikon Overcord - S	4.00x350 mm		100	
Oerlikon Overcord Zet	2.50x350 mm		115	
Oerlikon Overcord Zet	3.25x350 mm		90	
Oerlikon Overcord Zet	4.00x350 mm		115	
Magmaweld ESR 13 (Rutil)	2.00 x 300 mm	2.010 TL	170	
Magmaweld ESR 13 (Rutil)	2.50 x 350 mm	1.830 TL	100	
Magmaweld ESR 13 (Rutil)	3.25 x 350 mm	2.430 TL	100	
Magmaweld ESR 13 (Rutil)	4.00 x 350 mm	3.950 TL	100	
Magmaweld ESR 13 (Rutil)	4.00 x 450 mm	5.770 TL	100	
Magmaweld ESB 48 (Bazik)	2.50 x 350 mm	1.790 TL	90	
Magmaweld ESB 48 (Bazik)	3.25 x 350 mm	2.470 TL	90	
Magmaweld ESB 48 (Bazik)	4.00 x 450 mm	4.920 TL	90	
Oerlikon Tenacito	2.50x350 mm		130	
Oerlikon Tenacito	3.25x350 mm		90	
Oerlikon Tenacito	4.00x350 mm		100	
Oerlikon Inox AWL	2.00x300 mm		125	
Oerlikon Inox AWL	2.50x300 mm		80	
Oerlikon Inox AWL	3.25x350 mm		60	
Magmaweld EI 308 L	2.00 x 300 mm	5.470 TL	125	
Magmaweld EI 308 L	2.50 x 300 mm	8.400 TL	80	
Magmaweld EI 308 L	3.25 x 300 mm	12.750 TL	60	
Magmaweld EI 308 L	3.25 x 350 mm	14.770 TL	60	
Oerlikon Citodur 600/B	2.50x350 mm		180	
Oerlikon Citodur 600/B	3.25x350 mm		100	
Oerlikon Citodur 600/B	4.00x450 mm		100	
Magmaweld EH 360 B	2.50x350 mm		5 KG	
Magmaweld EH 360 B	3.25x350 mm		5 KG	
Magmaweld EH 360 B	4.00x450 mm		6.5 KG	
Oerlikon Superfonte Ni	2.50x300 mm		50	
Oerlikon Superfonte Ni	3.25x300 mm		25	
Magmaweld ENI 402 Ni	2.50x300 mm	39.78 TL	50	
Magmaweld ENI 402 Ni	3.25x300 mm	72.35 TL	25	
Oerlikon Superfonte MO	2.50x300 mm		50	
Oerlikon Superfonte MO	3.25x300 mm		25	
Magmaweld ENI 406 MO	2.50x300 mm	36.17 TL	50	
Magmaweld ENI 406 MO	3.25x300 mm	64.33 TL	25	

PASLANMAZ ALUMİNYUM GAZALTI VE TIG KAYNAK TELLERİ



Magmaweld MI 308 LSI	0.8 mm	13.000 \$ / kg	15 kg / Paket
Magmaweld MI 308 LSI	1.0 mm	12.500 \$ / kg	15 kg / Paket
Magmaweld MI 308 LSI	1.2 mm	12.560 \$ / kg	15 kg / Paket

Magmaweld MI 316 LSI	0.8 mm	16.130 \$ / kg	15 kg / Paket
Magmaweld MI 316 LSI	1.0 mm	15.690 \$ / kg	15 kg / Paket
Magmaweld MI 316 LSI	1.2 mm	15.630 \$ / kg	15 kg / Paket

Magmaweld TI 308 L	1.2 mm	8.750 \$ / kg	5 kg / Paket
Magmaweld TI 308 L	1.6 mm	7.940 \$ / kg	5 kg / Paket (Plastik)
Magmaweld TI 308 L	2.0 mm	7.560 \$ / kg	5 kg / Paket (Plastik)
Magmaweld TI 308 L	2.4 mm	7.500 \$ / kg	5 kg / Paket (Plastik)
Magmaweld TI 308 L	3.2 mm	6.880 \$ / kg	5 kg / Paket

Magmaweld TI 316 L	1.2 mm	11.880 \$ / kg	5 kg / Paket
Magmaweld TI 316 L	1.6 mm	11.690 \$ / kg	5 kg / Paket
Magmaweld TI 316 L	2.0 mm	11.310 \$ / kg	5 kg / Paket
Magmaweld TI 316 L	2.4 mm	11.250 \$ / kg	5 kg / Paket
Magmaweld TI 316 L	3.2 mm	11.250 \$ / kg	5 kg / Paket

magmaweld™

ALUMİNYUM GAZALTI TELİ AISİ5

Magmaweld MAL 4043	0.8 mm	12.380 \$ / kg	7 kg / Paket
Magmaweld MAL 4043	1.0 mm	11.810 \$ / kg	7 kg / Paket
Magmaweld MAL 4043	1.2 mm	11.630 \$ / kg	7 kg / Paket

ALUMİNYUM GAZALTI TELİ AIMg5

Magmaweld MAL 5356	0.8 mm	12.630 \$ / kg	7 kg / Paket
Magmaweld MAL 5356	1.0 mm	12.060 \$ / kg	7 kg / Paket
Magmaweld MAL 5356	1.2 mm	11.880 \$ / kg	7 kg / Paket

ALUMİNYUM TİG TELİ AIMg5

Magmaweld TAL 5356	2.4 mm	11.88 \$ / kg	2.5 kg / Paket
Magmaweld TAL 5356	3.2 mm	11.88 \$ / kg	2.5 kg / Paket



MAGMAWELD GAZALTI KAYNAK TELLERİ

magmaweld™

CİNSİ	ÇAP	FİYATI	KG
Magmaweld MG 2	0.8 mm	61.88 TL	15
Magmaweld MG 2	1.0 mm	60.21 TL	15
Magmaweld MG 2	1.2 mm	59.38 TL	15
Magmaweld MG 2	0.8 mm	68.11 TL	60
Magmaweld MG 2	1.0 mm	66.44 TL	60
Magmaweld MG 2	1.2 mm	65.61 TL	60
Magmaweld MG 2	0.8 mm	63.53 TL	250
Magmaweld MG 2	1.0 mm	61.95 TL	250
Magmaweld MG 2	1.2 mm	61.05 TL	250



Magmaweld TİG Telleri

Magmaweld TG 2	1.6 X 1000 mm	79.73 TL / kg
Magmaweld TG 2	2.0 X 1000 mm	75.57 TL / kg
Magmaweld TG 2	2.4 X 1000 mm	71.41 TL / kg
Magmaweld TG 2	3.2 X 1000 mm	71.41 TL / kg

SG2 GAZALTI KAYNAK TELLERİ

SG 2	0.8 mm	1.6982 \$
SG 2	1.0 mm	1.5837 \$
SG 2	1.2 mm	1.5141 \$



**MAGMAWELD ID 250 MK ECO**

Şebeke Gerilimi (3 Faz) : 400 V
Kaynak Akım Ayar Şası : 50-250 A
Açık Devre Gerilimi : 62 V
Koruma Sınıfı : IP23

1 350.- \$

**MAGMAWELD ID 350 M ECO**

Şebeke Gerilimi (3 Faz) : 400 V
Şebekeden Çekilen Güç : 18.5 (%40) kVA
Kaynak Akım Ayar Şası : 50-350 A
Açık Devre Gerilimi : 62 V
Koruma Sınıfı : IP23

1 700.- \$

MAGMAWELD ID 350 MK ECO

Şebeke Gerilimi (3 Faz) : 400 V
Şebekeden Çekilen Güç : 18.5 (%40) kVA
Kaynak Akım Ayar Şası : 50-350 A
Anma Kaynak Gerilimi : 350 ADC (%33) A
Açık Devre Gerilimi : 62 V
Gerilim Ayarı Kdeme Sayısı : 3x7
Koruma Sınıfı : IP23

1 481.- \$

MAGMAWELD ID 500 M

Şebeke Gerilimi (3 Faz) : 400 V
Kaynak Akım Ayar Şası : 50-500 A
Anma Kaynak akımı : 500 (%45) A
Ağırlık : 105.75 Kg
Koruma Sınıfı : IP23
Kaynak Teli Çapı : 0.80 - 2.40 mm

2 163.- \$

MAGMAWELD ID 350 MKW ECO

Şebeke Gerilimi (3 Faz) : 400 V
Şebekeden Çekilen Güç : 18.5 (%40) kVA
Kaynak Akım Ayar Şası : 50-350 A
Anma Kaynak Gerilimi : 350 ADC (%33) A
Açık Devre Gerilimi : 62 V
Koruma Sınıfı : IP23

1 863.- \$

**Magmaweld Kaynak Spreyi**
400 gr

4.25 \$

**Magmaweld Kaynak Pastası**
300 gr

3.90 \$

**Solarmatik Kaynak Maskesi**
MKM 620 S

38.125 \$

**Solarmatik Kaynak Maskesi**
MKM 620 MA

46.625 \$



MAGMAWELD ID 350 MW ECO 2 113.- \$

Şebeke Gerilimi (3 Faz) : 400 V
Şebekeden Çekilen Güç : 18.5 (%40) kVA
Kaynak Akım Ayar Shası : 50-350 A
Anma Kaynak Akımı : 350 (%40) A
Açık Devre Gerilimi : 62V
Ağırlık : 115.75 Kg
Koruma Sınıfı : IP23

MAGMAWELD ID 500 MW ECO 2 563.- \$

Şebeke Gerilimi (3 Faz) : 400 V
Şebekeden Çekilen Güç : 31.81 (%40) kVA
Kaynak Akım Ayar Shası : 50-500 A
Anma Kaynak Akımı : 500 (%40) A
Açık Devre Gerilimi : 69V
Ağırlık : 122 Kg
Koruma Sınıfı : IP23



MAGMAWELD MONOMİG 200 IK 1069.- \$

Şebeke Gerilimi (1 Faz) : 230 V
Kaynak Akım Ayar Shası : 30-200 A
Kaynak Tel Çapı : 0.60-1.00 mm
Tel Sürme Hızı : 1-24 m/dk



MAGMAWELD MINISTICK 140 164.- \$

Şebeke Gerilimi (1 Faz) : 230 V
Elektrod Çapı : 2.00 - 3.25 mm
Ağırlık : 7.5 Kg
Koruma Sınıfı : IP23 S

MAGMAWELD MONOSTICK 165i 243.- \$

Şebeke Gerilimi (1 Faz) : 230 V
Elektrod Çapı : 1.60 - 3.25 mm
Ağırlık : 7.5 Kg
Koruma Sınıfı : IP23

MAGMAWELD MEGASTICK 200i 230.- \$

Şebeke Gerilimi (1 Faz) : 230 V
Elektrod Çapı : 1.60 - 4.00 mm
Ağırlık : 5 Kg
Koruma Sınıfı : IP23



MAGMAWELD MONOSTICK 200i 284.- \$

Şebeke Gerilimi (1 Faz) : 230 V
Elektrod Çapı : 1.60 - 4.00 mm
Ağırlık : 10.5 Kg
Koruma Sınıfı : IP23



MAGMAWELD MONOTİG 160i 669.- \$

Şebeke Gerilimi (1 Faz) : 230 V
Kaynak Akım Ayar Shası : 10-160 A
Elektrod Çapı : 1.60 - 3.25 mm
Tungsten Elektrod Çapı : 1.20 - 2.40 mm
Ağırlık : 9.5 Kg
Koruma Sınıfı : IP23

MAGMAWELD MONOTİG 200i 694.- \$

Şebeke Gerilimi (1 Faz) : 230 V
Kaynak Akım Ayar Shası : 5-200 A
Elektrod Çapı : 2.00 - 4.00 mm
Tungsten Elektrod Çapı : 1.00 - 2.40 mm
Ağırlık : 10 Kg
Koruma Sınıfı : IP23

MAGMAWELD MONOTİG 165ip 706.- \$

Şebeke Gerilimi (1 Faz) : 230 V
Kaynak Akım Ayar Shası : 30-160 A
Elektrod Çapı : 2.00 - 3.25 mm
Tungsten Elektrod Çapı : 1.00 - 2.40 mm
Ağırlık : 10 Kg
Koruma Sınıfı : IP23



**Paslanmaz Gazaltı Kaynak Teli
MIG 308 L - 15kg/paket**

0.8 mm	01008	14.82 \$
1.0 mm	01009	14.82 \$
1.2 mm	01010	14.82 \$

**Paslanmaz Gazaltı Kaynak Teli
MIG 316 L - 15kg/paket**

0.8 mm	01011	19.00 \$/kg
1.0 mm	01012	19.00 \$/kg
1.2 mm	01013	19.00 \$/kg



**Paslanmaz Gazaltı Kaynak Teli
TIG 308 L - 5kg/paket**

1.6 mm x 1000mm	01014	13.30 \$
2.0 mm x 1000 mm	01015	13.30 \$
2.4 mm x 1000 mm	01016	13.30 \$
3.2 mm x 1000 mm	01017	13.30 \$

**Paslanmaz Gazaltı Kaynak Teli
TIG 316 L - 5kg/paket**

1.6 mm x 1000mm	01018	17.48 \$
2.0 mm x 1000 mm	01019	17.48 \$
2.4 mm x 1000 mm	01020	17.48 \$
3.2 mm x 1000 mm	01021	17.48 \$



**Alüminyum Gazaltı Kaynak Teli
MIG - 7.5 kg/paket**

ALSI5 - 1.0 mm	13.57 \$/kg
ALMG5 - 1.0 mm	13.83 \$/kg
ALMG5 - 1.2 mm	13.57 \$/kg

**Alüminyum Gazaltı Kaynak Teli
TIG - 5 kg/paket**

ALSI5 - 2.4 mm	11.63 \$/kg
ALMG5 - 2.4 mm	11.63 \$/kg



TIG Torç Arka Kapakları

41V33 Kısa, 5/16-24 UNF dış	27391	0.45 \$
41V35 Orta, 5/16-24 UNF dış	27392	0.50 \$
41V24 Uzun, 150mm, 5/16-24 UNF	27393	0.75 \$
41V24L Uzun, 175mm, 5/16-24 UNF	27394	0.95 \$
57Y04 Kısa, 3/8-32 UNF dış	27297	0.45 \$
57Y03 Orta, 3/8-32 UNF dış	27296	0.50 \$
57Y02 Uzun, 150mm, 3/8-32 UNF dış	27298	0.75 \$
57Y01 Uzun, 175mm, 3/8-32 UNF dış	27299	0.95 \$



TIG Welding Torç

SR 27V Torç usluklu ve Şalterli	27324	65.- \$
WP26 Torç Şalterli	27325	65.- \$
SR26VF Oynar Kafa Torç	27326	65.- \$



Seramik Nozullar

6 mm, 10N50, No:4	27350	0.40 \$
8 mm, 10N49, No:5	27351	0.40 \$
10 mm, 10N48, No:6	27352	0.40 \$
11 mm, 10N47, No:7	27353	0.40 \$
13 mm, 10N46, No:8	27355	0.40 \$
16 mm, 10N45, No:10	27354	0.40 \$
19 mm, 10N44, No:12	27356	0.40 \$

Collet

1.6 mm	27361	0.40 \$
2.0 mm	27362	0.40 \$
2.4 mm	27363	0.40 \$
3.2 mm	27364	0.40 \$



Collet Body

1.6 mm	27366	0.85 \$
2.0 mm	27367	0.85 \$
2.4 mm	27368	0.85 \$
3.2 mm	27369	0.85 \$

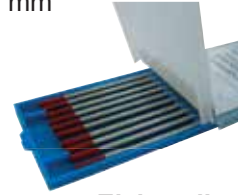

Tungsten Elektrodlar

Kırmızı Uçlu, paslanmaz çelik kaynak için

1.6x175 mm	27371	2.00 \$
2.0x175 mm	27372	2.60 \$
2.4x175 mm	27373	3.30 \$
3.2x175 mm	27374	5.75 \$

Tungsten Elektrodlar

Yeşil Uçlu,

1.6x175 mm	2.65 \$
2.0x175 mm	2.95 \$
2.4x175 mm	4.15 \$
3.2x175 mm	7.30 \$

Tungsten Elektrodlar

Sarı Uçlu, WZ8, ZrO2 %0.7 - %0.9

1.6x175 mm	27386	5.05 \$
2.0x175 mm	27387	8.15 \$
2.4x175 mm	27388	10.00 \$
3.2x175 mm	27389	18.65 \$



Oetiker Kelepçeler

Kaynak makinaları, torç ve sanayide kullanılır.

8.7 x 5.5 mm	100 Adet/paket	0.90 € / Adet
9.5 x 5.5 mm	100 Adet/paket	0.92 € / Adet
10.5 x 5.5 mm	100 Adet/paket	1.10 € / Adet
11.0 x 5.5 mm	100 Adet/paket	1.20 € / Adet
12.8 x 8.0 mm	100 Adet/pake	1.35 € / Adet
13.3 x 8.0 mm	100 Adet/paket	1.90 € / Adet



MIG/MAG Kaynak Torçları

MB 15 AK 180 Amper, 4 metre	27311	72.- \$
Gaz Soğut. binzel tip bütün makaralara uyar		
MB 25 AK 250 Amper, 4 metre	27312	82.- \$
Gaz Soğut. binzel tip bütün makaralara uyar		
MB 36 KD 360 Amper, 4 metre	27313	87.- \$
Gaz Soğut. binzel tip bütün makaralara uyar		
500 Amper Su Soğutmalı, 4 metre		113.- \$



MIG/MAG Kaynak Torç Boynu

MB 15 AK	27305	6.50 \$
MB 25 AK	27306	10.20 \$
MB 36 AK	27307	14.00 \$



Kontakt Memeler (Gazaltı Kaynak Torçları için)

M6 x 25 mm Ø 6 mm, 0.8 mm ECu	27598	0.50 \$
M6 x 28 mm Ø 6 mm, 0.8 mm ECu	27601	0.50 \$
M6 x 28 mm Ø 6 mm, 1.0 mm ECu	27602	0.50 \$
M6 x 28 mm Ø 6 mm, 1.2 mm ECu	27603	0.50 \$
M6 x 28 mm Ø 6 mm, 1.6 mm ECu	27604	0.50 \$



M6 x 28 mm Ø 8 mm, 0.8 mm ECu	27607	0.55 \$
M6 x 28 mm Ø 8 mm, 1.0 mm ECu	27608	0.55 \$
M6 x 28 mm Ø 8 mm, 1.2 mm ECu	27609	0.55 \$
M6 x 28 mm Ø 8 mm, 1.6 mm ECu	27610	0.55 \$
M6 x 28 mm Ø 8 mm, 0.8 mm CrzCu	27647	0.55 \$
M6 x 28 mm Ø 8 mm, 1.0 mm CrzCu	27648	0.55 \$



M8 x 30 mm Ø 8 mm, 0.8 mm ECu	27613	0.63 \$
M8 x 30 mm Ø 8 mm, 1.0 mm ECu	27614	0.63 \$
M8 x 30 mm Ø 8 mm, 1.2 mm ECu	27615	0.63 \$
M8 x 30 mm Ø 8 mm, 1.6 mm ECu	27616	0.63 \$



M8 x 30 mm Ø 10 mm, 0.8 mm ECu	27618	0.65 \$
M8 x 30 mm Ø 10 mm, 1.0 mm ECu	27619	0.65 \$
M8 x 30 mm Ø 10 mm, 1.2 mm ECu	27620	0.65 \$
M8 x 30 mm Ø 10 mm, 1.6 mm ECu	27621	0.65 \$
M8 x 30 mm Ø 10 mm, 1.2 mm CrZrCu	27668	0.65 \$



M8 x 38 mm Ø 6 mm, 0.8 mm ECu	27624	0.63 \$
M8 x 38 mm Ø 6 mm, 1.0 mm ECu	27625	0.63 \$
M8 x 38 mm Ø 6 mm, 1.2 mm ECu	27626	0.63 \$



Kontakt Meme Tutucu 36 KD-M6	27671	0.52 \$
Kontakt Meme Tutucu 36 KD-M8	27672	0.52 \$



Kontakt Meme Tutucu 24 KD-M6	27677	0.45 \$
------------------------------	-------	---------



Kontakt Meme Tutucu 25 AK-M6	27680	0.55 \$
------------------------------	-------	---------



Kontakt Meme Tutucu 15 AK-M6	27685	1.00 \$
------------------------------	-------	---------



Kontakt Meme Tutucu 501D-M8	27690	0.60 \$
-----------------------------	-------	---------



Teflon Gaz Difüzör (Dişli) 501D	27695	0.20 \$
---------------------------------	-------	---------



Teflon Gaz Difüzör (Dişsiz) 36KD	27697	0.20 \$
----------------------------------	-------	---------



Teflon Gaz Difüzör (Dişsiz) 40KD	27699	0.20 \$
----------------------------------	-------	---------



Teflon Gaz Difüzör (Dişsiz) 24KD	27701	0.18 \$
----------------------------------	-------	---------



Gaz Nozulları

Ø 18 mm (dişsiz) iç çap 12 mm MB 15	27711	2.58 \$
-------------------------------------	-------	---------



24 KD



25 AK

Ø 22 mm (dişsiz) 24 KD	27712	3.28 \$
Ø 22 mm (dişsiz) 25 KD	27714	3.28 \$



22 mm



36 KD

Ø 22 mm (dişli)	27716	3.30 \$
Ø 24 mm (dişsiz) 36 KD	27718	3.50 \$



40 KD



501 D

Ø 26 mm (dişsiz) 40 KD	27720	3.28 \$
Ø 24 mm (dişsiz) 501 KD	27721	3.28 \$



Nozul Temizleme Aparatı	27360	2.- \$
-------------------------	-------	--------



Metal için Örtücü Boya Kalem

Feltip, penetrent keçeli kalem

Beyaz	27063	1.46 \$
Sarı	27064	1.46 \$
Yeşil	27065	1.46 \$
Mavi	27066	1.46 \$
Kırmızı	27067	1.46 \$
Siyah	27068	1.46 \$

Mermer Tebeşir

5x10x100 mm	27083	0.30 \$
10x10x100 mm	27084	0.30 \$

TC 10 Meme Temizleme İğnesi	27470	1.61 \$
Kaynakçı Çekici	26702	14.55 \$

Karbon Elektrod Pensesi	26801	92.30 \$
-------------------------	-------	----------

Kablo Kaynak Bağlantı Soketi		
10 - 25 Erkek	26960	1.80 \$
10 - 25 Dişi	26970	1.80 \$
35 - 70 Erkek	26962	3.45 \$
35 - 70 Dişi	26972	3.45 \$
50 - 70 Erkek	26965	3.85 \$
50 - 70 Dişi	26975	3.85 \$
70 - 95 Erkek	26967	6.60 \$
70 - 95 Dişi	26977	6.60 \$

Kaynak Makina Bağlantı Soketi		
10 - 25	26948	1.85 \$
35 - 70	26949	3.60 \$
50 - 70	26950	6.00 \$
70 - 95	26952	6.85 \$

Kaynak Kablosu		
16 mm ²	27424	165.00 TL
25 mm ²	27425	241.00 TL
35 mm ²	27426	330.00 TL
50 mm ²	27427	470.00 TL
70 mm ²	27428	670.00 TL

Akü Takviye Kablosu		
16 mm ²	27460	165.00 TL
25 mm ²	27461	241.00 TL
35 mm ²	27462	330.00 TL
50 mm ²	27463	470.00 TL
70 mm ²	27464	670.00 TL

Arkmatik Kaynak Maskesi

ZTH603 Kolormatik	MK0378	15.80 \$
ZYH605 Kolormatik Ayarlı	MK0379	17.15 \$
JUNIOR		20.- \$

Arkmatik maske camı için Koruyucu Şeffaf Panel		
115x 105 mm		1.00 \$
115x90 mm	26525	0.90 \$

Kaynak Baş Maskesi	26505	7.70 \$
Kaynak Maskesi		
Fiber Karton Kaynak Maskesi	26501	2.45 \$
Plastik Kaynak Maskesi	26502	2.15 \$

Maske Camı Geniş 110x80		
777 - Shade 10	26531	0.31 \$
787 - Shade 11	26532	0.40 \$
888 - Shade 13	26533	0.40 \$
Maske Camı		
777 - Shade 10	MK0380	0.35 \$
Maske Camı Şeffaf Dar, 110x50 mm	26530	0.12 \$
Maske Camı Şeffaf Geniş, 110x80 mm	26535	0.19 \$

Maske Camı Dar 110x50 mm		
777 - Shade 10		0.40 \$
787 - Shade 11		0.40 \$
888 - Shade 13		0.40 \$
Maske Camı Beyaz Dar, 110x50 mm		0.26 \$

Kaynak Elektrod Pensleri		
400A	26753	5.80 \$
500A	26755	6.20 \$
600A	26756	6.40 \$
300A	MK0370	2.95 \$
400A	MK0371	5.60 \$
500A	MK0372	5.60 \$
600A	MK0373	5.90 \$

Kaynak Elektrod Penseleri Hafif Tip		
300A italyan	26743	2.90 \$

Kaynak Şase Pensleri		
300A	26908	3.40 \$
500A	26910	5.20 \$
300A	MK0376	3.55 \$
500A	MK0377	5.40 \$
Kaynak Şase Pensesi		
300A	MES 509	4.18 \$

Gaz Regülatörleri (Gloor Model D tip)

Ø63mm-16 bar

Ø63mm-315 bar



680YE Oksijen Basınç Düşürücü Regülatörü

27131

2 555.- TL

Ø63mm-2,5 bar

Ø63mm-40 bar



681YE Asetilen Basınç Düşürücü Regülatörü

27132

2 555.- TL

Ø63mm-32 bar

Ø63mm-315 bar



684 Karbon Basınç Düşürücü Regülatörü

27133

2 485.- TL

Ø63mm-32 bar

Ø63mm-315 bar



682 Argon Basınç Düşürücü Regülatörü

27134

2 485.- TL

Ø63mm-25 bar

Ø63mm-315 bar



683YE Azot Basınç Düşürücü Regülatörü

27136

2 555.- TL



Elektrod Kurutma Fırınları

1 Paketlik, 50-200°C

27501

16 245.- TL

4 Paketlik, 50-300°C

27502

44 635.- TL

Asılı Elektrod Termosu

27511

10 890.- TL



011 Argon Regülatörü Flometreli

27137

3 220.- TL

013 Karbon Regülatörü Flometreli

27145

3 220.- TL



606 LPG Propan Basınç Düşürücü Manometreli

27140

1190.- TL



607 LPG Propan Basınç Düşürücü

27141

1050.- TL



Karbondioksit Tüp Isıtıcı

220 Volt

27442

1 850.00 TL



651 - Ara Nipeli CO2 (W21,80X1/14" - R5/8")

27154

392.00 TL



Regülatör Tüp Adaptör Somunları

1/2 - 3/4 Oksijen Somunu

27150

280.00 TL



Ara Redüksiyonu

3/4 Dişi - 1/2 Erkek Adaptör

27151

280.00 TL

1/2 Dişi - 3/4 Erkek Adaptör

27152

280.00 TL



650 - Ara Nipeli Argon - Azot (R5/8" - W21,80X1/14")

27153

378.00 TL

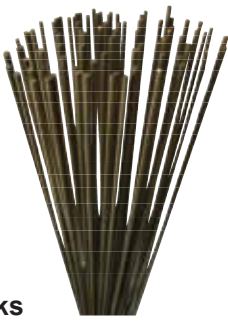

Boraks

1 Kg	27070	38.00 TL
25 Kg	27071	675.00 TL

Sert Lehim için Pirinç Kaynak Teli (kg fiyatı)

2 mm	27401	850.00 TL/kg
2.5 mm	27402	850.00 TL/kg
3 mm	27403	850.00 TL/kg
4 mm	27404	850.00 TL/kg



795 Hafif Kuyumcu Hamlacı

6 mm oksijen + propan bağlantı	27169	2 520.- TL
--------------------------------	-------	------------



796 Mini Kuyumcu Hamlacı

2 mm oksijen + propan bağlantı	27170	3 640.- TL
--------------------------------	-------	------------



813 Aygaz Tüp Adaptörü

Piknik tüp için	27251	210.- TL
-----------------	-------	----------



715 Lüle Karışimli Kesme Hamlacı	27270	4 550.- TL
----------------------------------	-------	------------



Lüle Karışimli Kesme Lülesi

240 - Oksijen Propan 3-6 mm	27474	385.00 TL
241 - Oksijen Propan 10-12 mm	27471	385.00 TL
242 - Oksijen Propan 10-75 mm	27472	385.00 TL
243 - Oksijen Propan 70-100 mm	27473	385.00 TL
244 - Oksijen Propan 90-150 mm	27475	385.00 TL
245 - Oksijen Propan 140-200 mm	27476	385.00 TL
246 - Oksijen Propan 190-300 mm	27477	385.00 TL



Alev Emniyet Valfi Basınç Düşürücü için

660 Oksijen	27280	805.00 TL
661 Asetilen	27282	805.00 TL



Alev Emniyet Valfi Basınç Düşürücü için

662 Propan		840.00 TL
------------	--	-----------



Alev Emniyet Valfi Hamlacı için

748 Oksijen	27284	525.00 TL
749 Asetilen	27286	525.00 TL



Alev Emniyet Valfi Hortum Arası için

663 Oksijen		470.00 TL
664 Asetilen		470.00 TL



Oksi Gaz Kesme Hamlacı Takımı Arabasız

743 Propan	27160	4 210.- TL
757 Asetilen	27161	4 640.- TL



741 Kesme Hamlacı

27181	2 205.00 TL
-------	-------------

Oksijen-Propan



740 Elçek Sap (Tutamak)

27171	1 490.00 TL
-------	-------------

740-02 Elçek Sap (Tutamak) için

200.00 TL

740-05-02 Elçek Sap (Tutamak)

545.00 TL

İçin Sap Volan Takımı



Kesme Lülesi Takım

755 Oksijen-Propan	27191	510.00 TL
765 Oksijen-Asetilen	27192	945.00 TL



Kesme Lülesi

752 Oksijen-Propan	27193	112.00 TL
753 Oksijen-Propan	27194	112.00 TL
754 Oksijen-Propan	27195	112.00 TL



751 Kesme Lülesi

27196	175.00 TL
-------	-----------

Bakır Kovan

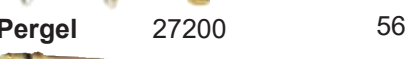

730 Araba Pergel

27200	560.00 TL
-------	-----------



Kaynak Kolları

820 No:0 - 0.2 - 0.5 mm	27210	735.00 TL
821 No:1 - 0.5 - 1 mm	27211	735.00 TL
822 No:2 - 1 - 2 mm	27212	750.00 TL
823 No:3 - 2 - 4 mm	27213	750.00 TL
824 No:4 - 4 - 6 mm	27214	770.00 TL
825 No:5 - 6 - 9 mm	27215	895.00 TL
826 No:6 - 9 - 14 mm	27216	910.00 TL
827 No:7 - 14 - 20 mm	27217	1120.00 TL
828 No:8 - 20 - 30 mm	27218	1190.00 TL



Kaynak Kesme Takımları

790 6'lı	27167	12 600.- TL
791 8'li	27168	15 400.- TL



Propan Tavlama Başlık

805 - 20 mm, M20x1	84881	420.00 TL
806 - 25 mm, M20x1	84882	420.00 TL
807 - 30 mm, M20x1	84883	435.00 TL
808 - 36 mm, M20x1	84884	435.00 TL
809 - 45 mm, M20x1	84885	455.00 TL
810 - 57 mm, M20x1	84886	455.00 TL



Tetikli Propan Tutamak

560 - 13 mm, M20x1, 8 mm	84921	1205.00 TL
561 - 20 mm, M20x1, 8 mm	84922	1400.00 TL
562 - 33 mm, M20x1, 8 mm	84923	1540.00 TL
563 - 45 mm, M20x1, 8 mm	84924	1750.00 TL
564 - 75 mm, M20x1, 8 mm	84925	1890.00 TL



Propan Tavlama Boyunları

800 - 10 mm, R3/8" - M20x1	84901	350.00 TL
801 - 20 mm, R3/8" - M20x1	84902	385.00 TL
802 - 30 mm, R3/8" - M20x1	84903	435.00 TL
803 - 40 mm, R3/8" - M20x1	84904	470.00 TL
804 - 50 mm, R3/8" - M20x1	84905	525.00 TL



799 Propan Tutamak

R3/8 gaz, 8 mm hortum bağlantı	84911	540.00 TL
--------------------------------	-------	-----------



Propan Tutamak, Sabit Boyunlu

840 - 10 mm, M20x1, 8 mm	84931	715.00 TL
841 - 20 mm, M20x1, 8 mm	84932	840.00 TL
842 - 30 mm, M20x1, 8 mm	84933	868.00 TL
843 - 40 mm, M20x1, 8 mm	84934	925.00 TL
844 - 50 mm, M20x1, 8 mm	84935	1010.00 TL



Tavlama Takımı

300 - 25 mm	27246	1295.00 TL
301 - 30 mm	27247	1295.00 TL
302 - 36 mm	27248	1310.00 TL
303 - 45 mm	27249	1310.00 TL



Eltos Tetikli Şalumo

33 cm	EST033	1380.- TL
45 cm	EST045	1518.- TL
75 cm	EST075	1645.- TL

Tetikli Şalumo

45 cm	865.- TL
75 cm	900.- TL



Eltos Pürmüz Poşetli

Aygaz	EP350	380.00 TL
İpragaz	EP351	403.00 TL

Pürmüz Aygaz

27135	6.50 \$
-------	---------



306 Üçlü Kaynak Takımı

27165	3 725.00 TL
-------	-------------

asetilen elçek sap, kaynak kolu no:1, no:2, no:3



Tavlama Kolu

865 - No: H3	27273	2 520.00 TL
866 - No: H4	27274	3 290.00 TL
867 - No: H5	27275	3 500.00 TL



Tavlama Lülesi

885 - No: 3	1 365.00 TL
886 - No: 4	2 100.00 TL
887 - No: 5	2 380.00 TL



304 Propan Havyalı Hamlaç Takımı

27260	1 960.00 TL
-------	-------------



305 Yedek Havya Bakırı

27261	980.00 TL
-------	-----------



Oksijen Hortumları

Hava dağıtımı ve oksijen - asetilen kaynağında kullanılan hortumlar PVK + Nbr özel formülasyonu ile elastikli ve sağlam olarak üretilmiştir. Yüksek mukavemetli sentetik ipe iç basınca dayanımı artırılmıştır.

8 mm 20 bar, kırmızı
8 mm 20 bar, mavi

6 mm 20 bar, kırmızı
6 mm 20 bar, mavi

10 mm 20 bar, kırmızı
10 mm 20 bar, mavi



Kaynak Hortumu

8 mm, 5/16, Çiftli

Düz LPG TSE

LPG tesisatlarında kullanılır.

8 mm
10 mm

Sanayi Hortumları fiyatları için sayfa 76'ya bakınız



Sedef Gazaltı Kaynak Nozul Pastası

200 gr

27011

2.35 \$

Koli Adedi : 18



SELOX Paslanmaz Kaynak Temizleme Jeli

2 kg ambalaj

8.70 \$ / Bidon

Koli Adedi : 8

Jel halindedir, fırça yardımıyla kullanılır. Paslanmaz çelik yüzeyindeki kaynak, ısıtma işlemi ve her türlü korozyon ve pas lekelerini temizler. AISI 304 -316- 321 ve türevleri için uygundur.

Daha çok ıslatma kabiliyeti, Daha az reaksiyon zamanı, Daha kuvvetli dağlama, Daha geç kuruma süresi vardır. İçerisinde tuz asidi olmadığından sonradan metal üzerinde sararma yapmadan homojen bir renk verir ve pas oluşumuna neden olmaz. Kolayca yıkanabilme özelliği vardır. Reaksiyon Süresi (20°C de - soğuk çekim) 15 – 60 dakikadır.

Uygulama : Yüzeydeki yağları FRD Yüzey Temizleme Jeli ile temizleyin. Kapağı açmadan homojen oluncaya kadar çalkalayın. Uygun bir fırça ile sürün. Reaksiyon süresi sonunda akan, bol, temiz su ile yıkayın.

SELOX Extra Paslanmaz Kaynak Temizleme Jeli

AISI 904L -SAF2507 ve türevleri olan paslanmaz çelikler için uygundur.



Blue Welding

Gazaltı Kaynak Çapak Önleme Sıvısı

30 kg

117.00 \$ / Bidon

Kokusuz blue welding gaz altı kaynak sıvısı elde taşınabilir sprey kabına doldurularak kaynak yaparken geçici korozyon önleyici ve doğal temizleme etkisiyle pratik kullanımlıdır. Kuru ve ıslak yüzeye kaynak nozulu ve kaynak ekipmanlarına çapak yapışmasını engeller. Parlayıcı değildir, silikon ve çözücü içermez.

Kaynaktan sonra kaplama veya cilalamada herhangi bir problem oluşturmaz.

Kullanımı ekonomiktir- yeterli koruyucu film tabakası oluşturur. İçerisindeki çevreye zararlı yüzey aktif madde yoktur. Doğada çözünebilir.

Uygulama : Kaynak bölgesinin her iki yanına ve/ veya torcun içine 25-30 cm mesafeden, çok ince bir tabaka oluşturacak şekilde spreylenir veya fırça ile sürülür kaynak işlemine geçilir.



RP - 100 Pasivasyon Sıvısı (SR-100)

132.- \$ / Bidon

Paslanmaz çeliklerin yüzeyi, korozyona karşı, mikroskobik incelikte koruyucu bir tabaka ile kaplıdır. Bu tabakaya pasif tabaka denir. Pasif tabaka, homojen, geçirimsiz ve koruyucudur. Pasif tabaka, pickling kimyasalları (TSK Kaynak temizleme Jeli, SPL Kaynak ve Yüzey Sprey Jeli, CERINOX Asit Banyosu) ile temizlenmiş ve metalik parlaklığa ulaşmış yüzeylerde oluşur. Yüzeydeki en küçük bir kirlilik, bu tabakanın oluşumunu engeller. Pickling işleminden sonra RP Pasivasyon çözeltisi, bu tabakanın oluşumunu çok 30 dakikada gerçekleştirir.

Uygulama : Pasivasyon sıvısı, fırça, daldırma veya spreyleme ile yüzeye uygulanır. Uygulanacak yüzey, temizlenmiş ve metalik parlaklığa ulaşmış olmalıdır. Reaksiyon sonunda yüzey, temiz ve basınçlı su ile yıkanır.



FRD - 100 Yüzey Temizleme Sıvısı (SRD-100)

30 kg

132.- \$ / Bidon

Paslanmaz çelik ve diğer tüm demir dışı metal (alüminyum, bakır vb.) yüzeylerin temizlenmesinde kullanılır. Her türlü çalışma kirliliğini, yağ ve gres lekelerini, çok hafif karıncalanma ve pasları temizler. Temiz ve parlak bir yüzey elde edilir. Yüzeydeki kaynak ve punta lekeleri önceden TSK Kaynak Temizleme Jeli ile temizlenmelidir. Reaksiyon Süresi : 15 - 60 dakikadır.

Uygulama : Yüzeye fırça ile sürülür veya spreylenir. Reaksiyon süresi sonunda bol basınçlı (100 -150 bar) su ile yıkanır.



SPK - 100 Paslanmaz Çelik Temizleme Sprey Sıvısı (W-3000)

25 kg

146.- \$ / Bidon

Paslanmaz çelik yüzeyindeki kaynak, ısıtma işlem lekelerini, oksitlenmeleri, karıncalanmaları, hafif kir ve yağları tek bir işlemde temizler ve yüzeyi pasivasyona hazırlar. AISI 304 -316- 321 ve türevleri için uygundur. Gözle görülür kolay bir spreyleme işlemi, Min zehirli gaz emisyonu ve nitrit ürünleri, Homojen ve parlak bir yüzey sağlar. Reaksiyon Süresi : (20°C de - soğuk çekim) 45 – 90 dakika Uygulama : Yüzeydeki yoğun kir ve yağları FRD Yüzey Temizleme Jeli ile temizleyin. Bidon muhteviyatını, homojen oluncaya kadar karıştırın. Mor renkli tozu bidona boşaltın ve iyice karıştırın. 10 Dakika bekletin. Karışımı, yüzeye el spreyi veya basınçlı hava pompası ile spreyleyin. Reaksiyon süresi sonunda 100 –150 bar basınçlı temiz su ile yıkayın. Kendi halinde kurumaya bırakın. El sürmeyin. Dikkat: Güneş ışığı altında uygulamayın. Uygularken gözlük, eldiven, önlük vb. malzeme kullanın. Cilt ile temasta bol su ile yıkayın. İdeal uygulama ortam sıcaklığı 15-20°C . Soğukta süreyi uzatın.

SPK - 100 Extra Paslanmaz Çelik Temizleme Sprey Sıvısı

.- TL/Bidon

AISI 904L -SAF2507 ve türevleri olan paslanmaz çelikler için uygundur.



SEROX Inox Temizleyici

CEROX Inox cleaner , mat ve polisajlı yüzeyleri temizlemek ve parlatmak için kullanılır.

Parmak izini temizler ve tekrar oluşumunu engeller. Solvent ve silikon içermez su bazlıdır. Yüzeydeki yazı, etiket ve resimleri bozmaz.

Alüminyum, bakır, sarı ve plastik yüzeylerde de kullanılır. AB nomlarına uygundur.

Gıda makinelerinde, otel, hastane vb. yerlerdeki mutfak ekipmanlarında, havuzlarda, asansörlerde, temizlik ve koruma amacıyla kullanılır.



SEROX Super Cleaner

Cerox süper cleaner kaynak makinası ile pickling işlemini gerçekleştirmek için kullanılan bir sıvıdır. Paslanmaz çelik yüzeyindeki kaynak, ısı işlem ve her türlü korozyon ve pas lekelerini temizler. Minimum gaz emisyonu, Homojen parlak yüzey , Zaman tasarrufu sağlar.



Best GK 2000 Gazaltı Kaynak Sprey

400 ml

98.00 TL



Çatlak Tespit Spreyleri

BT 69 Cleaner Sprey	27021	9.10 €
500 ml, Koli Adedi : 24		
BT 68 Penetrant Sprey	27022	10.00 €
500 ml, Koli Adedi : 24		
BT 70 Developer Sprey	27023	9.10 €
500 ml, Koli Adedi : 24		



RM 100 Seyyar Mikroskop 81960 166.- TL
100 kez büyütür, kaynak dikişlerinin, tekstil dokuma ve baskı işlerinin kontrolünde kullanılır.

Pro MIG Pickling Sprey

.- TL/Bidon

Paslanmaz çelik yüzeyindeki MIG-MAG kaynak, ısı işlem lekelerini, oksitlenmeleri, karıncalanmaları, hafif kir ve yağları tek bir işlemde temizler ve yüzeyi pasivasyona hazırlar. AISI 904L-SAF2507ve türevleri için uygundur. Gözle görülür kolay bir spreyleme işlemi, Min zehirli gaz emisyonu ve nitrit ürünleri, Homojen ve parlak bir yüzey. sağlar.

Reaksiyon Süresi : (20°C de - soğuk çekim) 300 dakika
Uygulama : Yüzeydeki yoğun kir ve yağları FRD Yüzey Temizleme Jeli ile temizleyin. Bidon muhteviyatını, homojen oluncaya kadar karıştırın. Mor renkli tozu bidona boşaltın ve iyice karıştırın. 10 Dakika bekletin. Karışımı, yüzeye el spreyi veya basınçlı hava pompası ile spreyleyin. Reaksiyon süresi sonunda 100 –150 bar basınçlı temiz su ile yıkayın. Kendi halinde kurumaya bırakın. El sürmeyin.



Cerinox T 100 Pickling Bath

25 kg

57.- \$/ Bidon

Asit banyosu , paslanmaz malzemenin üzerindeki her türlü oksidasyonu, karıncalanmaları, ağır pas ve kaynak lekelerini temizler ve yüzeyi pasive eder. Özel katkı maddeleri ile kuvvetlendirilerek ana metal kaybı en az seviyede tutulmuştur. Yüzeyi bozmaz ve sarartmaz. Yüzeye, gümüş rengi, kalıcı, homojen bir renk verir. Yüzeyi pasifleştirerek ileride oluşabilecek paslanma ve karıncalanmaları önler. Reaksiyon Süresi : AISI 304, 304L vb için 30 - 60 dakika; AISI 316, 321 ve vb için 60 - 90 dakikadır.

Uygulama : Asit Banyosu , akıcı bir sıvı olduğundan yüzeye sürülmez. Malzeme üzerindeki ağır yağ, uygun bir kimyasalla temizlenir. Aside dayanıklı plastik bir kap içine konan parçaların üzerine Asit Banyosu konur. Kirlilik, malzeme cinsi ve ortam sıcaklığına bağlı olarak su ile 1:1 oranında seyreltilir. Banyonun karıştırılması ve uygulamanın iyi havalandırılmış yerlerde yapılması tavsiye edilir. Banyodan çıkarılan parçalar, basınçlı temiz su ile yıkanır.



SPK 100 Sprey Tabancası

Metal aksam içermez.



Silindirik Saplı Kısa Matkap Ucu (HADDELI) TS ISO 235 DIN 338

Kalite : HSS (Yüksek Hız Çeliği)

Takım Tipi : N - uç açısı 118°

Kesme Yönü : Sağ

2.0x49x24 mm	47.48 TL
2.1x49x24 mm	54.04 TL
2.2x53x27 mm	54.04 TL
2.3x53x27 mm	54.04 TL
2.4x57x30 mm	54.04 TL
2.5x57x30 mm	48.66 TL
2.6x57x30 mm	59.91 TL
2.7x61x33 mm	59.91 TL
2.8x61x33 mm	59.91 TL
2.9x61x33 mm	59.91 TL
3.0x61x33 mm	51.37 TL
3.1x65x36 mm	59.91 TL
3.2x65x36 mm	59.91 TL
3.3x65x36 mm	57.80 TL
3.4x70x39 mm	67.00 TL
3.5x70x39 mm	57.55 TL
3.6x70x39 mm	67.00 TL
3.7x70x39 mm	77.28 TL
3.8x75x43 mm	77.28 TL
3.9x75x43 mm	77.28 TL
4.0x75x43 mm	66.18 TL
4.1x75x43 mm	81.48 TL
4.2x75x43 mm	70.35 TL
4.3x80x47 mm	81.48 TL
4.4x80x47 mm	81.48 TL
4.5x80x47 mm	75.07 TL
4.6x80x47 mm	81.48 TL
4.7x80x47 mm	93.21 TL
4.8x86x52 mm	93.21 TL
4.9x86x52 mm	93.21 TL
5.0x86x52 mm	84.21 TL
5.1x86x52 mm	84.11 TL
5.2x86x52 mm	84.11 TL
5.3x86x52 mm	96.72 TL
5.4x93x57 mm	118.54 TL
5.5x93x57 mm	103.75 TL
5.6x93x57 mm	118.54 TL
5.7x93x57 mm	118.54 TL
5.8x93x57 mm	118.54 TL
5.9x93x57 mm	121.06 TL

Silindirik Saplı Kısa Matkap Ucu (HADDELI) TS ISO 235 DIN 338

Kalite : HSS (Yüksek Hız Çeliği)

Takım Tipi : N - uç açısı 118°

Kesme Yönü : Sağ

6.0x93x57 mm	110.38 TL
6.1x101x63 mm	145.73 TL
6.2x101x63 mm	145.73 TL
6.3x101x63 mm	145.73 TL
6.4x101x63 mm	152.50 TL
6.5x101x63 mm	135.58 TL
6.6x101x63 mm	162.00 TL
6.7x101x63 mm	162.00 TL
6.8x109x69 mm	168.69 TL
6.9x109x69 mm	193.36 TL
7.0x109x69 mm	160.59 TL
7.1x109x69 mm	207.10 TL
7.2x109x69 mm	207.10 TL
7.3x109x69 mm	207.10 TL
7.5x109x69 mm	182.80 TL
7.6x117x75 mm	227.39 TL
7.7x117x75 mm	227.39 TL
7.8x117x75 mm	227.39 TL
7.9x117x75 mm	227.39 TL
8.0x117x75 mm	198.17 TL
8.1x117x75 mm	252.90 TL
8.2x117x75 mm	252.90 TL
8.3x117x75 mm	252.90 TL
8.4x117x75 mm	252.90 TL
8.5x117x75 mm	229.41 TL
8.6x125x81 mm	324.75 TL
8.7x125x81 mm	324.75 TL
8.8x125x81 mm	324.75 TL
8.9x125x81 mm	324.75 TL
9.0x125x81 mm	255.63 TL
9.1x125x81 mm	328.87 TL
9.2x125x81 mm	328.87 TL
9.3x125x81 mm	339.76 TL
9.5x125x81 mm	293.23 TL
9.7x133x87 mm	361.04 TL
9.8x133x87 mm	385.03 TL
9.9x133x87 mm	385.03 TL
10.0x133x87 mm	316.20 TL
10.1x133x87 mm	445.02 TL
10.2x133x87 mm	410.90 TL
10.3x133x87 mm	532.55 TL
10.4x133x87 mm	532.55 TL
10.5x133x87 mm	532.55 TL
10.6x133x87 mm	548.97 TL
10.7x142x94 mm	654.27 TL
10.8x142x94 mm	568.58 TL
11.0x142x94 mm	429.52 TL
11.2x142x94 mm	688.79 TL
11.5x142x94 mm	452.86 TL
11.6x142x94 mm	688.79 TL
11.7x142x94 mm	688.79 TL
11.8x142x94 mm	688.79 TL
11.9x151x101 mm	819.51 TL
12.0x151x101 mm	496.93 TL
12.1x151x101 mm	863.09 TL
12.2x151x101 mm	863.09 TL
12.3x151x101 mm	863.09 TL
12.5x151x101 mm	537.65 TL
12.7x151x101 mm	783.72 TL
12.8x151x101 mm	865.50 TL
13.0x151x101 mm	573.96 TL
13.1x151 x101 mm	1081.32 TL

Silindirik Saplı Kısa Matkap Ucu (TAŞLANMIŞ) TS ISO 235 DIN 338

Kalite : HSS (Yüksek Hız Çeliği)

Takım Tipi : N - uç açısı 118°

Kesme Yönü : Sağ

1.0x34x12 mm	68.62 TL
1.5x40x18 mm	48.66 TL
2.0x49x24 mm	53.14 TL
2.5x57x30 mm	57.03 TL
3.0x61x33 mm	57.03 TL
3.5x70x39 mm	67.30 TL
4.0x75x43 mm	74.16 TL
4.5x80x47 mm	87.85 TL
5.0x86x52 mm	94.49 TL
5.5x93x57 mm	126.52 TL
6.0x93x57 mm	129.20 TL
6.5x101x63 mm	165.81 TL
7.0x109x63 mm	187.97 TL
8.0x117x75 mm	231.87 TL
8.5x117x75 mm	280.04 TL
9.0x125x81 mm	299.18 TL
10.0x133x87 mm	370.10 TL
10.5x133x87 mm	447.57 TL
11.0x142x94 mm	502.75 TL
12.0x151x101 mm	581.48 TL
12.5x151x101 mm	656.43 TL
13.0x151x101 mm	671.63 TL
13.5x160x108 mm	1165.90 TL
14.0x160x108 mm	1235.54 TL
14.5x169x114 mm	1379.62 TL
15.0x169x114 mm	1443.18 TL
15.5x178x120 mm	1573.13 TL
16.0x178x120 mm	1699.73 TL
16.5x184x125 mm	1937.49 TL
17.0x184x125 mm	2072.14 TL
17.5x191x130 mm	2259.08 TL
18.0x191x130 mm	2394.86 TL
18.5x198x135 mm	2610.50 TL
19.0x198x135 mm	2819.62 TL
19.5x205x140 mm	3246.98 TL
20.0x205x140 mm	3246.98 TL
20.5x213x145 mm	3653.49 TL
21.0x213x145 mm	3701.99 TL
21.5x221x150 mm	4091.69 TL
22.0x221x150 mm	4172.84 TL
22.5x229x155 mm	4595.20 TL
23.0x229x155 mm	4627.73 TL
23.5x229x155 mm	4708.63 TL
24.0x236x160 mm	5147.21 TL
24.5x236x160 mm	5455.62 TL
25.0x236x160 mm	5699.10 TL



Punto Çürütme Matkap Ucu (Uzun)

Kalite : HSS (%8 Co Alaşımli Yüksek Hız Çeliği)

Kesme Yönü : Sağ

6 mm	366.78 TL
8 mm	458.42 TL



Silindirik Saplı Uzun Matkap Ucu TS ISO 494 DIN 340

Kalite : HSS (Yüksek Hız Çeliği)
Takım Tipi : N - uç açısı 118°
Kesme Yönü : Sağ

1.5x70x45 mm	198.17 TL
2.0x85x56 mm	134.73 TL
2.5x95x62 mm	142.49 TL
3.0x100x66 mm	142.49 TL
3.2x106x69 mm	157.58 TL
3.5x112x73 mm	172.69 TL
4.0x119x78 mm	190.85 TL
4.2x119x78 mm	192.74 TL
4.5x126x82 mm	213.32 TL
5.0x132x87 mm	241.57 TL
5.5x139x91 mm	276.83 TL
6.0x139x91 mm	294.37 TL
6.5x148x97 mm	325.00 TL
7.0x156x102 mm	375.08 TL
7.5x156x102 mm	447.19 TL
8.0x165x109 mm	447.19 TL
8.5x165x109 mm	583.89 TL
9.0x175x115 mm	545.16 TL
9.5x175x115 mm	653.30 TL
10.0x184x121 mm	647.66 TL
10.5x184x121 mm	925.43 TL
11.0x195x128 mm	952.82 TL
11.5x195x128 mm	1067.19 TL
12.0x205x134 mm	1196.35 TL
12.5x205x134 mm	1196.35 TL
13.0x205x134 mm	1274.88 TL
13.5x214x140 mm	1441.87 TL
14.0x214x140 mm	1629.75 TL
15.0x220x144 mm	2000.35 TL
16.0x227x149 mm	2380.92 TL
17.0x235x154 mm	2849.11 TL
17.5x241x158 mm	3702.07 TL
18.0x241x158 mm	3190.41 TL



Silindirik Saplı Kısa Matkap Ucu ALTIN SERİ TS ISO 235 DIN 338

Kalite : HSS -E
Takım Tipi : H8 - uç açısı 135°
Kesme Yönü : Sağ

1.0 mm	130.41 TL
1.5 mm	93.48 TL
1.8 mm	189.15 TL
2.0 mm	91.87 TL
2.5 mm	94.35 TL
2.6 mm	129.15 TL
3.0 mm	100.84 TL
3.1 mm	129.12 TL
3.2 mm	129.12 TL
3.3 mm	124.15 TL
3.5 mm	117.12 TL
3.8 mm	166.31 TL
4.0 mm	141.50 TL
4.2 mm	151.41 TL
4.3 mm	175.01 TL
4.5 mm	159.64 TL
4.8 mm	199.65 TL
5.0 mm	180.41 TL
5.1 mm	179.07 TL
5.2 mm	179.94 TL
5.3 mm	207.35 TL
5.5 mm	220.87 TL
6.0 mm	235.56 TL
6.1 mm	314.43 TL
6.2 mm	314.43 TL
6.5 mm	289.19 TL
6.7 mm	350.41 TL
6.8 mm	365.75 TL
7.0 mm	346.19 TL
7.2 mm	448.09 TL
7.5 mm	392.42 TL
8.0 mm	421.07 TL
8.1 mm	547.48 TL
8.2 mm	547.48 TL
8.5 mm	489.75 TL
8.7 mm	697.67 TL
8.8 mm	697.67 TL
9.0 mm	548.66 TL
9.5 mm	623.58 TL
9.8 mm	822.46 TL
10.0 mm	670.23 TL
10.2 mm	877.83 TL
10.5 mm	779.66 TL
11.0 mm	910.27 TL
11.5 mm	958.68 TL
12.0 mm	1060.17 TL
12.5 mm	1144.36 TL
13.0 mm	1219.02 TL



Silindirik Saplı Kısa Matkap Ucu ALTIN SERİ TS ISO 235 DIN 338

Kalite : HSS -E
Takım Tipi : H8 - uç açısı 135°
Kesme Yönü : Sağ

13.5 mm	2088.86 TL
14.0 mm	2210.21 TL
14.5 mm	2469.14 TL
15.0 mm	2585.90 TL
15.5 mm	2695.08 TL
16.0 mm	2958.50 TL
16.5 mm	3077.04 TL
17.0 mm	3226.82 TL
17.5 mm	3460.63 TL
18.0 mm	3507.25 TL
18.5 mm	3814.94 TL
19.0 mm	4146.23 TL
19.5 mm	4536.07 TL
20.0 mm	4629.59 TL



Punta Matkabı DIN 333/Form -A Helis Kanallı TS ISO 866

Kalite : HSS
Takım Tipi : N - uç açısı 118° (60°)
Kesme Yönü : Sağ

1.0 mm	180.19 TL
1.25 mm	180.19 TL
1.6 mm	190.65 TL
2.0 mm	240.79 TL
2.5 mm	306.52 TL
3.15 mm	355.01 TL
4.0 mm	465.18 TL
5.0 mm	665.70 TL
6.3 mm	1266.67 TL
8.0 mm	2191.95 TL
10.0 mm	4300.74 TL
12.5 mm	6922.67 TL



Silindirik Saplı Çok Uzun Matkap Ucu DIN 1869-1 Nr:1

Kalite : HSS (Yüksek Hız Çeliği)
Takım Tipi : N - uç açısı 118°
Kesme Yönü : Sağ

2.0x125x85 mm	513.73 TL
2.5x140x95 mm	536.39 TL
3.0x150x100 mm	600.95 TL
4.0x175x120 mm	645.42 TL
4.5x185x125 mm	738.44 TL
5.0x195x135 mm	746.08 TL
5.5x205x140 mm	861.04 TL
6.0x205x140 mm	903.49 TL
6.5x215x150 mm	1001.52 TL
7.0x225x150 mm	1132.85 TL
7.5x225x155 mm	1370.01 TL
8.0x240x165 mm	1466.02 TL
8.5x240x165 mm	1860.58 TL
9.0x250x175 mm	2053.11 TL
9.5x250x175 mm	2203.18 TL
10.0x265x185 mm	2217.01 TL
10.5x265x185 mm	3240.98 TL
11.0x280x195 mm	3929.11 TL
11.5x280x195 mm	4311.11 TL
12.0x295x205 mm	4342.00 TL
12.5x295x205 mm	4525.42 TL
13.0x295x205 mm	4571.29 TL





Mors Konik Saplı Matkap Ucu DIN 345, TS ISO 235

Kalite : HSS

Vida Profili : N - uç açısı 118°

Kesme Yönü : Sağ

10.0 mm	1035.62 TL
11.5 mm	1105.88 TL
12.0 mm	1128.39 TL
13.0 mm	1182.54 TL
13.5 mm	1345.45 TL
14.0 mm	1509.93 TL
14.5 mm	1736.79 TL
15.0 mm	1759.95 TL
15.5 mm	1911.28 TL
16.0 mm	1975.45 TL
16.5 mm	2033.72 TL
17.0 mm	2092.14 TL
17.5 mm	2144.21 TL
18.0 mm	2251.74 TL
18.5 mm	2395.80 TL
19.0 mm	2574.61 TL
19.5 mm	2737.77 TL
20.0 mm	2751.66 TL
20.5 mm	3025.36 TL
21.0 mm	3067.16 TL
21.5 mm	3400.25 TL
22.0 mm	3469.62 TL
22.5 mm	3802.79 TL
23.0 mm	3844.31 TL
23.5 mm	3885.84 TL
24.0 mm	4260.54 TL
24.5 mm	4538.43 TL
25.0 mm	4718.59 TL
25.5 mm	5315.22 TL
26.0 mm	5551.08 TL
26.5 mm	5759.49 TL
27.0 mm	6092.40 TL
27.5 mm	6300.55 TL
28.0 mm	6494.71 TL
28.5 mm	6744.57 TL
29.0 mm	6994.13 TL
29.5 mm	7272.04 TL
30.0 mm	7521.90 TL
30.5 mm	7757.80 TL
31.0 mm	8090.80 TL
31.5 mm	8340.68 TL
32.0 mm	8659.71 TL
32.5 mm	8979.04 TL
33.0 mm	9312.05 TL
33.5 mm	9631.13 TL
34.0 mm	10006.11 TL
34.5 mm	10311.05 TL
35.0 mm	10699.79 TL
35.5 mm	11143.88 TL
36.0 mm	11629.56 TL
36.5 mm	12198.56 TL
37.0 mm	12378.85 TL
38.0 mm	13933.12 TL
39.0 mm	15223.82 TL
39.5 mm	15945.45 TL
40.0 mm	16597.78 TL



Whitworth Boru Vidalı El Klavuzu 2'li Takım, TS 82/3, DIN 5157

Kalite : HSS

Vida Profili : BSP 55°

Kesme Yönü : Sağ

G 1/8" x 28 mm	1849.31 TL
G 1/4" x 19 mm	2446.22 TL
G 3/8" x 19 mm	2804.13 TL
G 1/2" x 14 mm	3767.96 TL
G 3/4" x 14 mm	5871.92 TL
G 1" x 11 mm	10079.53 TL



USA Vidalı El Klavuzu 3'lü Takım, UNC, DIN 351

Kalite : HSS

Vida Profili : UNC (2B) 60°

Kesme Yönü : Sağ

1/4" x 20 mm	1656.25 TL
1/2" x 13 mm	3115.02 TL
3/4" x 10 mm	6183.35 TL
7/8" x 9 mm	8881.79 TL
1" x 8 mm	11256.15 TL



Metrik Normal Vidalı Pafta Lokma TS 3600/1 DIN 223/B 568 Metrik

Kalite : HSS

Vida Profili : ISO 60°

Kesme Yönü : Sağ

M2 x 0.4 mm	1198.50 TL
M2.5 x 0.45 mm	1169.35 TL
M3 x 0.5 mm	892.25 TL
M3.5 x 0.6 mm	1043.65 TL
M4 x 0.7 mm	892.25 TL
M5 x 0.8 mm	818.33 TL
M6 x 1.0 mm	818.33 TL
M7 x 1.0 mm	1141.70 TL
M8 x 1.25 mm	959.54 TL
M9 x 1.25 mm	1244.58 TL
M10 x 1.50 mm	1174.13 TL
M12 x 1.75 mm	1495.86 TL
M14 x 2.0 mm	1722.45 TL
M16 x 2.0 mm	2431.96 TL
M18 x 2.5 mm	2453.57 TL
M20 x 2.5 mm	2453.57 TL



Metrik Normal Vidalı El Klavuzu 3'lü Takım, TS 82/1 DIN 352 Metrik

Kalite : HSS

Vida Profili : (6H) 60°

Kesme Yönü : Sağ

M2 x 0.4 mm	1641.92 TL
M2.5 x 0.45 mm	1641.92 TL
M3 x 0.5 mm	996.12 TL
M4 x 0.7 mm	996.12 TL
M5 x 0.8 mm	1012.55 TL
M6 x 1.0 mm	1069.48 TL
M8 x 1.25 mm	1179.67 TL
M10 x 1.50 mm	1595.65 TL
M12 x 1.75 mm	2142.82 TL
M14 x 2.0 mm	2536.42 TL
M16 x 2.0 mm	3071.94 TL
M18 x 2.5 mm	4414.04 TL
M20 x 2.5 mm	4965.51 TL
M22 x 2.5 mm	6606.28 TL
M24 x 3.0 mm	7813.63 TL
M27 x 3.0 mm	11228.82 TL



Metrik İnce Vidalı El Klavuzu 2'li Takım, TS 82/2 DIN 2181

Kalite : HSS

Vida Profili : MF (6H) 60°

Kesme Yönü : Sağ

M8 x 1.0 mm	1162.60 TL
M10 x 1.25 mm	2233.81 TL
M10 x 1.0 mm	1848.91 TL
M12 x 1.25 mm	2542.78 TL
M12 x 1.0 mm	2157.41 TL
M12 x 1.5 mm	2001.64 TL
M14 x 1.5 mm	2542.78 TL
M16 x 1.5 mm	2848.15 TL
M18 x 1.5 mm	3560.14 TL
M20 x 1.5 mm	3957.68 TL
M22 x 1.5 mm	5760.34 TL
M24 x 1.5 mm	6554.91 TL
M27 x 2.0 mm	9008.15 TL





Metrik Normal Vidalı Düz Kanallı Makina Klavuzu TS 82/4 DIN 371/C Metrik

Kalite : HSS -E
Vida Profili : (6H) 60°
Kesme Yönü : Sağ

M3 x 0.5 mm	689.13 TL
M4 x 0.7 mm	710.73 TL
M5 x 0.8 mm	710.73 TL
M6 x 1.0 mm	768.80 TL
M8 x 1.25 mm	867.17 TL
M10 x 1.50 mm	1024.83 TL
M12 x 1.75 mm	1239.16 TL



Metrik İnce Vidalı Helis Kanallı Makina Klavuzu TS 82/6, Metrik

Kalite : HSS -E
Vida Profili : (6H) R35
Kesme Yönü : Sağ

M8 x 1.0 mm	1660.29 TL
M10 x 1.25 mm	1887.95 TL
M10 x 1.0 mm	1699.65 TL
M12 x 1.0 mm	1808.64 TL
M12 x 1.5 mm	1808.64 TL
M12 x 1.25 mm	1930.04 TL
M14 x 1.0 mm	2334.99 TL
M14 x 1.5 mm	2196.23 TL
M16 x 1.5 mm	2444.09 TL
M18 x 1.5 mm	2928.47 TL
M20 x 1.5 mm	3723.14 TL
M22 x 1.5 mm	4049.96 TL
M24 x 1.5 mm	4376.89 TL



Metaller için Makina Testere Lamaları TSE 153/4

Kalite : HSS

350 x 30 x 1.5 Z=6	554.57 TL
350 x 30 x 1.5 Z=8	554.57 TL
350 x 30 x 1.5 Z=10	554.57 TL
500 x 40 x 2.0 Z=4	1172.81 TL
500 x 40 x 2.0 Z=6	1172.81 TL
500 x 40 x 2.0 Z=8	1172.81 TL
500 x 40 x 2.0 Z=10	1172.81 TL



Metrik Normal Vidalı Düz Kanallı Makina Klavuzu TS 82/5 DIN 376/C Metrik

Kalite : HSS -E
Vida Profili : (6H) 60°
Kesme Yönü : Sağ

M14 x 2.0 mm	1817.74 TL
M16 x 2.0 mm	2058.30 TL
M18 x 2.5 mm	2993.02 TL
M20 x 2.5 mm	3084.58 TL
M22 x 2.5 mm	4408.89 TL
M24 x 3.0 mm	4212.92 TL
M27 x 3.0 mm	5582.14 TL
M30 x 3.5 mm	6770.86 TL



Metrik Normal Vidalı Helis Kanallı Makina Klavuzu TS 82/4 DIN 371/C Helis

Vida Profili : (6H) R35

M3 x 0.5 mm	825.51 TL
M4 x 0.7 mm	851.53 TL
M5 x 0.8 mm	851.53 TL
M6 x 1.0 mm	921.88 TL
M8 x 1.25 mm	1041.37 TL
M10 x 1.50 mm	1226.91 TL
M12 x 1.75 mm	1482.56 TL



Metrik Normal Vidalı Helis Kanallı Makina Klavuzu TS 82/5 DIN 376/C Metrik

Kalite : HSS -E
Vida Profili : (6H) 60° R35
Kesme Yönü : Sağ

M14 x 2.0 mm	2178.73 TL
M16 x 2.0 mm	2471.91 TL
M18 x 2.5 mm	3596.22 TL
M20 x 2.5 mm	3701.15 TL
M22 x 2.5 mm	5296.23 TL
M24 x 3.0 mm	5070.72 TL
M27 x 3.0 mm	6695.34 TL
M30 x 3.5 mm	8124.66 TL



Metrik İnce Vidalı Düz Kanallı Makina Klavuzu TS 82/6 DIN 374/C Metrik

Kalite : HSS -E
Vida Profili : (6H) 60°
Kesme Yönü : Sağ

M8 x 1.0 mm	1387.94 TL
M10 x 1.25 mm	1574.87 TL
M10 x 1.0 mm	1415.83 TL
M12 x 1.25 mm	1609.18 TL
M12 x 1.0 mm	1507.69 TL
M12 x 1.5 mm	1507.69 TL
M14 x 1.0 mm	1942.36 TL
M14 x 1.5 mm	1830.49 TL
M16 x 1.5 mm	2035.96 TL
M18 x 1.5 mm	2439.01 TL
M18 x 2.0 mm	2750.78 TL
M20 x 1.5 mm	3098.05 TL
M22 x 1.5 mm	3380.04 TL
M24 x 1.5 mm	3644.83 TL
M24 x 2.0 mm	4134.56 TL



BAHCO Bimetal El Testeresi

300 x 13 x 0.8 2.80 € /Adet



Metaller için El Testere Lamaları (Çift Ağız) TSE 153/3

Kalite : WS (Kromlu Çelik)

300 x 13 x 0.8 Z=18	32.55 TL
300 x 25 x 0.8 Z=18	41.45 TL



Sandvik Makina Destereleri Bimetal M2

300x25x1,25 mm 10 Diş
350x32x1.6 mm 6 diş
350x32x1.6 mm 8 diş





**Torna Kalemi Kare Kesitli
TS 95/1 Tip : B
DIN 4964**

Kalite : HSS - E (%10 cO Alaşım) Yüksek Hız Çeliği

8 x 8 x 100 mm	643.10 TL
8 x 8 x 125 mm	727.14 TL
8 x 8 x 160 mm	863.37 TL
8 x 8 x 200 mm	1236.29 TL
10 x 10 x 100 mm	891.56 TL
10 x 10 x 125 mm	1003.83 TL
10 x 10 x 160 mm	1244.37 TL
10 x 10 x 200 mm	1530.83 TL
12 x 12 x 100 mm	1092.03 TL
12 x 12 x 125 mm	1286.35 TL
12 x 12 x 160 mm	1592.97 TL
12 x 12 x 200 mm	1945.28 TL
14 x 14 x 125 mm	1805.17 TL
14 x 14 x 160 mm	1865.27 TL
14 x 14 x 200 mm	2324.12 TL
16 x 16 x 125 mm	1917.27 TL
16 x 16 x 160 mm	2386.52 TL
16 x 16 x 200 mm	2971.08 TL
20 x 20 x 160 mm	3646.40 TL
20 x 20 x 200 mm	4487.84 TL
25 x 25 x 200 mm	8374.57 TL



**Silindirik Saplı El Raybası
TS 78/3 DIN 206/B**

2.0 mm	1112.83 TL
2.5 mm	1126.36 TL
3.0 mm	1127.50 TL
4.0 mm	1088.54 TL
5.0 mm	1256.75 TL
6.0 mm	1205.13 TL
7.0 mm	1323.31 TL
8.0 mm	1374.67 TL
8.5 mm	1521.16 TL
9.0 mm	1539.09 TL
10.0 mm	1539.09 TL
11.0 mm	1746.56 TL
12.0 mm	1844.15 TL
13.0 mm	2849.20 TL
14.0 mm	3134.62 TL
15.0 mm	3338.21 TL
16.0 mm	3487.51 TL
18.0 mm	4030.49 TL
20.0 mm	4233.90 TL



Kademeli Matkap HSS

4 - 12 mm	1995.14 TL
4 - 20 mm	3023.35 TL
4 - 30 mm	4453.00 TL
4 - 39 mm	6893.26 TL



**Silindirik Saplı Parmak Freze Kısa
TS 303/20 DIN 844/BN**

Kalite : HSS - E
Kesme Yönü : Sağ

2.0 mm	748.63 TL
2.5 mm	796.50 TL
3.0 mm	536.62 TL
4.0 mm	536.62 TL
5.0 mm	536.62 TL
6.0 mm	545.76 TL
7.0 mm	704.45 TL
8.0 mm	704.45 TL
9.0 mm	838.46 TL
10.0 mm	783.61 TL
11.0 mm	1041.60 TL
12.0 mm	1000.31 TL
13.0 mm	1289.74 TL
14.0 mm	1366.11 TL
15.0 mm	1585.60 TL
16.0 mm	1585.60 TL
17.0 mm	1980.33 TL
18.0 mm	1871.95 TL
19.0 mm	2412.59 TL
20.0 mm	2349.35 TL
22.0 mm	3109.85 TL
24.0 mm	4131.23 TL
25.0 mm	4131.23 TL
26.0 mm	5046.03 TL
28.0 mm	5289.87 TL
30.0 mm	5610.07 TL
32.0 mm	6128.01 TL



**Silindirik Saplı Makina Raybası
TS 78/4 DIN 212/D**

2.0 mm	980.70 TL
2.5 mm	980.70 TL
3.0 mm	937.68 TL
3.5 mm	967.75 TL
4.0 mm	1028.67 TL
4.5 mm	1101.42 TL
5.0 mm	1002.46 TL
5.5 mm	1269.21 TL
6.0 mm	1128.87 TL
6.5 mm	1334.40 TL
7.0 mm	1355.32 TL
8.0 mm	1395.60 TL
8.5 mm	1468.40 TL
9.0 mm	1468.40 TL
10.0 mm	1636.06 TL
10.5 mm	1801.34 TL
11.0 mm	2131.47 TL
12.0 mm	2408.48 TL
12.5 mm	2582.98 TL
13.0 mm	2796.10 TL
14.0 mm	2926.12 TL
15.0 mm	3017.08 TL
16.0 mm	3121.01 TL
17.0 mm	3498.27 TL
18.0 mm	3810.34 TL
19.0 mm	4304.41 TL
20.0 mm	4278.63 TL



**Torna Kalemi - Trapez Kesitli
TS 95/1 Tip : E
DIN 4964**

Kalite : HSS - E (%10 cO Alaşım) Yüksek Hız Çeliği

3 x 12 160 mm	982.79 TL
4 x 16 x 160 mm	1380.76 TL
5 x 20 x 160 mm	1570.64 TL
5 x 20 x 200 mm	1884.62 TL



**3 Ağızlı Silindirik Saplı Havşa Freze
TS 3751/10 DIN 335/C**

Kalite : HSS

6.3 mm	713.46 TL
8.3 mm	784.56 TL
10.4 mm	965.27 TL
12.4 mm	1027.78 TL
16.5 mm	1278.11 TL
20.5 mm	1720.78 TL
25.0 mm	2369.77 TL
31.5 mm	4119.43 TL





HSS Tin Kaplı Metal Matkap Uçları DIN 338

1.0 x 34 mm	1600	0.15 \$
1.5 x 40 mm	1601	0.15 \$
2.0 x 49 mm	1602	0.17 \$
2.5 x 57 mm	1603	0.21 \$
3.0 x 61 mm	1604	0.25 \$
3.2 x 61 mm	1605	0.28 \$
3.5 x 70 mm	1606	0.31 \$
4.0 x 75 mm	1607	0.35 \$
4.2 x 75 mm	1608	0.40 \$
4.5 x 80 mm	1609	0.43 \$
5.0 x 86 mm	1610	0.48 \$
5.5 x 93 mm	1611	0.58 \$
6.0 x 93 mm	1612	0.65 \$
6.5 x 101 mm	1613	0.80 \$
7.0 x 109 mm	1614	0.90 \$
7.5 x 109 mm	1615	0.98 \$
8.0 x 117 mm	1616	1.18 \$
8.5 x 117 mm	1617	1.30 \$
9.0 x 125 mm	1618	1.47 \$
9.5 x 125 mm	1619	1.65 \$
10.0 x 133 mm	1620	1.95 \$
10.5 x 133 mm	1621	2.10 \$
11.0 x 142 mm	1622	2.35 \$
11.5 x 142 mm	1623	2.65 \$
12.0 x 151 mm	1624	2.90 \$
12.5 x 151 mm	1625	3.10 \$
13.0 x 151 mm	1626	3.40 \$
13.5 x 160 mm	1627	4.10 \$
14.0 x 133 mm	1628	4.40 \$
14.5 x 133 mm	1629	5.00 \$
15.0 x 133 mm	1630	5.25 \$
15.5 x 133 mm	1631	6.00 \$
16.0 x 142 mm	1632	6.25 \$
16.5 x 142 mm	1633	7.00 \$
17.0 x 142 mm	1634	7.20 \$
17.5 x 142 mm	1635	7.80 \$
18.0 x 151 mm	1636	8.50 \$
18.5 x 151 mm	1637	9.00 \$
19.0 x 151 mm	1638	9.50 \$
19.5 x 151 mm	1639	10.00 \$
20.0 x 151 mm	1640	10.40 \$



HSS Mors Konik Saplı Matkap Uçları DIN 345

15.0 mm	MK 2	1900	7.70 \$
15.5 mm	MK 2	1901	8.10 \$
16.0 mm	MK 2	1902	8.50 \$
16.5 mm	MK 2	1903	9.00 \$
17.0 mm	MK 2	1904	9.10 \$
17.5 mm	MK 2	1905	9.60 \$
18.0 mm	MK 2	1906	9.80 \$
18.5 mm	MK 2	1907	10.30 \$
19.0 mm	MK 2	1908	10.60 \$
19.5 mm	MK 2	1909	11.20 \$
20.0 mm	MK 2	1910	11.50 \$
20.5 mm	MK 2	1911	13.60 \$
21.0 mm	MK 2	1912	14.00 \$
21.5 mm	MK 2	1913	14.40 \$
22.0 mm	MK 2	1914	14.60 \$
22.5 mm	MK 2	1915	15.70 \$
23.0 mm	MK 2	1916	16.10 \$
23.5 mm	MK 3	1917	18.00 \$
24.0 mm	MK 3	1918	18.20 \$
24.5 mm	MK 3	1919	20.00 \$
25.0 mm	MK 3	1920	20.20 \$
25.5 mm	MK 3	1921	21.50 \$
26.0 mm	MK 3	1922	21.70 \$
26.5 mm	MK 3	1923	23.30 \$
27.0 mm	MK 3	1924	23.60 \$
27.5 mm	MK 3	1925	24.50 \$
28.0 mm	MK 3	1926	25.00 \$
28.5 mm	MK 3	1927	26.50 \$
29.0 mm	MK 3	1928	27.30 \$
29.5 mm	MK 3	1929	27.50 \$
30.0 mm	MK 3	1930	27.80 \$
30.5 mm	MK 3	1931	33.80 \$
31.0 mm	MK 3	1932	34.00 \$
31.5 mm	MK 3	1933	37.70 \$
32.0 mm	MK 4	1934	38.90 \$
32.5 mm	MK 4	1935	40.10 \$
33.0 mm	MK 4	1936	41.60 \$
33.5 mm	MK 4	1937	43.90 \$
34.0 mm	MK 4	1938	44.20 \$
34.5 mm	MK 4	1939	46.60 \$
35.0 mm	MK 4	1940	47.00 \$
35.5 mm	MK 4	1941	49.30 \$
36.0 mm	MK 4	1942	50.00 \$
36.5 mm	MK 4	1943	53.00 \$
37.0 mm	MK 4	1944	53.50 \$
37.5 mm	MK 4	1945	55.50 \$
38.0 mm	MK 4	1946	56.50 \$
38.5 mm	MK 4	1947	60.00 \$
39.0 mm	MK 4	1948	60.50 \$
39.5 mm	MK 4	1949	61.00 \$
40.0 mm	MK 4	1950	61.50 \$
40.5 mm	MK 4	1951	69.00 \$
41.0 mm	MK 4	1952	69.50 \$
41.5 mm	MK 4	1953	70.00 \$
42.0 mm	MK 4	1954	71.00 \$
45.0 mm	MK 4	1955	80.00 \$
50.0 mm	MK 4	1956	99.50 \$



HSS Metal Matkap Uçları (Siyah Beyaz DIN 338)

1.0 mm	1502	0.12 \$
1.5 mm	1503	0.12 \$
2.0 mm	1504	0.14 \$
2.5 mm	1505	0.16 \$
3.0 mm	1506	0.17 \$
3.2 mm	1507	0.18 \$
3.5 mm	1508	0.18 \$
4.0 mm	1510	0.22 \$
4.2 mm	1511	0.23 \$
4.5 mm	1512	0.25 \$
5.0 mm	1513	0.30 \$
5.2 mm	1514	0.33 \$
5.5 mm	1515	0.36 \$
5.8 mm	1516	0.37 \$
6.0 mm	1517	0.41 \$
6.5 mm	1518	0.50 \$
7.0 mm	1519	0.59 \$
7.5 mm	1520	0.64 \$
8.0 mm	1521	0.76 \$
8.5 mm	1522	0.86 \$
9.0 mm	1523	0.97 \$
9.5 mm	1524	1.08 \$
10.0 mm	1525	1.20 \$
10.5 mm	1526	1.35 \$
11.0 mm	1527	1.53 \$
11.5 mm	1528	1.67 \$
12.0 mm	1529	1.93 \$
12.5 mm	1530	2.10 \$
13.0 mm	1531	2.30 \$
13.5 mm	1532	2.88 \$
14.0 mm	1533	3.10 \$
14.5 mm	1534	3.58 \$
15.0 mm	1535	3.78 \$
15.5 mm	1536	4.17 \$
16.0 mm	1537	4.60 \$
16.5 mm	1538	5.10 \$
17.0 mm	1539	5.30 \$
17.5 mm	1540	5.75 \$
18.0 mm	1541	6.18 \$
18.5 mm	1542	6.70 \$
19.0 mm	1543	7.00 \$
19.5 mm	1544	7.70 \$
20.0 mm	1545	7.95 \$



HSS Ondalıkli Matkap Uçları DIN 338

1.0 - 1.4 mm	15306	0.46 \$
1.6 - 1.9 mm	15311	0.46 \$
2.1 - 2.4 mm	15316	0.69 \$
2.6 - 2.9 mm	15321	0.89 \$
3.1 - 3.4 mm	15326	1.12 \$
3.6 - 3.9 mm	15331	1.29 \$
4.1 - 1.4 mm	15336	1.43 \$
4.6 - 4.9 mm	15341	1.58 \$
5.1 - 5.4 mm	15346	1.86 \$
5.6 - 5.9 mm	15351	2.16 \$
6.1 - 6.4 mm	15356	2.58 \$
6.6 - 6.9 mm	15361	3.91 \$
7.1 - 7.4 mm	15366	3.91 \$
7.6 - 7.9 mm	15371	4.25 \$
8.1 - 8.4 mm	15376	5.05 \$
8.6 - 8.9 mm	15381	6.55 \$
9.1 - 9.4 mm	15386	6.55 \$
9.6 - 9.9 mm	15391	6.55 \$

HSS Mors Konik Saplı Matkap Uçları DIN 345

43.0 mm	MK 4	15208	72.00 \$
44.0 mm	MK 4	15210	74.00 \$
46.0 mm	MK 4	15214	84.00 \$
47.0 mm	MK 4	15216	88.00 \$
48.0 mm	MK 4	15218	97.00 \$
49.0 mm	MK 4	15220	99.00 \$



Beton İçin Elmas Matkap Uçları

4 mm	53810	0.38 \$
5 mm	53811	0.38 \$
6 mm	53812	0.44 \$
7 mm	53813	0.52 \$
8 mm	53814	0.58 \$
9 mm	53815	0.69 \$
10 mm	53816	0.80 \$
12 mm	53818	0.94 \$
14 mm	53819	1.10 \$
16 mm	53820	1.20 \$



Beton İçin Elmas Matkap Uçları Süper Kalite

4 mm	53850	0.60 \$
5 mm	53851	0.71 \$
6 mm	53852	0.82 \$
7 mm	53853	0.98 \$
8 mm	53854	1.14 \$
10 mm	53856	1.70 \$
12 mm	53857	2.14 \$

HSS Metal Matkap Ucu Siyah Beyaz DIN 338

1.0 mm	MU0889	0.09 \$
1.5 mm	MU0890	0.10 \$
2.0 mm	MU0900	0.10 \$
2.5 mm	MU0910	0.10 \$
3.0 mm	MU0920	0.11 \$
3.5 mm	MU0930	0.13 \$
4.0 mm	MU0940	0.14 \$
4.2 mm	MU0950	0.16 \$
4.5 mm	MU0960	0.17 \$
5.0 mm	MU0970	0.20 \$
5.5 mm	MU0980	0.25 \$
6.0 mm	MU0990	0.29 \$
6.5 mm	MU1000	0.34 \$
7.0 mm	MU1010	0.41 \$
7.5 mm	MU1020	0.48 \$
8.0 mm	MU1030	0.55 \$
8.5 mm	MU1040	0.64 \$
9.0 mm	MU1050	0.71 \$
9.5 mm	MU1060	0.86 \$
10.0 mm	MU1070	0.98 \$
10.5 mm	MU1080	1.10 \$
11.0 mm	MU1090	1.25 \$
11.5 mm	MU1100	1.30 \$
12.0 mm	MU1110	1.55 \$
12.5 mm	MU1120	1.70 \$
13.0 mm	MU1130	1.80 \$
13.5 mm	MU1140	1.90 \$
14.0 mm	MU1150	2.00 \$
14.5 mm	MU1160	2.75 \$
15.0 mm	MU1170	3.20 \$
16.0 mm	MU1180	3.70 \$
17.0 mm	MU1190	4.22 \$
18.0 mm	MU1200	4.90 \$
19.0 mm	MU1210	5.00 \$
20.0 mm	MU1220	5.30 \$

Klavuz Kolu

No: 1 (M3 - M10)	4250	6.70 \$
No: 2 (M4 - M12)	4251	9.20 \$
No: 3 (M5 - M20)	4252	15.20 \$
No: 4 (M9 - M27)	4253	21.50 \$

Cırcırlı Klavuz Kolu

M3 - M8 Kısa	4150	8.40 \$
M5 - M12 Kısa	4151	11.80 \$
M3 - M8 Uzun	4200	12.30 \$
M5 - M12 Uzun	4201	15.30 \$

Pafta Kolu

20 mm (M4 - M6)	4300	4.90 \$
25 mm (M7 - M9)	4301	6.30 \$
30 mm (M10 - M11)	4302	8.00 \$
38 mm (M12 - M14)	4303	9.30 \$
45 mm (M16 - M20)	4304	13.50 \$
55 mm (M22 - M24)	4305	21.50 \$



Klavuz ve Pafta Takımları

45 parça Metrik	62635	169.- \$
45 Parça İnç	62636	169.- \$

Metrik Set İçeriği

M6x1.0, M8x1.25, M10x1.50, M12x1.75, M14x2.0, M16x2.0, M18x2.50, M20x2.50, M22x2.50, M24x3.0 normal diş klavuz ve pafta M6x0.75, M8x1.0, M10x1.25, M12x1.5, M14x1.5, M16x1.5, M18x1.50, M20x1.50, M22x1.50, M24x1.50 incediş klavuz ve paftalar ile klavuz kolu, pafta kolu, toplam 45 parça kesici metal taşıyıcı kutu içindedir. Klavuzlar 3 numar1 1 klavuzda uygulaması kolay, yüksek hız çeliğinden mamül kesici takım seti her atölye ve şantiyeye lazım settir.

40 Parça	3960	43.- \$
Klavuz ve Pafta Takım		

40 Parça	MK2600	38.90 \$
Klavuz ve Pafta Takım		



6 Parça Ters Klavuz

Hafif Hizmet	3951	6.30 \$
3-6 mm, 6-8 mm, 8-11 mm		
11-14 mm, 14-18 mm, 18-20 mm		

6 Parça Ters Klavuz

Ağır Hizmet	3956	8.50 \$
3-6 mm, 6-8 mm, 8-11 mm		
11-14 mm, 14-18 mm, 18-20 mm		

5 Parça Ters Klavuz

Ağır Hizmet	3955	6.20 \$
3-6 mm, 6-8 mm, 8-11 mm		
11-14 mm, 14-18 mm		

HSS Tin Kaplı İnce Diş

Makina Klavuzları DIN 371

M8 x 1.0	3400	4.20 \$
M10 x 1.00	3401	5.20 \$
M10 x 1.25	3402	5.20 \$

HSS Tin Kaplı İnce Diş

Makina Klavuzları DIN 376

M12 x 1.00	3403	7.40 \$
M12 x 1.25	3404	7.40 \$
M12 x 1.50	3405	7.40 \$
M14 x 1.00	3406	9.30 \$
M14 x 1.25	3407	9.30 \$
M14 x 1.50	3408	9.30 \$
M16 x 1.00	3409	10.10 \$
M16 x 1.50	3410	10.10 \$
M18 x 1.00	3411	12.45 \$
M18 x 1.50	3412	12.45 \$
M20 x 1.00	3413	17.60 \$
M20 x 1.50	3414	17.60 \$
M22 x 1.50	3415	21.00 \$

Metrik HSS 3'lü Takım Ei Klavuzları DIN 352

HSS Taşlanmış,

M3 x 0.5	3300	5.90 \$
M4 x 0.7	3301	5.90 \$
M5 x 0.8	3302	6.00 \$
M6 x 1.0	3303	6.20 \$
M8 x 1.25	3304	6.90 \$
M10 x 1.50	3305	7.70 \$
M12 x 1.75	3306	13.00 \$
M14 x 2.00	3307	16.20 \$
M16 x 2.00	3308	18.00 \$
M18 x 2.50	3309	18.70 \$
M20 x 2.50	3310	19.25 \$
M22 x 2.50	3311	27.00 \$
M24 x 3.00	3312	37.50 \$
M27 x 3.00	3314	59.00 \$
M30 x 3.50	3315	94.00 \$

HSS Tekli Son Klavuz DIN 352

M5 x 0.8	3580	2.00 \$
M6 x 1.0	3581	2.10 \$
M8 x 1.25	3582	2.25 \$
M10 x 1.5	3583	2.60 \$
M 12 1.75	3584	4.30 \$

Metrik HSS Tin Kaplı Makine Klavuzları ISO 529 DIN 371 - Helis Kanal

M2.5 x 0.45	3549	6.50 \$
M3 x 0.5	3550	3.30 \$
M4 x 0.7	3551	3.30 \$
M5 x 0.8	3552	3.85 \$
M6 x 1.0	3553	4.40 \$
M8 x 1.25	3554	5.20 \$
M10 x 1.50	3555	5.80 \$

Metrik HSS Tin Kaplı Makine Klavuzları ISO 529 DIN 376 - Helis Kanal

M12 x 1.75	3556	8.00 \$
M14 x 2.00	3558	10.50 \$
M16 x 2.00	3559	13.00 \$
M18 x 2.50	3560	15.00 \$
M20 x 2.50	3561	19.50 \$
M22 x 2.50	3562	28.00 \$
M24 x 3.00	3563	35.00 \$
M27 x 3.00	3564	45.00 \$

**Metrik HSS Tin Kaplı
Makine Klavuzları ISO 529
DIN 371 - Düz Kanal**

M3 x 0.5	3500	3.10 \$
M4 x 0.7	3501	3.10 \$
M5 x 0.8	3502	3.40 \$
M6 x 1.0	3503	3.40 \$
M8 x 1.25	3504	4.10 \$
M10 x 1.50	3505	5.00 \$

**Metrik HSS Tin Kaplı
Makine Klavuzları ISO 529
DIN 376 - Düz Kanal**

M12 x 1.75	3506	7.20 \$
M14 x 2.00	3507	9.25 \$
M16 x 2.00	3508	10.25 \$
M18 x 2.50	3509	12.45 \$
M20 x 2.50	3510	18.00 \$
M22 x 2.50	3511	20.00 \$
M24 x 3.00	3512	30.00 \$
M27 x 3.00	3513	39.00 \$
M30 x 3.50	3514	49.00 \$

**UNC HSS Tin Kaplı
Makina Klavuzları
Düz Kanal DIN 371/376**

UNC 1/4x20	3700	3.70 \$
UNC 5/16x18	3701	4.30 \$
UNC 3/8x16	3702	5.30 \$
UNC 7/16x14	3703	7.30 \$
UNC 1/2x12	3704	7.50 \$
UNC 1/2x13	3705	7.50 \$
UNC 9/16x12	3706	9.60 \$
UNC 5/8x11	3707	10.45 \$
UNC 3/4x10	3708	18.70 \$
UNC 7/8x9	3709	22.50 \$
UNC 1x8	3710	34.00 \$

**UNF HSS Tin Kaplı İnce Diş
Makina Klavuzları
Düz Kanal DIN 371/376**

UNF 1/4x28	3750	3.70 \$
UNF 5/16x24	3751	4.30 \$
UNF 3/8x24	3752	5.30 \$
UNF 7/16x20	3753	7.30 \$
UNF 1/2x20	3754	7.50 \$
UNF 9/16x18	3755	9.60 \$
UNF 5/8x18	3756	10.45 \$
UNF 3/4x16	3757	18.70 \$

**UNF HSS Tin Kaplı İnce Diş
Makina Klavuzları
Helis Kanal DIN 371/376**

UNF 1/4x28	3811	4.50 \$
UNF 5/16x24	3812	5.35 \$
UNF 3/8x24	3813	5.90 \$
UNF 7/16x20	3814	7.80 \$
UNF 1/2x20	3815	8.30 \$
UNF 9/16x18	3816	10.30 \$
UNF 5/8x18	3817	12.30 \$
UNF 3/4x16	3818	18.15 \$
UNF 7/8x14	3819	25.50 \$
UNF 1x12	3820	38.50 \$

**UNC HSS Tin Kaplı
Makina Klavuzları 35 Derece
Helis Kanal DIN 371/376**

UNC 1/4x20	3800	4.50 \$
UNC 5/16x18	3801	5.35 \$
UNC 3/8x16	3802	5.90 \$
UNC 7/16x14	3803	7.80 \$
UNC 1/2x12	3804	8.30 \$
UNC 1/2x13	3805	8.30 \$
UNC 9/16x12	3806	10.30 \$
UNC 5/8x11	3807	12.30 \$
UNC 3/4x10	3808	18.15 \$
UNC 7/8x9	3809	25.50 \$
UNC 1x8	3810	38.50 \$

**UNC HSS 3'lü Takım
El Klavuzları**

UNC 1/8x40	3600	5.95 \$
UNC 5/12x32	3601	5.95 \$
UNC 3/16x24	3602	5.95 \$
UNC 1/4x20	3603	6.40 \$
UNC 5/16x18	3604	7.15 \$
UNC 3/8x16	3605	8.00 \$
UNC 7/16x14	3606	13.75 \$
BSW 1/2x12	3607	13.75 \$
UNC 1/2x13	3608	13.75 \$
UNC 9/16x12	3609	17.00 \$
UNC 5/8x11	3610	18.60 \$
UNC 3/4x10	3611	19.60 \$
UNC 7/8x9	3612	27.60 \$
UNC 1"x8"	3613	38.00 \$

**UNF HSS 3'lü Takım
İnce Diş El Klavuzları**

UNF 1/4x28	3650	6.40 \$
UNF 5/16x24	3651	7.15 \$
UNF 3/8x24	3652	8.15 \$
UNF 7/16x20	3653	13.75 \$
UNF 1/2x20	3654	13.75 \$
UNF 9/16x18	3655	17.00 \$
UNF 5/8x18	3656	18.60 \$
UNF 3/4x16	3657	19.60 \$

**HSS Gaz Diş 2'li Takım
El Klavuzları**

G 1/8x28	3850	9.00 \$
G 1/4x19	3851	13.50 \$
G 3/8x19	3852	20.50 \$
G 1/2x14	3853	29.00 \$
G 5/8x14	3854	42.00 \$
G 3/4x14	3855	55.00 \$
G 7/8x14	3856	65.00 \$
G 1x11	3857	80.00 \$

**HSS Gaz Diş Tekli
Makina Klavuzları DIN 5156**

G 1/8x28	3900	4.50 \$
G 1/4x19	3901	8.50 \$
G 3/8x19	3902	12.50 \$
G 1/2x14	3903	17.00 \$
G 5/8x14	3904	26.00 \$
G 3/4x14	3905	35.00 \$
G 7/8x14	3906	48.00 \$
G 1x11	3907	55.00 \$

**Metrik HSS-E Kobalt
Düz Makina Klavuzu
DIN 371C**

M3 x 0.50	3830	4.80 \$
M4 x 0.70	3831	4.80 \$
M5 x 0.80	3832	5.20 \$
M6 x 1.00	3833	6.20 \$
M8 x 1.25	3834	9.00 \$
M10 x 1.50	3835	12.00 \$

**Metrik HSS-E Kobalt
Düz Makina Klavuzu
DIN 376C**

M12 x 1.75	3836	19.00 \$
------------	------	----------

**Metrik HSS-E Kobalt
Helis Makina Klavuzu
DIN 371C**

M3 x 0.50	3837	5.00 \$
M4 x 0.70	3838	5.00 \$
M5 x 0.80	3839	5.50 \$
M6 x 1.00	3840	6.50 \$
M8 x 1.25	3841	9.50 \$
M10 x 1.50	3842	12.50 \$

**Metrik HSS-E Kobalt
Helis Makina Klavuzu
DIN 376C**

M12 x 1.75	3843	20.00 \$
------------	------	----------



HSS Helicoil Kılavuzu DIN 8141

M5 x 0.80	3770	4.30 \$
M6 x 1.00	3771	4.30 \$
M7 x 1.00	3772	5.50 \$
M8 x 1.00	3773	5.80 \$
M8 x 1.25	3774	5.80 \$
M10 x 1.00	3775	6.80 \$
M10 x 1.25	3776	6.50 \$
M10 x 1.50	3777	6.50 \$
M12 x 1.25	3778	7.50 \$
M12 x 1.50	3779	7.00 \$
M12 x 1.75	3780	7.00 \$
M14 x 1.25	3781	9.50 \$
M14 x 1.50	3782	9.50 \$
M16 x 1.50	3783	11.50 \$
M18 x 1.50	3784	14.00 \$
M20 x 1.50	3785	16.00 \$



HSS Gaz Diş Pafta DIN 5158

G 1/8x28	4130	10.00 \$
G 1/4x19	4131	13.00 \$
G 3/8x19	4132	21.00 \$
G 1/2x14	4133	26.00 \$
G 5/8x14	4134	36.00 \$
G 3/4x14	4135	39.00 \$
G 7/8x14	4136	65.00 \$
G 1x11	4137	69.00 \$



HSS Metrik Paftalar

ISO 2568 DIN 223/B

M3 x 0.5	4000	2.50 \$
M4 x 0.7	4001	2.50 \$
M5 x 0.8	4002	2.70 \$
M6 x 1.0	4003	3.20 \$
M8 x 1.25	4004	3.85 \$
M10 x 1.50	4005	7.50 \$
M12 x 1.75	4006	9.80 \$
M14 x 2.00	4007	9.80 \$
M16 x 2.00	4008	16.00 \$
M18 x 2.50	4009	17.00 \$
M20 x 2.50	4010	18.00 \$
M22 x 2.50	4011	29.00 \$
M24 x 3.00	4012	30.00 \$
M27 x 3.00	4013	43.00 \$
M30 x 3.50	4014	44.00 \$



HSS UNC Kalın Diş Pafta

UNC 1/4x20	4100	3.40 \$
UNC 5/16x18	4101	3.85 \$
UNC 3/8x16	4102	7.70 \$
UNC 7/16x14	4103	9.90 \$
BSW 1/2x12	4104	9.90 \$
UNC 1/2x13	4105	9.90 \$
UNC 9/16x12	4106	13.20 \$
UNC 5/8x11	4107	17.05 \$
UNC 3/4x10	4108	17.60 \$
UNC 7/8x9	4109	31.00 \$
UNC 1"x8	4110	32.00 \$



HSS Metrik Pafta İnce Diş

M8 x 1.0	4050	3.85 \$
M10 x 1.0	4051	7.50 \$
M10 x 1.25	4052	7.50 \$
M12 x 1.25	4053	9.80 \$
M12 x 1.50	4054	9.80 \$
M14 x 1.25	4055	9.80 \$
M14 x 1.50	4056	9.80 \$
M16 x 1.50	4057	16.00 \$
M18 x 1.25	4058	17.00 \$
M18 x 1.50	4059	17.00 \$
M20 x 1.50	4060	18.00 \$
M20 x 2.00	4061	18.00 \$
M22 x 1.50	4062	29.00 \$
M22 x 1.25	4063	29.00 \$



UNF HSS İnce Diş Pafta

UNF 1/4x28	4120	6.40 \$
UNF 5/16x24	4121	7.15 \$
UNF 3/8x24	4122	8.15 \$
UNF 7/16x20	4123	13.75 \$
UNF 1/2x20	4124	13.75 \$
UNF 9/16x18	4125	17.00 \$
UNF 5/8x18	4126	18.60 \$
UNF 3/4x16	4127	19.60 \$
UNF 7/8x14	4128	18.60 \$
UNF 1"x12	4129	19.60 \$



HELI-COIL Yaylar

	1.D	1.5 D	2. D	2.5 D	3. D
2.0 x 0.4 mm	0.86 €	1.11 €	1.29 €	1.45 €	1.82 €
2.5 x 0.45 mm	0.25 €	0.51 €	0.30 €	0.35 €	0.41 €
3.0 x 0.5 mm	0.25 €	0.51 €	0.30 €	0.35 €	0.41 €
3.0 x 0.6 mm	0.32 €	0.31 €	0.33 €	0.38 €	0.46 €
4.0 x 0.7 mm	0.25 €	0.51 €	0.30 €	0.35 €	0.41 €
5.0 x 8 mm	0.30 €	0.23 €	0.33 €	0.39 €	0.38 €
6.0 x 1 mm	0.31 €	0.25 €	0.38 €	0.46 €	0.56 €
7.0 x 1 mm	0.35 €	0.41 €	0.46 €	0.54 €	0.66 €
8.0 x 1 mm	0.38 €	0.38 €	0.46 €	0.54 €	0.66 €
8.0 x 1.25 mm	0.33 €	0.33 €	0.46 €	0.54 €	0.66 €
9.0 x 1.25 mm	0.46 €	0.61 €	0.61 €	0.68 €	0.79 €
10 x 1 mm	0.41 €	0.46 €	0.53 €	0.64 €	0.76 €
10 x 1.25 mm	0.41 €	0.46 €	0.53 €	0.64 €	0.76 €
10 x 1.50 mm	0.41 €	0.46 €	0.53 €	0.64 €	0.76 €
11 x 1.5 mm	0.69 €	0.78 €	0.84 €	1.02 €	1.14 €
12 x 1 mm	0.61 €	0.71 €	0.79 €	0.94 €	1.14 €
12 x 1.25 mm	0.61 €	0.71 €	0.79 €	0.94 €	1.14 €
12 x 1.5 mm	0.61 €	0.71 €	0.79 €	0.94 €	1.14 €
12 x 1.75 mm	0.61 €	0.71 €	0.79 €	0.94 €	1.14 €
14 x 1 mm	1.06 €	1.19 €	1.25 €	1.66 €	1.82 €
14 x 1.25 mm	0.87 €	1.00 €	1.04 €	1.25 €	1.52 €
14 x 1.5 mm	0.87 €	1.00 €	1.04 €	1.25 €	1.52 €
14 x 2 mm	0.87 €	1.00 €	1.04 €	1.25 €	1.52 €
16 x 1.5 mm	1.19 €	1.24 €	1.52 €	1.67 €	1.82 €
16 x 2 mm	1.19 €	1.24 €	1.52 €	1.67 €	1.82 €
18 x 1.5 mm	1.73 €	1.99 €	2.72 €	3.09 €	3.63 €
18 x 2 mm	1.73 €	1.99 €	2.72 €	3.09 €	3.63 €
18 x 2.5 mm	1.73 €	1.99 €	2.72 €	3.09 €	3.63 €
20 x 1.5 mm	1.99 €	2.54 €	3.27 €	3.63 €	4.17 €
20 x 2 mm	1.99 €	2.54 €	3.27 €	3.63 €	4.17 €
20 x 2.5 mm	1.99 €	2.54 €	3.27 €	3.63 €	4.17 €
22 x 1.5 mm	2.18 €	2.72 €	3.45 €	4.99 €	4.54 €
22 x 2 mm	2.18 €	2.72 €	3.45 €	3.99 €	4.54 €
22 x 2.5 mm	2.18 €	2.72 €	3.45 €	3.99 €	4.54 €
24 x 1.5 mm	3.72 €	2.90 €	3.63 €	4.36 €	5.08 €
24 x 2 mm	3.72 €	2.90 €	3.63 €	4.36 €	5.08 €
24 x 3 mm	3.72 €	2.90 €	3.63 €	4.36 €	5.08 €



HELI-COIL Buji

M14 x 1.25

8.4 mm
1.00 €

12.4 mm
1.00 €

16.4 mm
1.00 €

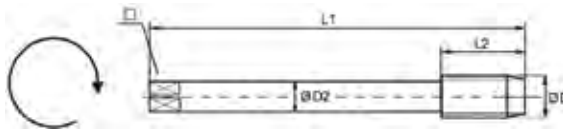

HELI-COIL Metrik İnce Diş Kılavuz

2.0 x 0.4 mm	12.20 €		
2.5 x 0.45 mm	12.20 €		
3.0 x 0.5 mm	10.73 €		
3.5 x 0.6 mm	10.73 €		
4.0 x 0.7 mm	10.73 €		
5.0 x 8 mm	10.73 €		
6.0 x 1 mm	10.73 €		
7.0 x 1 mm	13.37 €		
8.0 x 1 mm	13.37 €		
8.0 x 1.25 mm	13.37 €		
9.0 x 1.25 mm	16.50 €		
10 x 1 mm	16.50 €		
10 x 1.25 mm	16.50 €		
10 x 1.50 mm	16.50 €		
11 x 1.5 mm	18.40 €		
12 x 1 mm	22.61 €		
12 x 1.25 mm	22.61 €		
12 x 1.5 mm	22.61 €		
12 x 1.75 mm	18.48 €		
		14 x 1 mm	25.74 €
		14 x 1.25 mm	25.74 €
		14 x 1.5 mm	25.74 €
		14 x 2 mm	25.74 €
		16 x 1.5 mm	32.51 €
		16 x 2 mm	32.51 €
		18 x 1.5 mm	40.59 €
		18 x 2 mm	40.59 €
		18 x 2.5 mm	40.59 €
		20 x 1.5 mm	45.04 €
		20 x 2 mm	45.04 €
		20 x 2.5 mm	45.04 €
		22 x 1.5 mm	51.98 €
		22 x 2 mm	51.98 €
		22 x 2.5 mm	51.98 €
		24 x 1.5 mm	65.51 €
		24 x 2 mm	65.51 €
		24 x 3 mm	65.51 €



HELI-COIL M3-M12 Takım

B5101 260.- €
M3, M4, M5, M6, M8, M10, M12
Takıcı 7, Kırıcı 7, Matkap ucu 7,
Yay/Adet 15-15-15-15-15-10-10



HSS Torna Kalemleri

6x6x200 mm	3100	1.80 \$
8x8x200 mm	3102	3.00 \$
10x10x200 mm	3104	4.60 \$
12x12x200 mm	3106	6.00 \$
16x16x200 mm	3108	10.50 \$
20x20x200 mm	3110	17.00 \$



Trapez Keski Kalemleri (Zaviyeli)

1/2 - 3x12x160 mm	3160	4.00 \$
5/8 - 4x16x160 mm	3161	5.00 \$
3/4 - 5x20x160 mm	3162	6.00 \$
7/8 - 6x25x160 mm	3163	7.00 \$



HSS Yuvarlak Pantograf Kalemi

6x160 mm	3170	1.40 \$
8x160 mm	3171	2.30 \$
10x160mm	3172	3.60 \$
12x160 mm	3173	5.10 \$



Punta Matkap Ucu

1.6 mm	3198	1.20 \$
2.0 mm	3199	1.30 \$
2.5 mm	3200	1.60 \$
3.15 mm	3201	1.85 \$
4 mm	3202	2.55 \$
5 mm	3203	4.55 \$
6.3 mm	3204	8.00 \$
8 mm	3205	16.00 \$
10 mm	3206	23.00 \$



HSS Punta Matkap Ucu Uzun

2 mm	3192	3.00 \$
2.5 mm	3193	3.20 \$
3.15 mm	3194	4.30 \$
4.00 mm	3195	6.20 \$
5.00 mm	3196	9.50 \$
6.30 mm	3197	15.50 \$



Alüminyum Freze Uçları

5x8x80 mm (Normal)	2400	3.30 \$
5x8x120 mm (Uzun boy)	2401	4.45 \$
5x8x100 mm	2402	4.35 \$
5x8x60 mm (Kısa)	2403	2.75 \$
5x8x80 mm (HSS-E Cobalt)	2404	6.25 \$
5x6x80 mm (Arkası İnce)	2405	2.60 \$
5x6x60 mm (Arkası İnce Kısa)	2406	2.50 \$
5x6x100 mm (Arkası İnce Uzun)	2407	3.85 \$
5x6x120 mm (Arkası İnce Uzun)	2408	4.00 \$
6x8x80 mm (Ucu Kalın)	2409	3.40 \$
8x8x80 mm (Arkası Kalın Kısa)	2410	3.55 \$
8x8x100 mm (Arkası Kalın Normal)	2411	4.35 \$
8x8x120 mm (Arkası Kalın Uzun)	2412	4.50 \$
4x8x80 mm (Ucu İnce)	2413	3.45 \$
4x8x120 mm (İnce Uzun)	076190	3.45 \$



HSS-E CO Altın Seri %5 Kobaltlı Matkap Uçları

1.0 mm	1800	0.32 \$
1.5 mm	1801	0.38 \$
2.0 mm	1802	0.43 \$
2.5 mm	1803	0.60 \$
3.0 mm	1804	0.70 \$
3.2 mm	1805	0.80 \$
3.3 mm	1806	0.80 \$
3.5 mm	1807	0.90 \$
4.0 mm	1808	1.00 \$
4.2 mm	1809	1.10 \$
4.3 mm	1810	1.20 \$
4.5 mm	1811	1.20 \$
5.0 mm	1812	1.40 \$
5.2 mm	1813	1.50 \$
5.5 mm	1814	1.70 \$
6.0 mm	1815	2.00 \$
6.5 mm	1816	2.45 \$
6.7 mm	1817	3.00 \$
6.8 mm	1818	3.00 \$
7.0 mm	1819	3.00 \$
7.5 mm	1820	3.40 \$
8.0 mm	1821	4.00 \$
8.5 mm	1822	4.40 \$
8.7 mm	1823	5.20 \$
9.0 mm	1824	5.20 \$
9.5 mm	1825	5.80 \$
10.0 mm	1826	6.70 \$
10.2 mm	1827	7.30 \$
10.5 mm	1828	7.30 \$
11.0 mm	1829	8.50 \$
11.5 mm	1830	9.20 \$
12.0 mm	1831	10.50 \$
12.5 mm	1832	11.50 \$
13.0 mm	1833	13.00 \$
13.5 mm	1834	18.50 \$
14.0 mm	1835	19.50 \$
14.5 mm	1836	22.00 \$
15.0 mm	1837	23.00 \$
15.5 mm	1838	24.50 \$
16.0 mm	1839	26.50 \$
16.5 mm	1840	28.00 \$
17.0 mm	1841	30.00 \$
17.5 mm	1842	32.00 \$
18.0 mm	1843	34.00 \$
18.5 mm	1844	37.00 \$
19.0 mm	1845	39.50 \$
19.5 mm	1846	42.00 \$
20.0 mm	1847	48.00 \$

Kademeli Matkap (Flute Drill Bit)

4 - 16 mm	MU1573	4.95 \$
4 - 20 mm	MU1574	5.00 \$
4 - 30 mm	MU1576	8.10 \$
6 - 50 mm	MU1577	28.50 \$



Kademeli Matkap Seti MU1578 20.- \$

4-12 mm, 4-20 mm, 4-30 mm



Kademeli Matkap

4 - 12 mm	2420	3.00 \$
4 - 20 mm	2421	4.40 \$
4 - 30 mm	2422	8.00 \$
4 - 32 mm	2423	8.80 \$
4 - 39 mm	2424	16.50 \$
6 - 52 mm	2425	25.50 \$



Kademeli Matkap Ucu Seti

3lü set, 4-12 mm, 4-20 mm, 4-32 mm
2426 17.80 \$



HSS Metal Matkap Ucu Uzun DIN 340

1.0 x 56 mm	1745	0.33 \$
1.5 x 70 mm	1746	0.33 \$
2.0 x 85 mm	1747	0.36 \$
2.5 x 95 mm	1748	0.38 \$
3.0 x 100 mm	1749	0.53 \$
3.5 x 110 mm	1748	0.58 \$
4.0 x 119 mm	1751	0.62 \$
4.2 x 119 mm	1752	0.64 \$
4.5 x 126 mm	1753	0.73 \$
5.0 x 132 mm	1754	0.85 \$
5.5 x 139 mm	1755	1.00 \$
6.0 x 139 mm	1756	1.08 \$
6.5 x 148 mm	1757	1.31 \$
7.0 x 156 mm	1758	1.52 \$
7.5 x 156 mm	1759	1.70 \$
8.0 x 165 mm	1760	1.92 \$
8.5 x 165 mm	1761	2.20 \$
9.0 x 175 mm	1762	2.45 \$
9.5 x 175 mm	1763	2.75 \$
10.0 x 184 mm	1764	3.10 \$



Kaporta Punta Çürütme Matkap Ucu

6 mm	3188	2.50 \$
7 mm	3189	2.90 \$
8 mm	3190	4.00 \$

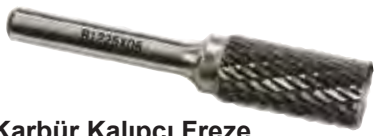

Karbür Kalıpcı Freze A Tip - Silindir Düz

A6 x 16 x 06	3210	4.00 \$
A8 x 20 x 06	3211	5.30 \$
A10 x 20 x 06	3212	6.60 \$
A12 x 25 x 06	3213	10.00 \$
A16 x 25 x 06	3214	17.50 \$



Karbür Kalıpcı Freze B Tip Alın Kesmeli - Silindir Düz

B6 x 16 x 06	3215	4.00 \$
B8 x 20 x 06	3216	5.30 \$
B10 x 20 x 06	3217	6.60 \$
B12 x 25 x 06	3218	10.00 \$
B16 x 25 x 06	3219	17.50 \$



Karbür Kalıpcı Freze C Tip - Silindir Oval Başlı

C6 x 20 x 06	3220	4.00 \$
C8 x 20 x 06	3221	4.00 \$
C10 x 20 x 06	3222	6.60 \$
C12 x 25 x 06	3223	10.00 \$
C16 x 25 x 06	3224	17.50 \$



Karbür Kalıpcı Freze D Tip - Küre Başlı

D6 x 05 x 06	3225	3.65 \$
D8 x 07 x 06	3226	5.00 \$
D10 x 09 x 06	3227	6.20 \$
D12 x 10 x 06	3228	9.00 \$
D16 x 14 x 06	3229	16.00 \$



Karbür Kalıpcı Freze E Tip - Silindir Oval Başlı

E6 x 10 x 06	3230	3.65 \$
E8 x 13 x 06	3231	5.00 \$
E10 x 16 x 06	3232	6.20 \$
E12 x 20 x 06	3233	9.00 \$
E16 x 25 x 06	3234	16.00 \$



Karbür Kalıpcı Freze F Tip - Küre Uçlu Çam

F6 x 18 x 06	3235	3.65 \$
F8 x 20 x 06	3236	5.00 \$
F10 x 20 x 06	3237	6.20 \$
F12 x 25 x 06	3238	8.30 \$
F16 x 25 x 06	3239	16.00 \$



Karbür Kalıpcı Freze G Tip - Sivri Çam

G6 x 18 x 06	3240	3.65 \$
G8 x 20 x 06	3241	5.00 \$
G10 x 20 x 06	3242	6.20 \$
G12 x 25 x 06	3243	9.00 \$
G16 x 25 x 06	3244	16.00 \$



Karbür Kalıpcı Freze H Tip - Alev Uçlu

H6 x 18 x 06	3245	4.00 \$
H8 x 20 x 06	3246	5.30 \$
H10 x 20 x 06	3247	6.60 \$
H12 x 32 x 06	3248	10.00 \$
H16 x 36 x 06	3249	17.50 \$



Karbür Kalıpcı Freze M Tip - Konik Sivri

M6 x 18 x 06	3255	3.65 \$
M8 x 20 x 06	3256	5.00 \$
M10 x 20 x 06	3257	6.20 \$
M12 x 25 x 06	3258	9.00 \$
M16 x 25 x 06	3259	16.00 \$



Karbür Kalıpcı Freze L Tip - Konik Yuvarlak

L6 x 16 x 06	3250	3.65 \$
L8 x 22 x 06	3251	5.00 \$
L10 x 22 x 06	3252	6.20 \$
L12 x 25 x 06	3253	9.00 \$
L16 x 33 x 06	3254	16.00 \$



HSS Küre Form Havşa Freze Ucu (M2 Çelik Malzemedn)

4 mm	53380	1.60 \$
5 mm	53381	1.60 \$



HSS 4 Ağız Standart Parmak Freze

3 mm	2800	3.25 \$
4 mm	2801	3.25 \$
5 mm	2802	3.45 \$
6 mm	2803	3.45 \$
7mm	2804	5.20 \$
8 mm	2805	5.20 \$
9 mm	2826	6.60 \$
10 mm	2807	6.70 \$
12 mm	2809	9.10 \$
14 mm	2811	10.90 \$
15 mm	2812	12.00 \$
16 mm	2813	12.30 \$
18 mm	2815	14.40 \$
20 mm	2817	19.50 \$
22 mm	2818	23.00 \$
24 mm	2819	30.70 \$
26 mm	2821	38.00 \$

HSS 4 Ağız Uzun Parmak Freze

3 mm	2850	4.10 \$
4 mm	2851	4.10 \$
5 mm	2852	4.50 \$
6 mm	2853	4.50 \$
8 mm	2854	7.65 \$
10 mm	2855	8.00 \$
12 mm	2856	12.35 \$
14 mm	2857	14.70 \$
16 mm	2858	18.00 \$
18 mm	2859	20.70 \$
20 mm	2860	27.75 \$
22 mm	2861	32.25 \$
30 mm	2865	64.00 \$



HSS 4 Ağızlı Kabatalaş Parmak Freze

6 mm	2950	9.50 \$
7 mm	2951	10.00 \$
8 mm	2952	10.30 \$
10 mm	2953	11.50 \$
12 mm	2954	13.50 \$
14 mm	2955	16.70 \$
16 mm	2956	18.50 \$
18 mm	2957	22.00 \$
20 mm	2958	25.50 \$
22 mm	2959	37.30 \$
25 mm	2960	45.00 \$
28 mm	2961	58.00 \$
30 mm	2962	67.50 \$
32 mm	2963	75.30 \$
34 mm	2964	85.00 \$
35 mm	2965	88.00 \$



4 Ağızlı Karbür Elmas Parmak Freze

1 mm	3050	3.70 \$
1.5 mm	3051	3.70 \$
2 mm	3052	3.70 \$
2.5 mm	3053	3.70 \$
3 mm	3054	3.70 \$
4 mm	3055	3.70 \$
5 mm	3056	6.80 \$
6 mm	3057	7.80 \$
8 mm	3059	12.50 \$
10 mm	3061	19.00 \$
12 mm	3063	26.00 \$
14 mm	3065	48.00 \$
16 mm	3066	59.00 \$
18 mm	3067	70.00 \$
20 mm	3068	95.00 \$



4 Ağızlı Küresel Karbür Elmas Parmak Freze

3 mm	3080	6.00 \$
4 mm	3081	6.00 \$
5 mm	3082	10.00 \$
6 mm	3083	10.00 \$
8 mm	3084	17.00 \$
10 mm	3085	24.00 \$
12 mm	3086	32.00 \$
14 mm	3087	63.00 \$
16 mm	3088	75.00 \$



HSS 2 Ağız Parmak Freze

3 mm	3000	3.30 \$
4 mm	3001	3.30 \$
5 mm	3002	3.45 \$
6 mm	3003	3.45 \$
8 mm	3004	4.85 \$
10 mm	3005	6.60 \$
12 mm	3006	8.50 \$
14 mm	3007	10.20 \$
16 mm	3008	11.70 \$
18 mm	3009	13.50 \$
20 mm	3010	17.50 \$
22 mm	3011	21.50 \$



Metal Kumpas

150x0.02 mm	1003	8.55 \$
150x0.05 mm	1004	8.55 \$
150x0.02 mm	MU2550	10.90 \$
200x0.02 mm	1005	14.50 \$
300x0.05 mm	1007	25.00 \$
300x0.05 mm Uzun çift Çeneli	1040	58.50 \$
500x0.05 mm	1041	92.00 \$
1000x0.05 mm	1043	238.00 \$
100x0.05 mm cep tipi	1002	8.55 \$

Ekonomik Kumpas

150x0.5 mm	1000	5.85 \$
------------	------	---------



150 mm Saatli Kumpas	1100	21.00 \$
200 mm Saatli Kumpas	1101	32.00 \$



Dijital Kumpas (Büyük Ekran)

100x0.01 mm	1050	19.00 \$
150x0.01 mm	1051	19.00 \$
200x0.01 mm	1052	30.00 \$
300x0.01 mm	1053	48.00 \$
500x0.01 mm	1054	135.00 \$



Dijital Kumpas Metal Ekran

150x0.01 mm	1060	22.50 \$
200x0.01 mm	1061	33.50 \$
300x0.01 mm	1062	50.50 \$



Dijital Kumpas Mitutoyo Model	1070	34.00 \$
-------------------------------	------	----------



Mekanik Metal Kumpas Uzun Tek Çene

500x0.05 mm - 100mm çene	1008	47.00 \$
600x0.05 mm - 100 mm çene	1009	50.00 \$
1000x0.05 mm - 125mm çene	1010	150.00 \$
1500x0.05 mm - 150mm çene	1011	320.00 \$



Mikrometre

0-25 x 0.01 mm	1150	10.80 \$
25-50 x 0.01 mm	1151	13.45 \$
50-75 x 0.01 mm	1152	15.85 \$
75-100 x 0.01 mm	1153	18.50 \$
100-125 x 0.01 mm	1154	21.3 \$
125-150 x 0.01 mm	1155	23.70 \$
150-175 x 0.01 mm	1156	27.20 \$
175-200 x 0.01 mm	1157	30.30 \$



Dijital Mikrometre

0-25 x 0.01 mm	1190	70.50 \$
25-50 x 0.01 mm	1191	82.50 \$
50-75 x 0.01 mm	1192	97.00 \$
75-100 x 0.01 mm	1193	110.00 \$



Numeratörlü Mikrometre

0-25 mm	1185	34.40 \$
25-50 mm	1186	37.40 \$



Magnetic Ayak

64x50x54 mm	1380	12.00 \$
-------------	------	----------

Magnetic Yatak

100x70x96 mm	1390	86.00 \$
--------------	------	----------



Kulaklı Komperatör Saati 0-10 / 0.1,	1300	11.45 \$
Kulaksız Komperatör Saati 0-10 / 0.1	1301	11.45 \$
Komperatör Saati Uzun Çubuklu	1305	23.80 \$



Salgı Komperatör Saati

0.08 mm x 0.01	1310	30.00 \$
----------------	------	----------

Salgı Komperatör Saati Uzun Çubuklu

0.08 mm x 0.01 - 30 mm	1311	36.50 \$
------------------------	------	----------



Dijital Komperatör Saati

0.127 mm/0.01 1320 29.00 \$



Cep Tipi Kalınlık Komparatörü

0-10 x 0.1 x 15 mm 1325 10.50 \$
0-10 x 0.1 x 20 mm 1326 12.85 \$



Boru Kalınlık Komparatörü

0-10 x 0.01 x 30 mm 1330 33.00 \$



Rulmanlı Kalınlık Komparatörü

0-10 x 0.01 x 100 mm 1335 115.60 \$



İç Çap Komparatörü

15-35 x 0.01 mm 1340 100.00 \$
35-55 x 0.01 mm 1341 100.00 \$
55-75 x 0.01 mm 1342 100.00 \$



Silindir Komparatör Takımı

10-18 x 0.01 mm 1350 94.00 \$
18-35 x 0.01 mm 1351 60.40 \$
35-50 x 0.01 mm 1352 60.40 \$
50-160 x 0.01 mm 1353 67.80 \$
160-250 x 0.01 mm 1354 70.00 \$



Manyetik Gönye

100 mm, 22 kg 80955 7.00 \$

Manyetik Gönye

127 mm, 33 kg 80960 14.75 \$

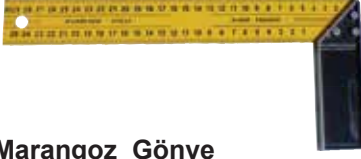

Marangoz Gönye

250 mm	MK0390	1.50 \$
300 mm	MK0391	1.60 \$
350 mm	MK0392	1.70 \$
400 mm	MK0393	1.80 \$
500 mm	MK0394	1.95 \$
600 mm	MK0395	2.20 \$



Alüminyum Gönye

250 mm	MK0400	4.20 \$
300 mm	MK0401	4.60 \$
350 mm	MK0402	5.35 \$
400 mm	MK0403	5.45 \$
500 mm	MK0404	6.20 \$
600 mm	MK0405	6.90 \$



Ayarlı Gönye

300 mm 81231



Ayarlı Marangoz Gönye

250 mm 81210 0.76 \$



Mıknatıslı Açı Ölçer

BTS 12103



Mekanik Prop

Tin Kaplı	1424	8.50 \$
Sarı	1425	5.00 \$



Işık Sesli Prop

20x160 mm 1426 34.15 \$



Açılı Ayarlı Tesviyeci Gönye

80x120 mm	1430	12.20 \$
120x150 mm	1431	14.40 \$
150x200 mm	1432	15.10 \$



Dereceli Mercekli Gönye

0-10 x 0.01 mm 1450 43.30 \$
0-360 derece, 3 parça



Tesviyeci Düz Gönye

DIN 875/1

50 x 75	80803	8.00 \$
70 x 100	1470	8.45 \$
100 x 150	1471	11.00 \$
130 x 200	1472	17.00 \$
165 x 250	80807	39.84 \$
200 x 300	80808	47.95 \$

Tesviyeci Şapkalı Gönye

DIN 875/1

50 x 75	80813	9.80 \$
70 x 100	1480	9.80 \$
100 x 150	1481	14.00 \$
130 x 200	1482	18.50 \$
165 x 250	1483	27.50 \$
200 x 300	1484	36.50 \$
250 x 400	1485	63.00 \$
500 x 330	1486	110.00 \$



Kıl Gönye DIN 875/1

70 x 100	1460	11.00 \$
100 x 150	1461	16.00 \$
130 x 200	1462	22.00 \$



Johnson Master Seti

47 parça set	1370	133.- \$
87 parça set	1371	215.- \$
112 parça set	1372	310.- \$

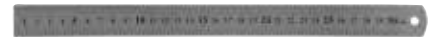

Çelik Cetvel

150 mm x 17 mm	81510	1.30 \$
300 mm x 25 mm	81520	1.80 \$
500 mm x 26 mm	81530	4.75 \$
1000 mm x 30 mm	81540	11.50 \$



Dış Tarağı

1420 8.50 \$
52 parça metrik ve inch kombine set



Radius Masterı

1.0 x 7.0 x 0.5 mm	1400	7.80 \$
7.5 x 15 x 0.5 mm	1401	7.80 \$
15.5 x 25 x 0.5 mm	1402	7.80 \$



Sentil Filler Çakı (20 Yaprak)

20'li metrik	1410	2.25 \$
20'li uzun	1411	2.25 \$



Mercekli Yükseklik Mihengiri

0-300 x 0.02 mm	1240	77.00 \$
0-500 x 0.02 mm	1241	124.00 \$
0-600 x 0.02 mm	1242	135.00 \$



Dijital Yükseklik Mihengiri (Çift Kolonlu)

0-300 x 0.01 mm	1260	362.00 \$
0-500 x 0.01 mm	1261	492.00 \$
0-600 x 0.01 mm	1262	575.00 \$

Saatli Yükseklik Mihengiri

0-300 x 0.01 mm	1250	206.00 \$
0-500 x 0.01 mm	1251	260.00 \$
0-600 x 0.01 mm	1252	350.25 \$



Döner Puntalar (Hassas Tip)

1 Mors, 115 mm	21.00 \$
2 Mors, 130 mm	27.00 \$
3 Mors, 170 mm	34.00 \$
4 Mors, 210 mm	42.00 \$
5 Mors, 268 mm	58.00 \$



Mors Konikler

2 Mors B10	23661	3.25 \$
3 Mors B12	23665	4.60 \$
3 Mors B16	23666	4.10 \$
4 Mors B16	23667	6.40 \$
3 Mors B18	23668	4.00 \$
4 Mors B18	23671	6.70 \$
4 Mors B20		8.00 \$
3 Mors B22	23672	5.20 \$
4 Mors B22	23673	6.80 \$
4 Mors B24	23674	8.30 \$



Mors Kovanlar

3/2	23681	4.50 \$
4/3	23686	7.60 \$
4/2	23687	7.60 \$
5/4	23691	16.00 \$
5/3	23692	16.00 \$

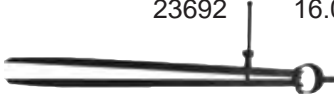

Pegel Düz

150 mm	81610	5.58 \$
200 mm	81611	6.71 \$
250 mm	81612	8.00 \$
300 mm	81613	10.42 \$

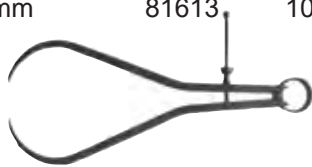

Pegel Dış Çap

300 mm		10.42 \$
--------	--	----------

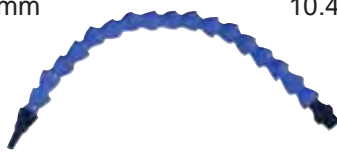

Bor Yağ Hortumu

Düz ağız 1/2	96.00 TL
Düz ağız 1/4	61.00 TL
Düz ağız 3/8	96.00 TL
Düz ağız 3/4	279.00 TL

Bor Yağ Hortumu

Ördek ağız 1/2	96.00 TL
Ördek ağız 1/4	61.00 TL
Ördek ağız 3/8	96.00 TL
Ördek ağız 3/4	279.00 TL



Turmetre	81951	5.85 \$
5 haneli, çarpmalı		



Dönerli Matkap, Freze Mengenesi

125 mm	210.- \$
160 mm	285.- \$



İki Açılı Planya, Freze Mengenesi

125 mm	265.- \$
--------	----------



Süper Hassas Tezgaah Mengenesi

175x200 mm	820.- \$
175x300 mm	890.- \$
200x300 mm	1 345.- \$



Kalıp Markalama Boyası

Kırmızı, 115 cc	27054	2.45 \$
Mavi, 115 cc	27055	2.45 \$

Koli Adedi:20



Metal Bor Yağ Hortumu

Nokta Uç, 300 mm, 1/4"	310.00 TL
Nokta Uç, 300 mm, 3/8"	314.00 TL
Nokta Uç, 300 mm, 1/2"	317.40 TL
Nokta Uç, 400 mm, 1/4"	338.00 TL
Nokta Uç, 400 mm, 3/8"	341.00 TL
Nokta Uç, 400 mm, 1/2"	345.00 TL
Nokta Uç, 500 mm, 1/4"	369.00 TL
Nokta Uç, 500 mm, 3/8"	372.00 TL
Nokta Uç, 500 mm, 1/2"	376.00 TL
Nokta Uç, 600 mm, 1/4"	397.00 TL
Nokta Uç, 600 mm, 3/8"	400.00 TL
Nokta Uç, 600 mm, 1/2"	403.00 TL
Nokta Uç, 700 mm, 1/4"	427.00 TL
Nokta Uç, 700 mm, 3/8"	430.00 TL
Nokta Uç, 700 mm, 1/2"	433.00 TL



Torna Aynasından Anahtar

80 mm	6.50 \$
100 mm	6.50 \$
125 mm	9.50 \$
160 mm	12.50 \$
200 mm	16.00 \$
250 mm	16.00 \$
315 mm	20.00 \$
400 mm	27.00 \$
500 mm	29.00 \$



3 Ayaklı Torna Aynası

Ø 50, 3 Ayaklı	75.00 \$
Ø 60, 3 Ayaklı	88.00 \$
Ø 80, 3 Ayaklı	73.00 \$
Ø 100, 3 Ayaklı	81.00 \$
Ø 125, 3 Ayaklı	92.00 \$
Ø 160, 3 Ayaklı	133.00 \$
Ø 200, 3 Ayaklı	178.00 \$
Ø 250, 3 Ayaklı	245.00 \$
Ø 315, 3 Ayaklı	497.00 \$
Ø 400, 3 Ayaklı	750.00 \$
Ø 500, 3 Ayaklı	1 450.00 \$



4 Ayaklı Torna Aynası

Ø 100, 4 Ayaklı	110.00 \$
Ø 125, 4 Ayaklı	114.00 \$
Ø 160, 4 Ayaklı	163.00 \$
Ø 200, 4 Ayaklı	220.00 \$
Ø 250, 4 Ayaklı	315.00 \$
Ø 315, 4 Ayaklı	563.00 \$



Torna Aynası Pinyon Dişli

80 mm	6.00 \$
100 mm	7.00 \$
125 mm	8.00 \$
160 mm	9.00 \$
200 mm	10.00 \$
250 mm	11.00 \$
315 mm	13.00 \$
400 mm	19.00 \$
500 mm	28.00 \$



Torna Aynası Spiral Dişli

80 mm	20.00 \$
100 mm	23.00 \$
125 mm	30.00 \$
160 mm	42.00 \$
200 mm	58.00 \$
250 mm	85.00 \$
315 mm	140.00 \$
400 mm	290.00 \$
500 mm	320.00 \$



WNMG 080408 4.80 €
WNMG 160408 Çin 60.00 TL



DCMT 070202 3.15 €
DCMT 11T308 4.20 €



DNMG 150608 NM1 6.30 €

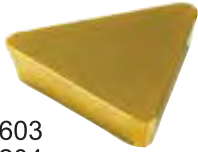

TPKN 1603 4.35 €
TPKN 2204 5.65 €
TPKN 1603 Çin 30.00 TL
TPKN 220408 Çin 30.00 TL



APKT 1003PDR 4.35 €
APKT 1604PDR 6.05 €

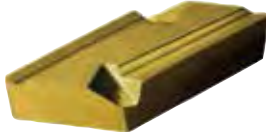

KNUX 160405 R 5.50 €
KNUX 160405 L 5.50 €
KNUX 160405 R - Çin 32.00 TL
KNUX 160405 L - Çin 32.00 TL

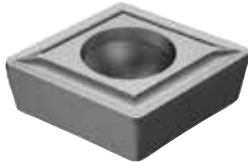

CCMT 09T308 4.05 €
CCMT 120408 4.60 €
CCMT 09T304 Çin 47.00 TL

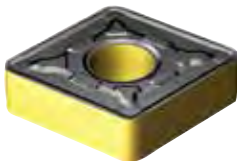

CNMG 120408 NM 4.80 €
CNMG 160616 8.10 €
CNMG 190612 10.75 €
CNMG 120408 Çin 57.- TL
CNMG 190612 Çin 85.- TL

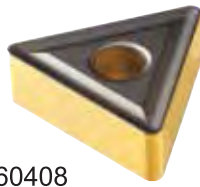

TNMG 160408 4.80 €
TNMG 160408 Çin 53.00 TL

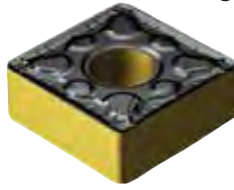

SNMG 120408NF1 4.80 €
SNMG 120412 Çin 51.00 TL

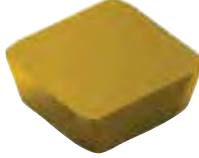

SPKN 1203 EDR Çin 47.50 TL

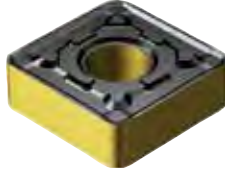

SNMG 190616 Çin 76.00 TL



S25S MWLNR 1260.00 TL
S25S MWLNL 1260.00 TL



S16Q SDUCR 7 645.00 TL



S25S DDUNR 15 1260.00 TL
S32T DDUNR 15 1555.00 TL



TBAP16 - 90D - 100-8 2835.00 TL
TBAP16 - 90D - 125-10 4200.00 TL



TBTP22 - 90D - 80-4 2635.00 TL
TBTP22 - 90D - 100-5 2945.00 TL
TBTP16 - 90D - 100-6 3240.00 TL



CKJNR 2525 945.00 TL/Adet
CKJNL 2525 945.00 TL/Adet



MWLNR 2525 1135.00 TL/Adet
MWLNL 2525 1135.00 TL/Adet



MTJNR 2525 1135.00 TL/Adet
MTJNL 2525 1135.00 TL/Adet



SCLCR 2525 890.00 TL/Adet
SCLCR 2525 890.00 TL/Adet



DDNNN 2525 M15 1135.00 TL/Adet



DDJNR 2525 1320.00 TL/Adet
DDJNL 2525 1320.00 TL/Adet



DWLNL 2525 M8 1135.00 TL/Adet



PCLNR 2020K 12 1155.00 TL/Adet

Üçgen Slim Eğe

4" - 100 mm	MK0900	0.640 \$
5" - 125 mm	MK0902	0.940 \$
6" - 150 mm	MK0904	0.960 \$
7" - 175 mm	MK0906	0.113 \$
8" - 200 mm	MK0908	0.130 \$

Üçgen Regular Eğe

5" - 125 mm	MK0910	1.22 \$
6" - 150 mm	MK0912	1.48 \$
7" - 175 mm	MK0914	2.00 \$
8" - 200 mm	MK0916	2.10 \$

Yassı Eğe Orta Diş

6" - 150 mm	MK0920	1.51 \$
8" - 200 mm	MK0922	2.02 \$
10" - 250 mm	MK0924	2.98 \$
12" - 300 mm	MK0926	4.00 \$

Yassı Eğe Kalın Diş

6" - 150 mm	MK0928	1.51 \$
8" - 200 mm	MK0930	2.02 \$
10" - 250 mm	MK0932	2.98 \$
12" - 300 mm	MK0934	4.00 \$

Balık Sırtı Ağaç Törpü Saplı

8" - 200 mm	MK0990	2.36 \$
10" - 250 mm	MK1000	3.08 \$
12" - 350 mm	MK1002	3.40 \$

Motor Eğesi, Yuvarlak Eğe

5/32 - 4. mm	MK1010	1.33 \$
3/16 - 4.8 mm	MK1020	1.33 \$
7/32 - 5.5 mm	MK1030	1.33 \$

Plastik Eğe Sapı

No: 1	60010	0.50 \$
No: 2	60011	0.75 \$
No: 3	60012	1.00 \$

Ağaç Eğe Sapı

Küçük
Büyük

Mini Eğe Seti

6 parça - 5x180 mm	145	6.10 \$
--------------------	-----	---------

Eğe Seti

5 parça	1290	11.50 \$
---------	------	----------



Alüminyum Eğe Kolu 15.10 €
60006



Alüminyum Eğe 14" 8.64 €
60005



Saatçi Elmas Eğe Takımı 6.00 \$
5 Parça - 160 mm 11.65 \$
10 Parça



Raspa Seti 19.50 €
Promo 2 - eko 60310

Raspa Tutucu 7.20 €
60301



Raspa C-20 Yedek Bıçak 13.55 €
Kısa 60305
Uzun 60304

Metal Çizici Kalem 2.60 \$



Mini Eğe Seti 4.80 \$
MK1036
6 parça - 4x140 mm



Eğe Seti 13.70 \$
MK1040
5 parça, 8"



HSS Havşa Freze 3 Ağız

8.3 mm	3174	4.60 \$
10.4 mm	3175	5.40 \$
12.4 mm	3176	5.90 \$
16 mm	3177	6.80 \$
16.5 mm	3178	6.80 \$
20 mm	3179	8.60 \$
20.5 mm	3180	8.90 \$
25 mm	3181	12.40 \$
25.5 mm	3182	12.40 \$
30 mm	3183	18.35 \$
31.5 mm	3184	19.35 \$
35 mm	3185	27.00 \$
40 mm	3186	31.00 \$
50 mm	3187	47.00 \$



Kalıp Bağlama Seti 52 Parça

M10 x 1.25 mm	63.00 \$
M12 x 1.75 mm	77.50 \$
M14 x 2.00 mm	84.00 \$
M16 x 2.00 mm	97.00 \$
M18 x 2.50 mm	210.00 \$



Çelik Rakam Takımları

3 mm	60223	12.10 €
4 mm	60424	12.60 €
5 mm	60425	15.50 €
6 mm	60426	16.10 €
8 mm	60428	19.60 €
10 mm	60430	27.16 €

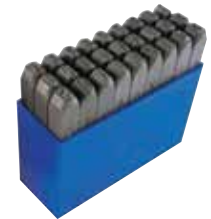

Çelik Harf Takımları

3 mm	60403	33.00 €
4 mm	60404	35.80 €
5 mm	60405	38.40 €
6 mm	60406	42.40 €
8 mm	60408	59.15 €
10 mm	60410	75.50 €



Pens OZ, DIN 6388 - B, ISO 10897

Sıkma Kapasitesi 0.5 mm,
Sertlik 44 - 49 HRC,
Salgı Değerleri DIN 6388,
462 E

D=35.05 mm / L=52 mm
3-2.5 mm
4-3.5 mm
5-4.5 mm
6-5.5 mm
8-7.5 mm
10-9.5 mm
12-11.5 mm
14-13.5 mm
15-14.5 mm
16-15.5 mm
18-17.5 mm
20-19.5 mm
21-20.5 mm
22-21.5 mm
23-22.5 mm
24-23.5 mm
25-24.5 mm

467 E

D= 43.7 mm / L=60 mm
3-2.5 mm
4-3.5 mm
5-4.5 mm
6-5.5 mm
8-7.5 mm
10-9.5 mm
12-11.5 mm
14-13.5 mm
15-14.5 mm
16-15.5 mm
18-17.5 mm
20-19.5 mm
22-21.5 mm
24-23.5 mm
25-24.5 mm
26-25.5 mm
28-27.5 mm
30-29.5 mm
32-31.5 mm



Revolver Pensleri (DIN 6343)

A15	A42
Yuvarlak	Yuvarlak
Altıköşe	Altıköşe
Kare	Kare
A25	A60
Yuvarlak	Yuvarlak
Altıköşe	Altıköşe
Kare	Kare
A30	Elgo 16
Yuvarlak	Yuvarlak
Altıköşe	Altıköşe
Kare	Kare

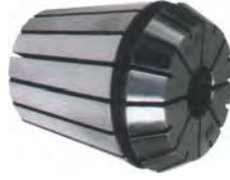

Pens ER, DIN 6499 - B, ISO 15488

Sıkma Kapasitesi 1 mm,
Sertlik 44 - 49 HRC,
Salgı Değerleri DIN 6499

ER 16

D:17 mm / L=27.5 mm
2-1 mm
3-2 mm
4-3 mm
5-4 mm
6-5 mm
8-7 mm
10-9 mm

ER 25

D:26 mm / L=34 mm
E 2-1 mm
3-2 mm
4-3 mm
5-4 mm
6-5 mm
8-7 mm
10-9 mm
12-11 mm
14-13 mm
15-14 mm
16-15 mm

ER 32

D:33 mm / L=40 mm
3-2 mm
4-3 mm
5-4 mm
6-5 mm
8-7 mm
10-9 mm
12-11 mm
14-13 mm
15-14 mm
16-15 mm
18-17 mm
19-18 mm
20-19 mm

ER 40

D:41 mm / L=46 mm
3-2 mm
4-3 mm
5-4 mm
6-5 mm
8-7 mm
10-9 mm
12-11 mm
14-13 mm
15-14 mm
16-15 mm
18-17 mm
20-19 mm
22-21 mm
24-23 mm
25-24 mm
26-25 mm



ER 20

D:26 mm / L=34 mm
2-1.5 mm
3-2 mm
4-3 mm
5-4 mm
6-5 mm
7-6 mm
8-7 mm
9-8 mm
10-9 mm
11-10 mm
12-11 mm
13-12 mm

ER PENS KAPAKLARI

ER16.K 1-10mm
ER20 1-13mm
ER25 1-16mm
ER32 2-20mm
ER40 3-26mm



ISO Pens Takımı DIN 2080 / ISO 2583 OZ DIN 6388 - B, ISO 10987, 16 Parça

150 30, 4 - 25 mm
150 40, 4 - 25 mm
150 40, 5 - 32 mm
150 50, 5 - 32 mm

ER DIN 6499 - B, ISO 15488, 16 Parça

150 30, 3 - 20 mm
150 40, 3 - 20 mm
150 40, 4 - 26 mm
150 50, 4 - 26 mm



MK Pens Takımı DIN 228 A/B OZ DIN 228 Form A DIN 6388 - B, ISO 10897, 16 Parça

MK 3, 4 - 25 mm
MK 4, 4 - 25 mm
MK 4, 5 - 32 mm
MK 5, 4 - 25 mm
MK 5, 5 - 32 mm

OZ DIN 228 Form B DIN 6388 - B, ISO 10897, 16 Parça

MK 3, 4 - 25 mm
MK 4, 4 - 25 mm
MK 4, 5 - 32 mm
MK 5, 4 - 25 mm
MK 5, 5 - 32 mm



Kod/Code	Boy/Size	a	b	c	d	e	f	g	h	i	k	l	m	n	o	α
310-2	2	7	50	20	5.5	24	10	26	26	12	5.5	12	31	4.5	4.75	115°
310-3	3	9	75	24	5.5	29	27	26	35	16	6	15	37	5.5	3.75	90°
310-4	4	13	130	40	8.5	61	30	-	55	20	9	22	39	4	12	125°

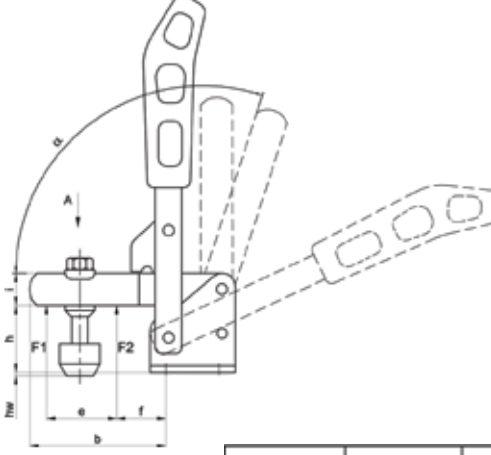

Kod Code	Boy Size	F1 (N)	F2 (N)	Diagram		hw	Diagram	g
310-2	2	1000	1200	145	75	-3 / 8	M5 x 35	177
310-3	3	1800	2500	183	110	-2 / 8	M8 x 45	380
310-4	4	2000	3000	237	182	3 / 29	M8 x 70	900

310 Düz Tabanlı Dikey Sıkma Takımları

310 - 2	(Czmk 800-2)	(Kukomed 211-2)	23565	375.00 TL
310 - 3	(Czmk 800-2)	(Kukomed 211-3)	23566	481.00 TL
310 - 4	(Czmk 800-3)	(Kukomed 211-4)	23567	597.00 TL

Kod/Code	Boy/Size	a	b	c	d	e	f	g	h	i	k	l	m	n	o	α
330-2	2	7	46	26	5.5	24	10	20	66	12	8	44	31	5.5	5	115°
330-3	3	9	62	28	6.5	29	15	22	75	16	9	46	36	7	6	90°
330-4	4	13.5	112	39	8.5	61	10	22	120	20	8	64	62	9	8	125°

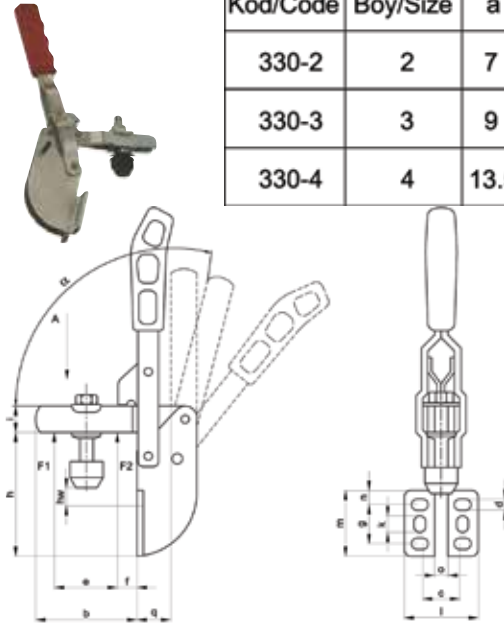

Kod Code	Boy Size	F1 (N)	F2 (N)	Diagram		hw	Diagram	g
330-2	2	1000	1200	185	75	14 / 22	M5 x 35	217
330-3	3	1800	2500	225	110	11 / 21	M8 x 45	465.5
330-4	4	2000	3000	300	180	15 / 40	M8 x 70	1200

330 Yan Tabanlı Dikey Sıkma Takımları

330 - 2	(Czmk 803-2)	(Kukomed 213-2)	23560	461.00 TL
330 - 3	(Czmk 803-2)	(Kukomed 213-3)	23561	548.00 TL
330 - 4	(Czmk 803-3)	(Kukomed 213-4)	23562	722.00 TL

Kod/Code	Boy/Size	a	b	c	d	e	f	g	h	i	k	l	m	n	o	p	α
320-2	2	7	50	20	5.5	24	10	32	40	12	5.5	12	35	33.5	5	2.75	115°
320-3	3	9	75	24	5.5	24	27	38	48	16	6	15	43	40.5	6	1.5	90°
320-4	4	13	125	40	8.5	24	30	-	70	20	9	22	4	63	8	8	125°
321-4	4	8	127	40	8.5	24	30	-	75	20	9	22	4	63	8	8	125°

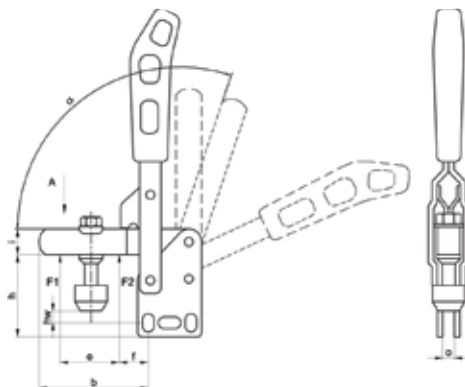

Kod Code	Boy Size	F1 (N)	F2 (N)	Diagram		hw	Diagram	g
320-2	2	800	1200	155	75	14 / 21	M5 x 35	177
320-3	3	1800	2500	200	110	8 / 18	M8 x 45	380
320-4	4	2000	3000	260	182	15 / 35	M8 x 70	900
321-4	4	2000	3000	260	182	-	-	880

320 Dik Tabanlı Dikey Sıkma Takımları

320 - 2	(Czmk 802-2)	(Kukomed 212-2)	23535	375.00 TL
320 - 3	(Czmk 802-2)	(Kukomed 212-3)	23537	481.00 TL
320 - 4	(Czmk 802-3)	(Kukomed 212-4)	23539	597.00 TL



Kod/Code	Boy/Size	a	b	c	d	e	f	g	h	k	l	m	n	o	p
510-1	1	8	50	25	4.3	35	17	25	18	M12 x 1.5	16	34	43	9	50
510-2	2	10	55	32	6.5	35	17	27	22	M16 x 1.5	16	35	50	7.5	60
510-3	3	13	72	40	6.7	40	30	30	22	M20 x 1.5	20	43	60	13	78

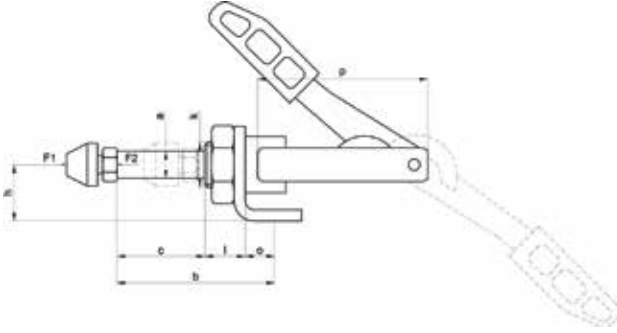

Kod Code	Boy Size	F1 (N)	F2 (N)														
510-1	1	1500	1500	60	150	M5 x 30	142										
510-2	2	2500	2500	75	215	M6 x 35	243.5										
510-3	3	4000	4000	105	270	M8 x 50	527.5										

510 Sac Gövde İtme Çekme Takımları

510 - 1	(Czmk 841-1)	(Kukomed 511-1)	23581	511.00 TL
510 - 2		(Kukomed 511-2)	23582	578.00 TL
510 - 3	(Czmk 841-3)	(Kukomed 511-3)	23583	713.00 TL



Kod/Code	Boy/Size	a	b	c	d	e	f	g	h	k	l	m	n	o	p	r
511-3	3	15	83	45	6.7	40	30	30	26	M20 x 1.5	20	43	60	15	18	78

Kod Code	Boy Size	F2 (N)					
511-3	3	80 - 100	105	270	550		

511 Yaylı İtme Çekme Tip Destekleme ve Sıkma Takımı

511 - 3	(Kukomed 511-3)	23572	825.00 TL
---------	-----------------	-------	-----------

Kod/Code	Boy / Size	a	b	c	d	e	f	g	h	l	m	n	o	p	t
610-4	4	8	125	32	8.5	19	6	43	25	50	50	60	25	90	60

Kod Code	Boy Size	F1 (N)			Ayar aralığı	
610-4	4	4500	140	92	60	785

610 Kancalı Sıkma Takımı

610 -2

610 -3

610 -4 (Czmk 848-4) (Kukomed 311-4) 23577 625.00 TL

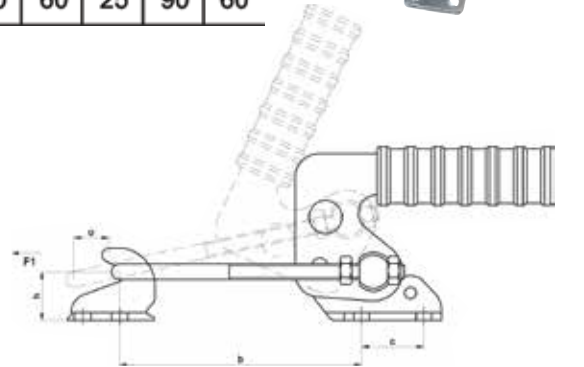
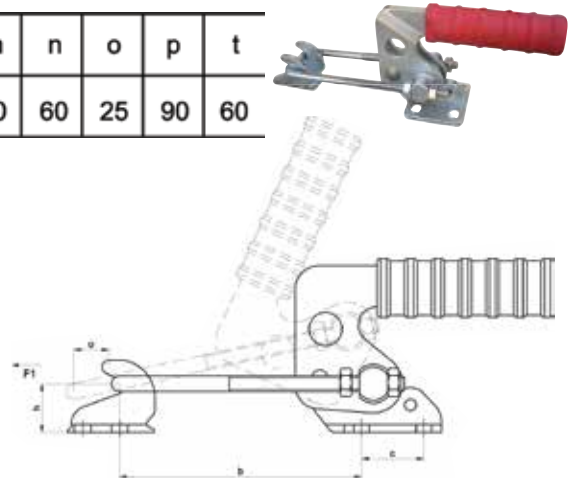

Kod / Code	Boy / Size	a	b	c	d	e	f	g	h	k	l	m	n	o	p	r	s	t	v
640-2	2	Ø6.9	19	39.5	6.5	16	82	16	32	3	44	4.4	6.9	18.1	25.5	6.4	14.2	28	38

Kod Code	Boy Size	F1 (N)			Ayar aralığı	
640-2	2	3200	173	66	0-20	300

641 Kancalı Destek ve Sıkma Takımı

641 - 2 23575 319.00 TL

641 - 3 377.00 TL

640 Kancalı Destek ve Sıkma Takımı

640 - 2 319.00 TL



Kod/Code	Boy/Size	a	b	c	d	d1	e	f	g	h	i	k	l	m	n	p	q	r	α
410-1	1	5.5	40	23.5	5.3	-	24	10	5	22	11	6.5	11.5	20	13	3	8.2	-	85°
410-2	2	7	53	26	5.5	-	26	11	6	30	14	6	11.5	30	24	2.5	8.3	-	90°
410-3	3	9	82	26	6.5	5	45	23	7	42	15	8.5	-	28	23	2.5	8.8	13	90°
410-4	4	11	110	42	8.5	8.5	64	36	9	45	20	9	-	44	26	7.8	16	19.7	90°
410-5	5	8	120	52	8.5	8.5	72	38	7.5	53	26	10.7	-	45	42	1.5	10	26	90°

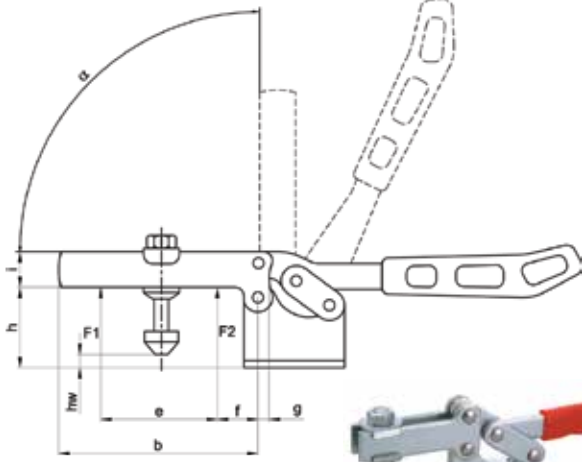

Kod Code	Boy Size	F1 (N)	F2 (N)	hw	g
410-1	1	800	1000	30	115
410-2	2	1000	1200	44	156
410-3	3	1750	2450	56	210
410-4	4	2000	3000	74	280
410-5	5	2250	3250	78	310

410-4 XY - 2000 - 3000 - 140 - 310 M12x90 805

410 Düz Tabanlı Yatay İtme Çekme Takımları

410 - 0																				299.00 TL
410 - 1	(Czmk 830-1)	(Kukomed 111-1)	23545	332.00 TL																
410 - 2	(Czmk 830-2)	(Kukomed 111-2)	23546	394.00 TL																
410 - 3	(Czmk 830-3)	(Kukomed 111-3)	23548	510.00 TL																
410 - 4	(Czmk 830-4)	(Kukomed 111-4)	23549	663.00 TL																
410 - 4XY				663.00 TL																
410 - 5	(Czmk 830-5)	(Kukomed 111-5)	23550	962.00 TL																

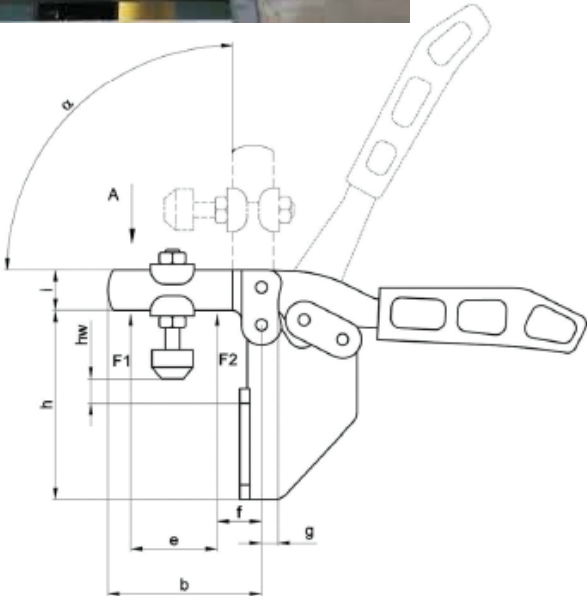
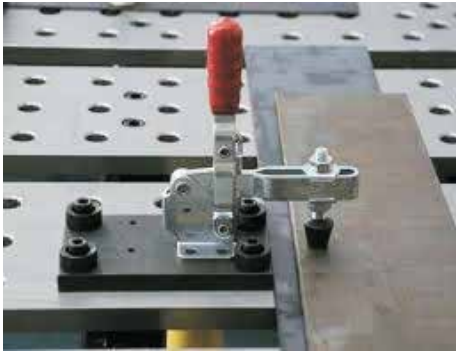

430 Yan Tabanlı Yatay Sıkma Takımları

430 - 2	(Kukomed 113-2)	529.00 TL
430 - 3	(Kukomed 113-3)	597.00 TL
430 - 4	(Kukomed 113-4)	750.00 TL

Kod Code	Boy Size	F1 (N)	F2 (N)	hw	g
430-2	2	1000	1200	156	79
430-3	3	1750	2450	210	91
430-4	4	2000	3000	280	132

Kod/Code	Boy/Size	a	b	c	d	d1	e	f	g	h	i	k	l	m	n	p	q	r	α
430-2	2	7	53	26	5.5	-	26	11	6	65	14	6	11.5	30	24	2.5	8.3	-	90°
430-3	3	9	82	26	6.5	5	45	23	7	76	15	8.5	-	28	23	2.5	8.8	13	90°
430-4	4	11	110	42	8.5	8.5	64	36	9	102	20	9	-	44	26	7.8	16	19.7	90°

Kod/Code	Boy/Size	a	b	c	d	d1	e	f	g	h	i	k	l	m	n	p	r	q	o	α
420-1	1	5.5	40	23.5	5.3	-	24	10	5	35	11	6.5	-	32	27	3	-	8.2	5	85°
420-2	2	7	53	26	5.5	-	26	11	6	45	14	6	11.5	39	36.5	2.5	-	8.3	5	90°
420-3	3	9	83	26	6.5	5	45	23	4	58	15	8	-	49	46.5	2.5	13	9	6	90°
420-4	4	11	120	42	8.5	8.5	64	36	9	66	20	9	-	60	52	7.8	20	16	8	90°
420-5	5	8.5	130	52.5	8.5	8.5	65	33	9.5	78	26	10.7	-	60.5	68	1.5	26.2	10	8	90°

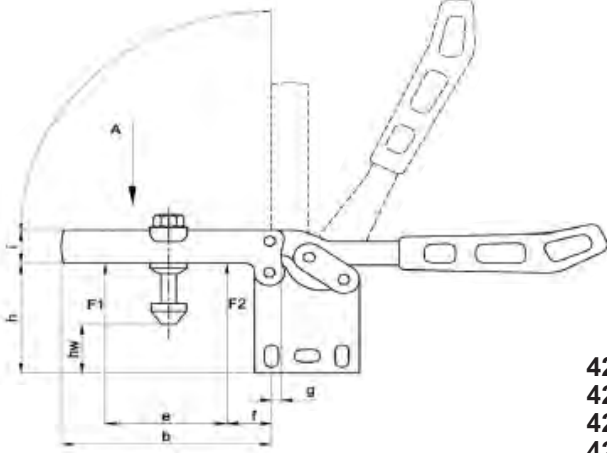

Kod Code	Boy Size	F1 (N)	F2 (N)			hw		
420-1	1	800	1000	46	130	10/20	M5 x 30	120
420-2	2	1000	1200	59	156	20/26	M6 x 40	175
420-3	3	1750	2450	72	210	20/30	M8 x 45	346
420-4	4	2000	3000	97	285	15/40	M8 x 70	805
420-5	5	2250	3250	104	300	28/43	M8 x 70	1020

420 Dik Tabanlı Yatay İtme Çekme Takımları

420 - 1	(Kukomed 112-1)	23601	260.00 TL
420 - 2	(Kukomed 112-2)	23602	305.00 TL
420 - 3	(Kukomed 112-3)	23603	392.00 TL
420 - 4	(Kukomed 112-4)	23604	510.00 TL



620 Yan Tabanlı Kancalı Sıkma Takımları

620 - 2	(Kukomed)
620 - 3	(Kukomed)
620 - 4	(Kukomed)

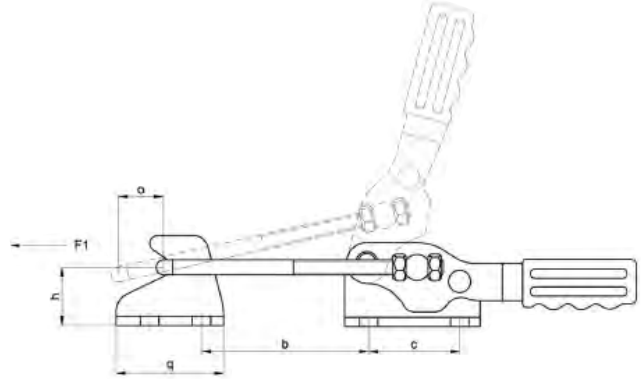

630 Yan Tabanlı Kancalı Sıkma Takımları

630 - 2	(Kukomed)
630 - 3	(Kukomed)
630 - 4	(Kukomed)

710 Paralel Tip Sıkma Takımları

710 - 2	(Kukomed)
---------	-----------

Bimetal Şerit Testereler

27x0.9 mm M42	9.50 € / mt
34x1.1 mm M42	12.00 € / mt
41x1.3 mm M42	16.50 € / mt
59x1.6 mm M42	26.00 € / mt
67x1.6 mm M42	38.00 € / mt
80x1.6 mm M42	44.00 € / mt
27x0.9 mm M42	11.50 € / mt
34x1.1 mm M42	14.00 € / mt
41x1.3 mm M42	19.00 € / mt
54x0.6 mm M42	30.00 € / mt
67x1.6 mm M42	40.00 € / mt
80x1.6 mm M42	49.00 € / mt



0100 - Çatal İki Ağız Anahtar

Kısa Boy

04 x 05 mm	61.25 TL
06 x 07 mm	63.00 TL
08 x 09 mm	64.50 TL
08 x 10 mm	71.00 TL
10 x 11 mm	70.25 TL
10 x 12 mm	70.25 TL
10 x 13 mm	75.25 TL
12 x 13 mm	77.25 TL
12 x 14 mm	77.25 TL
13 x 14 mm	77.25 TL
14 x 15 mm	89.00 TL
13 x 17 mm	101.25 TL
14 x 17 mm	104.00 TL
16 x 17 mm	104.00 TL
17 x 19 mm	111.75 TL
18 x 19 mm	111.75 TL
19 x 22 mm	125.50 TL
20 x 22 mm	130.00 TL
21 x 23 mm	136.25 TL
22 x 24 mm	142.25 TL
24 x 26 mm	146.50 TL
24 x 27 mm	146.50 TL
25 x 28 mm	181.50 TL
27 x 32 mm	216.50 TL
30 x 32 mm	216.50 TL



0130 - Çatal İki Ağız Anahtar

Uzun Boy

06 x 07 mm	79.75 TL
06 x 08 mm	82.75 TL
08 x 09 mm	82.75 TL
08 x 10 mm	82.75 TL
10 x 11 mm	91.25 TL
10 x 12 mm	91.25 TL
10 x 13 mm	91.25 TL
10 x 14 mm	91.25 TL
11 x 14 mm	91.25 TL
12 x 13 mm	96.00 TL
12 x 14 mm	96.00 TL
13 x 14 mm	96.00 TL
14 x 15 mm	111.75 TL
13 x 17 mm	122.00 TL
14 x 17 mm	122.00 TL
16 x 17 mm	123.25 TL
17 x 19 mm	131.50 TL
18 x 19 mm	131.50 TL
19 x 21 mm	153.00 TL
19 x 22 mm	153.00 TL
19 x 24 mm	153.75 TL
20 x 22 mm	153.00 TL
21 x 23 mm	156.50 TL
22 x 24 mm	166.00 TL
24 x 26 mm	189.50 TL
24 x 27 mm	189.50 TL
25 x 28 mm	212.00 TL
27 x 29 mm	264.50 TL
27 x 30 mm	264.50 TL
27 x 32 mm	264.50 TL
30 x 32 mm	264.50 TL
30 x 36 mm	501.50 TL
32 x 36 mm	501.50 TL
36 x 41 mm	778.75 TL
41 x 46 mm	1200.75 TL
46 x 50 mm	1331.50 TL



0100 - Çatal İki Ağız Anahtar Takımı

Kısa Boy

8'li (06-22 mm)	709.75 TL
12'li (06-32 mm)	1390.50 TL

0130 - Çatal İki Ağız Anahtar Takımı

Uzun Boy

8'li (06-22 mm)	869.25 TL
12'li (06-32 mm)	1691.75 TL



0320 - Kombine Anahtar Takımı

Kısa Boy

8'li (6-19 mm)	952.25 TL
12'li (8-22 mm)	1701.75 TL
17'li (6-22 mm)	2474.75 TL
21'li (6-32 mm)	4035.75 TL

0330 - Kombine Anahtar Takımı

Uzun Boy

8'li (6-19 mm)	1059.75 TL
12'li (8-22 mm)	1885.75 TL
17'li (6-22 mm)	2373.50 TL
21'li (6-32 mm)	4465.50 TL



0340 - Cırcır Kombine Anahtar

8 mm	398.75 TL
9 mm	397.75 TL
10 mm	417.00 TL
11 mm	419.25 TL
12 mm	454.75 TL
13 mm	486.75 TL
14 mm	501.50 TL
15 mm	531.50 TL
16 mm	609.00 TL
17 mm	644.75 TL
18 mm	699.00 TL
19 mm	742.00 TL
21 mm	1032.50 TL
22 mm	1132.25 TL
24 mm	1279.00 TL



0345 - Mafsallı Cırcır Kombine Anahtar

10 mm	699.75 TL
13 mm	795.25 TL
17 mm	967.25 TL
19 mm	1088.25 TL



0335 - Çoklu Yıldız Cırcır Anahtar

10x13x17x19 mm	1476.25 TL
----------------	------------



0330 - Kombine Anahtar

Uzun Boy

5 mm	92.25 TL
6 mm	92.25 TL
7 mm	92.25 TL
8 mm	107.50 TL
9 mm	109.25 TL
10 mm	120.75 TL
11 mm	127.75 TL
12 mm	127.75 TL
13 mm	143.00 TL
14 mm	148.50 TL
15 mm	159.00 TL
16 mm	160.25 TL
17 mm	181.50 TL
18 mm	196.00 TL
19 mm	213.25 TL
20 mm	226.25 TL
21 mm	241.00 TL
22 mm	287.25 TL
23 mm	350.00 TL
24 mm	350.00 TL
25 mm	350.00 TL
26 mm	412.25 TL
27 mm	412.25 TL
28 mm	412.25 TL
29 mm	412.25 TL
30 mm	473.50 TL
32 mm	496.25 TL
34 mm	506.00 TL
36 mm	573.25 TL
38 mm	586.75 TL
41 mm	667.75 TL
46 mm	906.75 TL
50 mm	1229.25 TL



0320 - Kombine Anahtar

Kısa Boy

6 mm	79.75 TL
7 mm	87.75 TL
8 mm	95.75 TL
9 mm	97.75 TL
10 mm	110.25 TL
11 mm	113.00 TL
12 mm	120.75 TL
13 mm	123.25 TL
14 mm	133.50 TL
15 mm	142.25 TL
16 mm	153.00 TL
17 mm	163.50 TL
18 mm	181.50 TL
19 mm	191.25 TL
20 mm	195.00 TL
21 mm	226.00 TL
22 mm	257.50 TL
23 mm	257.50 TL
24 mm	316.00 TL
25 mm	316.00 TL
26 mm	372.00 TL
27 mm	372.00 TL
28 mm	372.00 TL
29 mm	425.75 TL
30 mm	425.75 TL
32 mm	447.25 TL
34 mm	467.50 TL



0340 - Cırcırlı Kombine Anahtar Takımı

4'lü	2290.50 TL
10'lu	4994.00 TL

0430 - Yıldız İki Ağız Anahtar

06 x 07 mm	143.00 TL
08 x 09 mm	145.00 TL
08 x 10 mm	145.00 TL
10 x 11 mm	160.25 TL
10 x 12 mm	160.25 TL
11 x 13 mm	181.50 TL
12 x 13 mm	181.50 TL
12 x 14 mm	181.50 TL
14 x 15 mm	191.25 TL
13 x 17 mm	216.50 TL
14 x 17 mm	216.50 TL
16 x 17 mm	216.50 TL
17 x 19 mm	257.25 TL
18 x 19 mm	257.25 TL
20 x 22 mm	282.00 TL
21 x 23 mm	323.25 TL
22 x 24 mm	323.25 TL
24 x 26 mm	376.75 TL
24 x 27 mm	376.75 TL
25 x 28 mm	412.25 TL
27 x 29 mm	453.50 TL
27 x 32 mm	453.50 TL
30 x 32 mm	453.50 TL
30 x 36 mm	699.00 TL
32 x 36 mm	699.00 TL
36 x 41 mm	949.50 TL
41 x 46 mm	1300.75 TL
46 x 50 mm	2069.50 TL

0440 - Düz Yıldız Anahtar

06 x 07 mm	131.50 TL
08 x 09 mm	137.50 TL
10 x 11 mm	152.25 TL
12 x 13 mm	164.25 TL
14 x 15 mm	191.25 TL
16 x 17 mm	226.25 TL
18 x 19 mm	236.75 TL
20 x 22 mm	275.00 TL
21 x 23 mm	325.75 TL
24 x 26 mm	330.00 TL
25 x 28 mm	384.75 TL
27 x 32 mm	475.50 TL

0440 - Düz Yıldız Anahtar Takımı

12'li (06-32 mm) 3030.75 TL

0430 - Yıldız İki Ağız Anahtar Takımı

8'li (06-22 mm) 1576.75 TL
12'li (06-32 mm) 3142.50 TL

0600 - Kurbağacık Anahtar

6"	458.75 TL
8"	573.75 TL
10"	739.25 TL
12"	1021.50 TL
15"	1600.25 TL

0700 - Çatal Çakma Anahtar

24 mm	340.75 TL
27 mm	422.75 TL
30 mm	519.00 TL
32 mm	582.50 TL
36 mm	654.00 TL
38 mm	787.50 TL
41 mm	855.00 TL
42 mm	988.00 TL
46 mm	1087.50 TL
47 mm	1270.00 TL
50 mm	1358.50 TL
55 mm	1820.75 TL
60 mm	1976.75 TL
65 mm	2843.25 TL
70 mm	3639.25 TL
75 mm	3856.00 TL
80 mm	4903.25 TL
75 mm	3856.00 TL
90 mm	6687.75 TL
95 mm	7132.25 TL
100 mm	10108.25 TL

0750 - Yıldız Çakma Anahtar (Darbeli)

24 mm	477.25 TL
27 mm	569.75 TL
30 mm	679.50 TL
32 mm	781.00 TL
36 mm	883.75 TL
38 mm	1058.25 TL
41 mm	1155.25 TL
42 mm	1320.75 TL
46 mm	1381.00 TL
47 mm	1524.00 TL
50 mm	1630.50 TL
55 mm	2293.50 TL
60 mm	2488.50 TL
65 mm	3253.00 TL
70 mm	3724.25 TL
75 mm	3986.25 TL
80 mm	5661.50 TL
75 mm	3986.25 TL
90 mm	7835.25 TL
95 mm	8835.00 TL
100 mm	10213.50 TL

1107 - Altıköşe Lokma Anahtar 1/4"

4 mm	26.25 TL
5 mm	26.25 TL
6 mm	26.25 TL
7 mm	26.25 TL
8 mm	26.25 TL
9 mm	28.50 TL
10 mm	28.50 TL
11 mm	36.00 TL
12 mm	36.00 TL
13 mm	41.25 TL

1107 - Altıköşe Derin Lokma Anahtar 1/4"

4 mm	50.50 TL
5 mm	50.50 TL
6 mm	57.00 TL
7 mm	57.00 TL
8 mm	57.00 TL
10 mm	61.00 TL
11 mm	65.50 TL
12 mm	65.50 TL
13 mm	65.50 TL

1107 - Lokma Star Torx Uç 1/4"

T 30	46.00 TL
T 40	46.00 TL

1507 - Ara Kol 1/4"

100 mm	71.75 TL
--------	----------

1507 - T Kol 1/4"

100 mm	119.00 TL
--------	-----------

1507 - Cırcır Kol 1/4"

140 mm	472.75 TL
--------	-----------

1107 - Lokma Takımı 1/4"

15 Parça 1153.- TL

Altı köşeli : 4 - 5 - 6 - 7 - 8 - 9 -
10 - 11 - 12 - 13

Sekiz köşeli yıldız : 8 - 10

1113 - Altıköşe Lokma Anahtar 1/2"

8 mm	86.25 TL
9 mm	86.25 TL
10 mm	107.25 TL
11 mm	107.25 TL
12 mm	107.25 TL
13 mm	115.25 TL
14 mm	115.25 TL
15 mm	115.25 TL
16 mm	120.75 TL
17 mm	120.75 TL
18 mm	120.75 TL
19 mm	126.00 TL
20 mm	126.00 TL
21 mm	126.00 TL
22 mm	126.00 TL
23 mm	131.25 TL
24 mm	131.25 TL
26 mm	131.25 TL
27 mm	150.25 TL
28 mm	150.25 TL
30 mm	158.25 TL
32 mm	164.75 TL

1113 - Lokmalı Allen Uçlar 1/2"

5 mm - 100 mm	162.50 TL
6 mm - 100 mm	162.50 TL
7 mm - 100 mm	162.50 TL
8 mm - 100 mm	162.50 TL
10 mm - 100 mm	187.75 TL
12 mm - 100 mm	187.75 TL
14 mm - 100 mm	226.00 TL

1513 - Mafsal 1/2"

70 mm 286.50 TL

1113 - Lokmalı Star Torx Uçlar 1/2"

T 20 - 60 mm	169.25 TL
T 25 - 60 mm	169.25 TL
T 30 - 60 mm	169.25 TL
T 40 - 60 mm	169.25 TL
T 45 - 60 mm	169.25 TL
T 50 - 60 mm	169.25 TL
T 55 - 60 mm	169.25 TL
T 60 - 60 mm	169.25 TL

1513 - Lokma Adaptörleri 1/2"

1/2" Fx3/8" M 105.75 TL
1/2" Fx3/4" M 166.00 TL

1113 - Buji Lokma Anahtar 1/2" (Lastikli)

16 mm	154.75 TL
21 mm	199.50 TL

1113 - Lokmalı Star Torx Uçlar Uzun 1/2"

T 40 - 100 mm	191.50 TL
T 45 - 100 mm	191.50 TL

1113 - Altıköşe Lokma Anahtar Takımı 1/2"

24 Parça 4581.75 TL
10 - 11 - 12 - 13 - 14 - 15 - 16 -
17 - 18 - 19 - 21 - 22 - 23 - 24 -
26 - 27 - 28 - 30 - 32

1114 - Oniki köşe Lokma Anahtar 1/2"

13 mm	116.25 TL
19 mm	127.00 TL

1114 - 12 Köşe Lokmalı Bits Uçlar 1/2" Yivli (XZN)

M8 - 60 mm	124.50 TL
M10 - 60 mm	124.50 TL
M12 - 60 mm	147.75 TL

1108 - Altıköşe Derin Lokma Anahtar 1/2"

10 mm	200.75 TL
11 mm	200.75 TL
12 mm	200.75 TL
13 mm	215.00 TL
14 mm	215.00 TL
15 mm	215.00 TL
16 mm	235.50 TL
17 mm	235.50 TL
18 mm	235.50 TL
19 mm	235.50 TL

1513 - Cırcır Kol 1/2"

250 mm 891.00 TL

1113 - Altıköşe Lokma Anahtar Takımı 1/2"

17 Parça 3375.50 TL
10 - 11 - 12 - 13 - 14 - 15 - 17 -
19 - 22 - 24 - 26 - 27 - 30

1113 - Lokmalı Allen Uçlar 1/2"

5 mm - 60 mm	137.50 TL
6 mm - 60 mm	137.50 TL
7 mm - 60 mm	137.50 TL
8 mm - 60 mm	137.50 TL
10 mm - 60 mm	156.75 TL
12 mm - 60 mm	156.75 TL
14 mm - 60 mm	156.75 TL

1513 - T Kol 1/2"

250 mm 493.00 TL

1513 - Orta Ara Kol 1/2"

125 mm 226.00 TL

1513 - Ara Kol 1/2"

250 mm 343.00 TL

1113 - Altıköşe Lokma Anahtar Takımı 1/4"-1/2"

35 Parça 4811.50 TL
4 - 5 - 6 - 7 - 8 - 9 - 10 - 11 - 12 -
13 mm 1/4"
10 - 11 - 12 - 13 - 14 - 15 - 16 -
17 - 18 - 19 - 21 - 22 - 24 - 27 -
30 - 32 mm 1/2"

1119 - Altıköşe Lokma Anahtar 3/4"

22 mm	266.75 TL
24 mm	266.75 TL
27 mm	275.00 TL
30 mm	296.50 TL
32 mm	308.25 TL
34 mm	406.75 TL
36 mm	406.75 TL
38 mm	406.75 TL
41 mm	597.50 TL
46 mm	636.50 TL
50 mm	764.00 TL
55 mm	972.75 TL
60 mm	1161.50 TL

1119 - Altıköşe Lokma Anahtar Takımı 3/4"

14 Parça 10229.25 TL
22 - 24 - 27 - 30 - 34 - 32 - 36 -
41 - 46 - 50

1113 - Altıköşe Havalı Lokma Anahtar 1/2"

10 mm	122.50 TL
11 mm	122.50 TL
12 mm	122.50 TL
13 mm	131.25 TL
14 mm	131.25 TL
15 mm	151.00 TL
16 mm	158.00 TL
17 mm	158.25 TL
18 mm	159.00 TL
19 mm	161.75 TL
21 mm	170.50 TL
22 mm	195.00 TL
24 mm	201.75 TL
27 mm	256.25 TL

1800 - Kovan Anahtar İki Ağız

06 x 07 mm	124.25 TL
08 x 09 mm	136.00 TL
10 x 11 mm	186.00 TL
12 x 13 mm	197.50 TL
14 x 15 mm	216.50 TL
16 x 17 mm	232.25 TL
18 x 19 mm	241.00 TL
20 x 22 mm	265.25 TL
21 x 23 mm	196.55 TL
22 x 24 mm	298.00 TL
24 x 27 mm	384.75 TL
25 x 28 mm	299.80 TL

1800 - Kovan Anahtar Takımı İki Ağız (2 Adet Mil Dahil)

8'li (6-22 mm) 1722.50 TL



1519 - Cırcır Kol 3/4"
510 mm 2641.75 TL



1519 - Ara Kol 3/4"
200 mm 696.75 TL



1519 - Ara Kol 3/4"
400 mm 1262.00 TL



1519 - T Kol 3/4"
500 mm 1404.00 TL



1519 - Lokma Adaptörleri 3/4"
3/4" Fx1/2" M 278.00 TL
3/4" Fx1" M 376.00 TL



1525 - Lokma Adaptörleri 1"
1" Fx3/4" M 536.50 TL

1108 - Altıköşe Havalı Derin Lokma Anahtar 1/2"

10 mm	122.50 TL
11 mm	122.50 TL
12 mm	122.50 TL
13 mm	131.25 TL
14 mm	131.25 TL
15 mm	151.00 TL
17 mm	158.25 TL
19 mm	161.25 TL
21 mm	170.50 TL
22 mm	195.00 TL
24 mm	201.75 TL
27 mm	256.25 TL
30 mm	300.00 TL
32 mm	327.00 TL



1519 - Havalı Lokma Adaptörleri 3/4"
3/4" Fx1/2" M 584.50 TL

1940 - Ağır Tip Bijon Anahtarı Uzun İki Ağız

24x27	526.00 TL
27x30	604.00 TL
27x32	604.00 TL
30x32	625.00 TL
32x33	693.50 TL

1940 - Pipo Tipi Bijon Anahtar

17 mm	326.79 TL
19 mm	345.25 TL
21 mm	373.00 TL

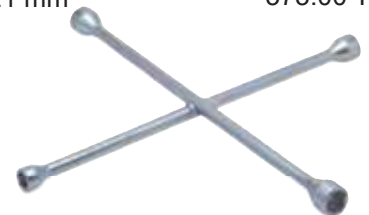
1975 - İstavroz Tipi Bijon Anahtar

17x19 mm	650.25 TL
21(13/16)x22 mm	





6205 - Alüminyum ve Saç Kesme Makası Sağ 686.50 TL
240 mm



6206 - Alüminyum ve Saç Kesme Makası Sol 686.50 TL
240 mm



6207 - Alüminyum ve Saç Kesme Makası Düz 686.50 TL
240 mm

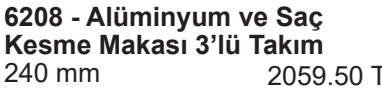

6208 - Alüminyum ve Saç Kesme Makası 3'lü Takım 2059.50 TL
240 mm



2100 - Stilson Boru Anahtarı
8" (210) 824.00 TL
10" (265) 991.25 TL
12" (318) 1115.25 TL
14" (373) 1369.00 TL
18" (477) 1737.75 TL
24" (615) 2799.00 TL



2201 - Maşalı Boru Anahtarı 85°
1" (40) 839.00 TL
1 1/2" (60) 1299.50 TL
2" (70) 1945.50 TL
3" (100) 2949.00 TL
4" (130) 4422.50 TL



2110 - Ağır Tip Boru Anahtarı
8" (200) 1094.50 TL
10" (250) 1358.25 TL
12" (300) 1555.50 TL
14" (350) 1811.00 TL
18" (450) 2526.75 TL
24" (600) 4047.75 TL
36" (900) 9023.00 TL
48" (1200) 18479.75 TL



2400 - Ünlversal Fort Pense (PVC) DIN 8976
240 mm 718.75 TL
315 mm 1177.00 TL



6820 - Tenekeci Makası
200 mm 580.00 TL
250 mm 741.25 TL
300 mm 807.75 TL

6821 - Tenekeci Makası (Yaylı)
250 mm 805.00 TL
300 mm 880.25 TL



6710 - Bağ Makası (Lüks)
230 mm 619.00 TL



6715 - Bağ Makası (Confort)
225 mm 941.75 TL



6720 - Bağ Makası (Hafif Tip)
220 mm 1092.75 TL



6210 - Kaportacı Makası (Sağ)
250 mm 863.00 TL
275 mm 944.00 TL
300 mm 1076.00 TL



6211 - Kaportacı Makası (Sol)
250 mm 863.00 TL
275 mm 944.00 TL
300 mm 1076.00 TL



6800 - Kuyumcu Makası Düz
180 mm 700.25 TL



680 1- Kuyumcu Makası Eğri
180 mm 766.00 TL



2415 - Yaylı Fort Pense
240 mm 969.25 TL



2500 - Ünlversal Ayarlı Pense
250 mm 856.00 TL



2505 - Standart Ayarlı Pense
250 mm 856.00 TL



2510 - Special Ayarlı Pense
250 mm 856.00 TL



2512 - Kaynakçı Ayarlı Pense (Düz Ağız)
200 mm 1444.00 TL



2513 - Kaynakçı Ayarlı Pense (Boru için)
280 mm 1444.00 TL



2515 - Kaportacı Ayarlı Pense
270 mm 1146.25 TL



6855 - Standart Boru Kesici Bakır ve Alüminyum için
1/8" - 1 1/8" 706.00 TL



03752 - Kablo Sıyırıcı
Tek 6/300, Çok 1.5/25 504.25 TL



3020 - Kombine Pense
160 Opak Seri 447.00 TL
180 Opak Seri 507.25 TL
200 Opak Seri 572.00 TL



3225 - Kargaburun Eğri Uçlu
160 Opak Seri 525.50 TL
180 Opak Seri 594.00 TL
200 Opak Seri 634.25 TL



3550 - Yan Keski Elektronikçi Tip
125 mm 637.50 TL



3020 - Kombine Pense
160 Kraft Seri 547.50 TL
180 Kraft Seri 611.50 TL
200 Kraft Seri 572.00 TL



3225 - Kargaburun Eğri Uçlu
160 Kraft Seri 632.00 TL
180 Kraft Seri 694.00 TL
200 Kraft Seri 763.25 TL



3553 - Düz Uçlu Kargaburun Elektronikçi Tip
150 mm 575.25 TL



3020 - 1000V İzoleli Elektrikçi Kombine Pense
160 TUV GS 614.75 TL
180 TUV GS 658.75 TL
200 TUV GS 743.00 TL



3700 - Yan Keski
140 Opak Seri 465.00 TL
160 Opak Seri 560.00 TL
180 Opak Seri 652.75 TL



3554 - Uzun Kargaburun Elektronikçi Tip
150 mm 575.25 TL



3220 - Uzun Kargaburun Düz Uçlu
140 Opak Seri 440.00 TL
160 Opak Seri 497.75 TL
180 Opak Seri 546.75 TL
200 Opak Seri 579.75 TL



3700 - Yan Keski
140 Kraft Seri 561.00 TL
160 Kraft Seri 673.50 TL
180 Kraft Seri 784.50 TL



3555 - Sivri Uçlu Düz Kargaburun Elektronikçi Tip
150 mm 575.25 TL



3220 - Uzun Kargaburun Düz Uçlu
140 Kraft Seri 440.00 TL
160 Kraft Seri 497.75 TL
180 Kraft Seri 546.75 TL
200 Kraft Seri 579.75 TL



3700 - 1000V İzoleli Elektrikli Yan Keski
140 TUV GS 705.50 TL
160 TUV GS 800.75 TL
180 TUV GS 895.75 TL



3556 - Sivri Uçlu Eğri Kargaburun Elektronikçi Tip
150 mm 575.25 TL



3220 - 1000V İzoleli Elektrikli Kargaburun Düz Uçlu
140 TUV GS 629.50 TL
160 TUV GS 695.75 TL
180 TUV GS 781.00 TL
200 TUV GS 811.25 TL



3730 - Yan Keski Ağır Tip
160 mm 793.75 TL
200 mm 1031.50 TL



3557 - Elektronikçi Pense
125 mm 575.25 TL



3860 - Testere Çaprazı
180 mm 742.00 TL



3420 - Hortum Kelepçe Pensesi
220 mm 933.50 TL



3830 - Betoncu Kerpeteni
280 mm 752.75 TL



3800 - Kerpeten
160 mm 459.75 TL
180 mm 475.75 TL



3301 - Dış Segman Pens (Yaylı Düz)

140 mm	525.00 TL
180 mm	554.00 TL
225 mm	692.00 TL
295 mm	1173.00 TL



3311 - Dış Segman Pens (Yaylı Eğri)

125 mm	587.00 TL
170 mm	618.00 TL
210 mm	710.50 TL
275 mm	1231.75 TL



3321 - İç Segman Pens (Yaysız Düz)

140 mm	483.75 TL
180 mm	510.25 TL
225 mm	635.00 TL
310 mm	1089.50 TL



3331 - İç Segman Pens (Yaysız Eğri)

130 mm	520.00 TL
170 mm	547.50 TL
210 mm	683.00 TL
290 mm	1172.00 TL



4550 - Kontrol Kalemi

135 mm	93.50 TL
190 mm	119.75 TL



4100 - Kraft Seri Düz Uçlu Tornavida

3 x 40 mm	78.75 TL
3 x 80 mm	83.75 TL
4 x 80 mm	90.25 TL
4 x 100 mm	104.75 TL
5 x 80 mm	110.75 TL
5 x 100 mm	121.50 TL
5 x 125 mm	138.75 TL
5 x 150 mm	152.00 TL
6 x 100 mm	124.50 TL
6 x 125 mm	143.00 TL
6 x 150 mm	156.75 TL
6 x 175 mm	201.00 TL
7 x 125 mm	159.00 TL
7 x 150 mm	183.50 TL
7 x 175 mm	210.25 TL
8 x 150 mm	208.75 TL
8 x 175 mm	222.50 TL
8 x 200 mm	272.25 TL
9 x 200 mm	290.00 TL
11 x 250 mm	368.50 TL



4120 - Kraft Seri Yıldız Uçlu Tornavida

3 x 60 mm - PH0	88.75 TL
4.5 x 80 mm - PH1	127.75 TL
4.5 x 100 mm - PH1	142.00 TL
4.5 x 150 mm - PH1	169.75 TL
6 x 100 mm - PH2	153.25 TL
6 x 150 mm - PH2	185.50 TL
6 x 200 mm - PH2	238.25 TL
8 x 150 mm - PH3	290.75 TL
10 x 200 mm - PH4	449.00 TL



4100 - Kraft Seri Tornavida Seti 7 Parça

855.25 TL



4100 - Kraft Seri Düz Uç Tornavida Seti 8 Parça

963.25 TL



4120 - Kraft Seri Yıldız Uç Tornavida Seti 6 Parça

865.00 TL



4120 - Kraft Seri Süngüsü Uzun Yıldız Uç Tornavida

4.5 x 300 mm PH1	400.75 TL
6 x 300 mm PH2	414.25 TL



4100 - Kraft Seri Süngüsü Uzun Düz Uç Tornavida

4 x 300 mm	256.50 TL
5 x 250 mm	287.25 TL
5 x 350 mm	323.75 TL
6 x 350 mm	342.75 TL



4130 - Kraft Yıldız Uç Topaç Tornavida

4.5 x 40 mm	122.00 TL
4.5 x 25 mm	96.75 TL
6 x 25 mm	101.50 TL
6 x 40 mm	137.50 TL



4110 - Kraft Düz Uç Topaç Tornavida

5.5 x 25 mm	90.75 TL
5.5 x 40 mm	122.50 TL
6.5 x 25 mm	101.25 TL
6.5 x 40 mm	138.75 TL



4775 - Torx Uçlu Tornavida

T 10	115.25 TL
T 15	115.25 TL
T 20	127.75 TL
T 25	147.75 TL
T 27	162.75 TL
T 30	172.75 TL
T 40	215.00 TL
T 45	242.75 TL



4775 - Torx Uçlu Tornavida Seti 7 Parça

1056.50 TL



4770 - Lokma Uçlu Tornavida

4 mm	231.25 TL
5 mm	231.25 TL
5.5 mm	231.25 TL
6 mm	231.25 TL
7 mm	248.50 TL
8 mm	248.50 TL
9 mm	268.00 TL
10 mm	268.00 TL
11 mm	293.00 TL
12 mm	314.00 TL
13 mm	338.25 TL
14 mm	374.00 TL

4500 - Elektronikçi Tip (Klemens) Düz Uçlu Tornavida

2.5 x 60 mm	71.25 TL
2.5 x 80 mm	74.75 TL
3 x 80 mm	79.25 TL
3 x 100 mm	96.75 TL
3 x 125 mm	127.75 TL
3.5 x 100 mm	99.50 TL
4 x 80 mm	81.50 TL
4 x 100 mm	99.50 TL
4 x 125 mm	134.00 TL
4 x 150 mm	145.75 TL

4520 - Elektronikçi Tip (Klemens) Yıldız Uçlu Tornavida

3 x 60 mm	85.75 TL
4 x 80 mm	120.00 TL
4 x 150 mm	160.00 TL

4500 - Elektronikçi Tip (Klemens) Tornavida Seti

6 Parça 653.25 TL

4540 - Klips Sökme Tornavida

290 mm 376.50 TL

4140 - 1000V Elektronikçi Tip Düz Uçlu Tornavida

2.5 x 75 mm	101.25 TL
4 x 100 mm	118.50 TL
5 x 125 mm	136.50 TL
6 x 150 mm	174.50 TL

4145 - 1000V Elektronikçi Tip Yıldız Uçlu Tornavida

3 x 60 mm	105.00 TL
4.5 x 80 mm	148.50 TL
6 x 100 mm	174.50 TL

4140 - 1000V İzoleli Elektronikçi Tip Tornavida Seti

6 Parça 873.75 TL

4900 - Allen Anahtar Altı köşe

1.5 mm	10.25 TL
2 mm	14.75 TL
2.5 mm	18.25 TL
3 mm	19.50 TL
3.5 mm	24.75 TL
4 mm	25.25 TL
5 mm	29.00 TL
6 mm	38.00 TL
7 mm	56.00 TL
8 mm	64.50 TL
9 mm	79.25 TL
10 mm	97.75 TL
12 mm	141.50 TL
14 mm	226.00 TL
16 mm	416.00 TL
17 mm	449.00 TL
19 mm	554.75 TL
22 mm	926.75 TL
24 mm	1250.00 TL

4903 - Altıköşe Allen Anahtarı Uzun Boy

2 mm	21.25 TL
2.5 mm	24.75 TL
3 mm	28.25 TL
4 mm	35.50 TL
5 mm	39.50 TL
6 mm	64.50 TL
7 mm	95.25 TL
8 mm	103.75 TL
10 mm	174.00 TL
12 mm	249.75 TL

4910 - Torx Allen Anahtarı

T25 106.75 TL

4903 - Allen Anahtar Takımı Uzun Boy

10'lu (2-10 mm)	727.25 TL
12'li (2-12 mm)	1011.50 TL

4900 - Allen Anahtar Takımı Kısa Boy

10'lu (2-10 mm)	442.25 TL
12'li (2-12 mm)	608.50 TL

4920 - T Tipi Allen Anahtar Takım 8 Parça

1560.25 TL

4906 - Yuvarlak Başlı Allen Anahtarı Uzun Boy

1.5 mm	31.75 TL
2 mm	42.25 TL
2.5 mm	45.75 TL
3 mm	49.00 TL
4 mm	56.00 TL
5 mm	70.25 TL
6 mm	80.75 TL
8 mm	128.00 TL
10 mm	190.25 TL

4905 - Yuvarlak Başlı Allen Anahtarı Kısa Boy

8 mm 104.00 TL

4906 - Yuvarlak Başlı Allen Anahtar Takım Uzun Boy

9 Parça 694.00 TL

4905 - Yuvarlak Başlı Allen Anahtar Takım Kısa Boy

8 Parça 504.25 TL

4909 - T Tip Torx Allen Anahtar

T9	249.75 TL
T10	254.75 TL
T15	260.00 TL
T20	262.25 TL
T25	268.00 TL
T30	306.25 TL
T40	317.75 TL

4921 - T Allen Anahtar Yuvarlak Başlı

2.5 mm	175.25 TL
3 mm	177.75 TL
4 mm	199.00 TL
5 mm	213.50 TL
6 mm	244.50 TL
7 mm	256.00 TL
8 mm	275.00 TL
10 mm	456.00 TL

4921 - T Tipi Yuvarlak Başlı Allen Anahtar Takım 8 Parça

1997.- TL

4920 - T Allen Anahtar

2.5 mm	135.00 TL
3 mm	137.50 TL
4 mm	154.00 TL
5 mm	164.75 TL
6 mm	188.00 TL
7 mm	197.50 TL
8 mm	232.00 TL
10 mm	331.00 TL

4910 - Torx Allen Anahtar Takım 8 Parça

854.75 TL



4820 - Yıldız Bits Uç

PH1 x 25 mm	18.50 TL
PH2 x 25 mm	18.50 TL
PH3 x 25 mm	18.50 TL
PH1 x 50 mm	33.25 TL
PH2 x 50 mm	33.25 TL
PH3 x 50 mm	33.25 TL



4870 - Yıldız Bits Uç

PH1 x 75 mm	64.50 TL
PH2 x 75 mm	64.50 TL
PH3 x 75 mm	64.50 TL
PH1 x 100 mm	68.25 TL
PH2 x 100 mm	68.25 TL
PH3 x 100 mm	68.25 TL
PH1 x 150 mm	96.00 TL
PH2 x 150 mm	96.00 TL
PH3 x 150 mm	96.00 TL



4830 - Torx Bits Uç

T25 x 25 mm	27.50 TL
T27 x 25 mm	27.50 TL
T30 x 25 mm	27.50 TL
T40 x 25 mm	27.50 TL
T25 x 50 mm	35.25 TL
T27 x 50 mm	35.25 TL
T30 x 50 mm	35.25 TL
T40 x 50 mm	35.25 TL



4885 - Torx Bits Uç

T25 x 75 mm	48.50 TL
T27 x 75 mm	48.50 TL
T30 x 75 mm	48.50 TL
T40 x 75 mm	48.50 TL
T25 x 100 mm	70.00 TL
T27 x 100 mm	70.00 TL
T30 x 100 mm	70.00 TL
T40 x 100 mm	70.00 TL
T25 x 150 mm	100.25 TL
T27 x 150 mm	100.25 TL
T30 x 150 mm	100.25 TL
T40 x 150 mm	100.25 TL



5010 - Iskerpela Düz

6 mm	249.25 TL
8 mm	266.25 TL
10 mm	281.00 TL
12 mm	308.25 TL
14 mm	318.75 TL
16 mm	341.00 TL
18 mm	369.75 TL
20 mm	411.25 TL
22 mm	445.50 TL
24 mm	481.50 TL
26 mm	498.75 TL
30 mm	532.50 TL



5500 - Düz Keski

100 mm	149.25 TL
125 mm	179.75 TL
150 mm	230.75 TL
175 mm	210.00 TL
200 mm	362.25 TL
250 mm	445.00 TL
300 mm	712.75 TL



5510 - Tesviyeci Düz Keski

125 mm	204.50 TL
150 mm	255.25 TL



5700 - Kayış Zımba

3 mm	127.75 TL
4 mm	133.50 TL
5 mm	145.00 TL
6 mm	147.75 TL
7 mm	162.75 TL
8 mm	172.75 TL
9 mm	192.75 TL
10 mm	205.50 TL
11 mm	220.75 TL
12 mm	264.25 TL
13 mm	278.00 TL
14 mm	305.50 TL
15 mm	350.00 TL
16 mm	383.50 TL
17 mm	419.00 TL
18 mm	457.00 TL
19 mm	496.75 TL
20 mm	529.00 TL



5540 - Nokta Zımba

4x120 mm Boyalı	172.75 TL
5x120 mm Boyalı	203.50 TL
5x150 mm Boyalı	225.25 TL
4x120 mm Krom	170.75 TL



5550 - Düz Pim Zımba

Ø 2 mm Boyalı	213.25 TL
Ø 3 mm Boyalı	213.25 TL
Ø 4 mm Boyalı	216.50 TL
Ø 5 mm Boyalı	216.50 TL
Ø 6 mm Boyalı	218.25 TL
Ø 7 mm Boyalı	227.50 TL
Ø 8 mm Boyalı	243.25 TL
Ø 9 mm Boyalı	246.75 TL
Ø 10 mm Boyalı	249.25 TL
Ø 5 mm Krom	190.25 TL



5500 - Düz Keski Kalkan İzoleli

250 mm	566.25 TL
300 mm	825.00 TL



5850 - Plastik Çekiç

30 mm	396.00 TL
40 mm	481.75 TL
50 mm	610.75 TL



5850 - Plastik Çekiç Yedeği

30 mm	89.75 TL
40 mm	127.75 TL
50 mm	182.50 TL



5800 - Tesviyeci Çekiç

100 gr	277.00 TL
200 gr	302.00 TL
300 gr	365.75 TL
500 gr	423.00 TL
1000 gr	611.50 TL
1500 gr	802.75 TL
2000 gr	987.00 TL



5870 - Lastik Çekiç

400 gr	766.75 TL
--------	-----------



6195 - Perçin Tabancası
260 mm 888.75 TL



6350 - Levye Oluklu
300 mm 267.00 TL
400 mm 336.75 TL
500 mm 467.75 TL
600 mm 571.50 TL



6360 - Levye Oluklu Kıvrık Uçlu
260 mm 631.50 TL



6370 - Yağ Filtre Sökeceği
75x100 mm 417.00 TL



6374 - Zincirli Filtre Sökeceği
60x140 mm 880.75 TL



6373 - Kayışlı Yağ Filtre Sökeceği
60x140 mm 1022.00 TL



6375 - Ayarlı Yağ Filtre Sökeceği
100 mm 488.25 TL



6390 - Segman Çemberi
125 mm 871.25 TL
175 mm 1662.50 TL



7010 - Standart Çektirme İki Kollu
8x10 mm 1736.50 TL
12x10 mm 1857.25 TL
16x15 mm 3165.25 TL
20x15 mm 3462.25 TL
25x20 mm 5980.00 TL
35x20 mm 7263.00 TL
52x20 mm 10675.75 TL



7030 - Master Çektirme İki Kollu
8x8 mm 699.75 TL
12x12 mm 1442.25 TL
16x16 mm 2170.25 TL
23x20 mm 2950.50 TL



7040 - Master Çektirme Üç Kollu
8x8 mm 1340.00 TL
12x12 mm 1960.75 TL
16x16 mm 2883.00 TL
23x20 mm 3881.75 TL



7050 - Batarya Çektirme İki Kollu
6x4 mm 778.50 TL
6x6 mm 802.75 TL
8x8 mm 843.25 TL



7060 - Batarya Çektirme Üç Kollu
6x4 mm 1010.75 TL
6x6 mm 1274.00 TL
8x8 mm 1477.00 TL



05886 - Arazi Tip Fiberglass Şerit Metre
20 m 539.75 TL
30 m 576.75 TL
50 m 926.75 TL



5880 - Su Terazisi
40 cm 806.25 TL
50 cm 873.50 TL
60 cm 949.75 TL
70 cm 1020.00 TL
80 cm 1102.00 TL
100 cm 1254.50 TL
120 cm 1484.00 TL



6220 - Spiralli Mıknatıs
500 mm 559.25 TL
1000 mm 592.50 TL



6230 - Gres Pompası
500 cc 886.25 TL



6760 - Plastik Boru Kesme Makası
42 mm 2365.25 TL
63 mm 4149.25 TL



4136 - Bez Sırt Çantası
70x28x48 mm 1859.25 TL



4137 - Bez Bel Çantası 635.00 TL



4133 - Bez Takım Çantası Büyük
250x350x480 mm 1697.75 TL



4135 - Bez Takım Çantası Orta
220x310x360 mm 1618.75 TL



4134 - Bez Takım Çantası Küçük
120x330x300 mm 1049.25 TL



Tekerlekçi Tamirci Kızağı Büyük 40"
14000004293 2015.75 TL

Tekerlekçi Tamirci Kızağı Küçük 36"
14000004293 1458.75 TL



8245 - Premium Seri Takım Dolabı 67 051.- TL
7 çekmeceli, 243 Parça
485x717x944 mm ebatlarında



8241 - Pro Seri Takım Dolabı 64 105.00 TL
8 çekmeceli, 206 Parça
485x717x944 mm ebatlarında



8235 - Partner Seri Takım Dolabı 36 471.50 TL
5 çekmeceli, 118 Parça
470x670x975 mm ebatlarında



8244 - Trend Takım Dolabı 12 707.50 TL
5 çekmeceli
410x618x894 mm ebatlarında

8244 - Trend Takım Dolabı Dolu 28 004.75 TL
5 çekmeceli, 93 parça
410x618x894 mm ebatlarında



8243 - Eko Seri Takım Dolabı 12 657.00 TL
5 çekmeceli,
410x620x894 mm ebatlarında

8243 - Eko Seri Takım Dolabı Dolu 27 954.25 TL
5 çekmeceli, 93 Parça
410x620x894 mm ebatlarında



5434 - Grand Master Seri Takım Dolabı 119.292.25 TL
251 parça



5434 - Klima Bakım Set 19 104.50 TL
78 parça



ELTA - 0150 Çatal İki Ağız Anahtar

Kısa Boy

06x07 mm	53.00 TL
08x09 mm	54.00 TL
10x11 mm	58.50 TL
12x13 mm	64.50 TL
14x15 mm	74.75 TL
16x17 mm	86.25 TL
18x19 mm	92.50 TL
20x22 mm	105.00 TL
21x23 mm	114.50 TL
24x26 mm	131.50 TL
25x28 mm	158.00 TL
27x32 mm	188.00 TL



ELTA - 0150

Çatal İki Ağız Anahtar Takımı

Kısa Boy

8'li	588.60 TL
12'li	1180.50 TL



ELTA - 0356 Kombine Anahtar

6 mm	69.00 TL
7 mm	73.50 TL
8 mm	79.25 TL
9 mm	81.75 TL
10 mm	92.25 TL
11 mm	95.25 TL
12 mm	101.25 TL
13 mm	102.75 TL
14 mm	111.00 TL
15 mm	118.50 TL
16 mm	127.75 TL
17 mm	136.25 TL
18 mm	151.25 TL
19 mm	159.25 TL
20 mm	162.50 TL
21 mm	188.50 TL
22 mm	215.50 TL
24 mm	263.25 TL
27 mm	309.75 TL
30 mm	355.50 TL
32 mm	372.79 TL



ELTA - 0350 Kombine Anahtar Takımı

Kısa Boy

8'li	794.00 TL
------	-----------



ELTA - 0450 Yıldız İki Ağız Anahtar

Kısa Boy

06x07 mm	118.50 TL
08x09 mm	120.20 TL
10x11 mm	133.50 TL
12x13 mm	150.25 TL
14x15 mm	158.00 TL
16x17 mm	178.75 TL
18x19 mm	213.50 TL
20x22 mm	233.25 TL
21x23 mm	267.75 TL
24x26 mm	311.50 TL
25x28 mm	341.00 TL
27x32 mm	376.00 TL



ELTA - 2203 Maşalı Boru Anahtarı

1"	700.00 TL
1 1/2"	1098.50 TL
2"	1637.50 TL



ELTA - 2401 Fort Pense

240 mm	661.00 TL
--------	-----------



ELTA - 2509 Ayarlı Pense

240 mm	637.50 TL
--------	-----------



ELTA - 0511 Iskarpela Düz

6 mm	204.75 TL
8 mm	219.00 TL
10 mm	231.25 TL
12 mm	253.75 TL
14 mm	262.75 TL
16 mm	280.50 TL
18 mm	304.50 TL
20 mm	337.50 TL
22 mm	367.00 TL
24 mm	395.25 TL
26 mm	410.25 TL
30 mm	437.75 TL



ELTA - 3832 Betoncu Kerpeteni

280 mm	653.50 TL
--------	-----------



ELTA - 3021 Kombine Pense

Opak Seri

160 mm	341.75 TL
180 mm	418.25 TL
200 mm	509.50 TL



ELTA - 3701 Yan Keski

Opak Seri

140 mm	324.75 TL
160 mm	381.25 TL



ELTA - 3221 Kargaburun Düz Uçlu

Opak Seri

160 mm	371.71 TL
200 mm	424.75 TL



ELTA - 0601 Kurbağacık

8"	408.50 TL
10"	614.50 TL
12"	812.00 TL



ALTAŞ - Düz Yıldız Anahtar

6x7 mm
8x9 mm
10x11 mm
12x13 mm
14x15 mm
16x17 mm
18x19 mm
20x22 mm
21x23 mm
24x26 mm
25x28 mm
27x32 mm



ALTAŞ - Düz Yıldız Anahtar Takımı

12'li



1513 - Havalı Lokma Ara Kol
1/2" 334.00 TL



1513 - Havalı Lokma Mafsal
1/2" 424.00 TL



1119 - Altıköşe Havalı Lokma Anahtar
19 mm 295.75 TL
21 mm 295.75 TL
22 mm 295.75 TL
24 mm 295.75 TL
27 mm 304.25 TL
30 mm 328.00 TL
32 mm 328.00 TL
34 mm 427.25 TL
36 mm 427.25 TL
41 mm 659.25 TL
46 mm 700.75 TL



1519 - 3/4\"/>



1519 - Havalı Lokma Mafsal
3/4" 1213.00 TL



1519 - Havalı Lokma Adaptör
3/4"Fx1/2"M 420.50 TL



1119 - 3/4\"/>

17 mm	461.50 TL
28 mm	461.50 TL
29 mm	461.50 TL
20 mm	461.50 TL
21 mm	461.50 TL
22 mm	461.50 TL
23 mm	461.50 TL
24 mm	461.50 TL
25 mm	461.50 TL
26 mm	461.50 TL
27 mm	461.50 TL
28 mm	461.50 TL
29 mm	461.50 TL
30 mm	461.50 TL
32 mm	461.50 TL
34 mm	594.00 TL
35 mm	528.75 TL
36 mm	594.00 TL
38 mm	577.00 TL
41 mm	916.50 TL
44 mm	970.00 TL
46 mm	974.25 TL
50 mm	1115.50 TL
55 mm	1269.25 TL
60 mm	1557.75 TL



5049 - Pro Metal Gövde Maket Bıçağı
18 mm 230.75 TL



5052 - Pro Metal Gövde Maket Bıçağı
9 mm 163.50 TL



5088 - Pro Metal Gövde Maket Bıçağı
18 mm 57.75 TL



5089 - Pro Metal Gövde Maket Bıçağı
9 mm 36.50 TL



H - 250 1 225.- TL
Sağ Havalandırma Saç Makas
250x58 mm, 0.38 kg



H - 350 4 770.- TL
Sağ Havalandırma Saç Makas
350x95 mm, 1.15 kg



S - 270a 1 440.- TL
Sağ Düz Saç Makas
270x50 mm, 0.6 kg



H - 300 1 710.- TL
Sağ Havalandırma Saç Makas
300x68 mm, 0.54 kg



H - 400 4 470.- TL
Sağ Havalandırma Saç Makas
400x95 mm, 1.4 kg



S - 270b 1 440.- TL
Sol Düz Sac Makas
270x50 mm, 0.6 kg



T - 250 1 305.- TL
Sağ Sobacı Teneke Makas
250x68 mm, 0.365 kg



M - 240a 990.- TL
Sağ Küçük Düz Saç Makas (Yaylı)
240x45 mm, 0.39 kg



M - 280 1 170.- TL
Sağ Düz Sivri Saç Makas (Yaylı)
280x85 mm, 0.44 kg



T - 300 1 395.- TL
Sağ Sobacı Teneke Makas
300x78 mm, 0.525 kg



M - 240b 990.- TL
Sol Küçük Düz Saç Makas (Yaylı)
240x45 mm, 0.39 kg



M - 290 1 710.- TL
Sağ Küçük Tabaka Makas (Yaylı)
290x85 mm, 0.48 kg



001 - A 10 800.- TL
Sağ Tabaka Saç Makas
550x90 mm, 1.95 kg



002 5 220.- TL
Sağ Düz Saç Makas
340x70 mm, 0.80 kg



003 5 220.- TL
Sol Düz Saç Makas
340x70 mm, 0.80 kg



004 5 760.- TL
Sağ Kavisli Saç Makas
340x70 mm, 0.80 kg



005 5 760.- TL
Sol Kavisli Saç Makas
340x70 mm, 0.80 kg



040 - AS 5 850.- TL
Sağ Inox Apache Makas
360x70 mm, 0.985 kg



041 - AS 5 850.- TL
Sol Inox Apache Makas
360x70 mm, 0.985 kg



071 - AS 1 585.- TL
Sağ Düz Saç Makas
270x50 mm



072 - AS 1 585.- TL
Sol Düz Saç Makas
270x50 mm



010 4 680.- TL
Sağ Sobacı Teneke Makas (No:2)
300x85 mm, 0.7 kg

010 - A 5 760.- TL
Sağ Sobacı Teneke Makas (No:3)
350x95 mm, 0.85 kg

011 6 840.- TL
Sağ Sobacı Teneke Makas (No:4)
400x105 mm, 0.98 kg

012 8 100.- TL
Sağ Sobacı Teneke Makas (No:2)
450x115 mm, 1.5 kg



013 2 340.- TL
Sağ Kavisli Büyük Makas
300x65 mm, 0.55 kg



075-AS 2 610.- TL
Sağ Kavisli Büyük Makas
300x65 mm, 0.435 kg



007 5 220.- TL
Sağ Havalandırma Sac Makas
420x10 mm, 1.5 kg

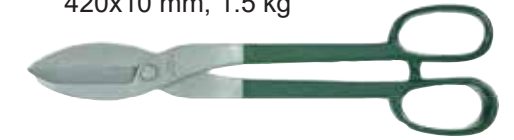

008 5 220.- TL
Sağ Havalandırma Sac Makas
350x100 mm, 1.15 kg



Marangoz işkencesi (Büyük)

20 cm	25412	935.00 TL
30 cm	25413	1000.00 TL
40 cm	25414	1060.00 TL
50 cm	25415	1025.00 TL
60 cm	25416	1185.00 TL
70 cm	25417	1250.00 TL
80 cm	25418	1310.00 TL
90 cm	25419	1375.00 TL
100 cm	25420	1450.00 TL
120 cm	25422	1560.00 TL
150 cm	25425	1750.00 TL
200 cm	25426	2120.00 TL



Marangoz işkencesi (Küçük)

150x80 mm	25452	495.00 TL
200x80 mm	25453	520.00 TL
250x80 mm	25454	560.00 TL
300x80 mm	25455	595.00 TL
350x80 mm	25456	625.00 TL
400x50 mm	25457	660.00 TL
500x50 mm		735.00 TL

Marangoz işkencesi (Küçük)

200x80 mm	MK4310	7.30 \$
250x80 mm	MK4312	7.70 \$
300x80 mm	MK4314	7.90 \$
400x80 mm	MK4316	8.10 \$
500x80 mm	MK4318	8.60 \$
600x80 mm	MK4320	9.00 \$



Marangoz işkencesi (Minik)

150x50 mm	MK4300	4.45 \$
200x50 mm	MK4302	5.00 \$
300x50 mm	MK4304	5.40 \$
400x50 mm	MK4306	5.80 \$
500x50 mm	MK4307	6.60 \$
600x50 mm	MK4308	7.10 \$



Mengene Seti 3'lü

MK4255 6.00 \$



Boru Mengenesi

2"	2585.00 TL
3"	3135.00 TL
4"	4290.50 TL



Çelik Döküm Tezgaah Mengenesi (SABİT)

100 mm - 6.5 kg	31320	4 215.- TL
125 mm - 8.5 kg	31340	5 185.- TL
135 mm - 12 kg	31350	5 835.- TL
150 mm - 16.5 kg	31360	7 350.- TL
175 mm - 21.5 kg	31370	8 860.- TL
200 mm - 24 kg	31380	10 150.- TL

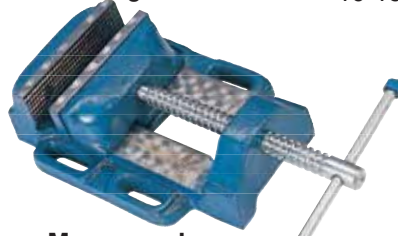

Matkap Mengenesi

100 mm - 6 kg	31210	3 565.- TL
125 mm - 8 kg	31220	4 535.- TL
150 mm - 15 kg	31230	5 510.- TL
175 mm - 18 kg	31241	7 235.- TL
200 mm		8 140.- TL



Sabit Tezgaah Mengenesi

75 mm	MK4191	43.00 \$
100 mm	MK4192	47.30 \$
125 mm	MK4193	65.70 \$
150 mm	MK4194	98.80 \$
200 mm	MK4195	141.00 \$

Sabit Tezgaah Mengenesi

75 mm	MES 134	47.50 \$
100 mm	MES 133	52.50 \$
125 mm	MES 132	68.50 \$
150 mm	MES 131	105.00 \$
200 mm	MES 130	150.00 \$



Dönerli Tezgaah Mengenesi

75 mm	MES 129	58.50 \$
100 mm	MES 128	63.00 \$
125 mm	MES 127	85.87 \$
150 mm	MES 126	129.35 \$



Mini Masa Mengenesi

50 mm	MK4200	18.53 \$
60 mm	MK4210	19.25 \$
70 mm	MK4220	19.90 \$
80 mm	MK4230	22.80 \$



Eko Kombine Kraft Pense

160 mm	4.50 \$
180 mm	5.00 \$
200 mm	5.40 \$



Eko Yan Keski

160 mm	4.50 \$
180 mm	
200 mm	



Eko Kargaburun Uzun Sivri

160 mm izole	21841	4.50 \$
200 mm izole	21843	4.50 \$



Eko Elektronikçi Mini Yan Keski

115 mm	2.80 \$
--------	---------

Eko Elektronikçi Mini Kombine Pense

115 mm	2.80 \$
--------	---------

Eko Elektronikçi Mini Kargaburun

115 mm	2.80 \$
--------	---------



Eko Sekman Pense Seti 19.06 \$



Kombine Anahtar Seti

12 Parça	45.47 \$
8-10-12-13-14-17-19 mm	



Zincirli Filtre Sökeceği 9.57 \$

Kayıslı Filtre Sökeceği 7.98 \$



Düz Bits Uçlar

SL6x25 mm	5250	0.15 \$
SL6x50 mm	5251	0.24 \$
SL6x75 mm	5252	0.37 \$

Düz Bits Uçlar

No: 1x50 mm	MU1830	0.24 \$
-------------	--------	---------



Yıldız Bits Uçlar

PH1x25 mm	24862	0.16 \$
PH1x50 mm	5200	0.23 \$
PH1x75 mm	5201	0.37 \$
PH1x100 mm	5202	0.64 \$
PH1x150 mm	5203	0.88 \$

PH2x25 mm	5205	0.13 \$
PH2x50 mm	5206	0.23 \$
PH2x75 mm	5207	0.37 \$
PH2x100 mm	5209	0.64 \$
PH2x150 mm	5210	0.88 \$
PH2x200 mm	5212	1.35 \$

PH3x50 mm	5215	0.23 \$
PH3x75 mm	5216	0.37 \$

Yıldız Bits Uçlar

PH2x25 mm	MU1840	0.15 \$
PH2x50 mm	MU1850	0.24 \$
PH2x75 mm	MU1860	0.37 \$
PH2x100 mm	MU1870	0.55 \$
PH2x150 mm	MU1880	0.80 \$
PH2x200 mm	MU1890	1.15 \$



Pozidriv Bits Uçlar

PZ1x50 mm	5220	0.23 \$
PZ1x75 mm	5221	0.37 \$
PZ2x25 mm	5225	0.13 \$
PZ2x50 mm	5226	0.23 \$
PZ3x50 mm	5230	0.23 \$
PZ3x75 mm	5227	0.37 \$
PZ2x75 mm	5228	0.37 \$
PZ2x100 mm	5239	0.64 \$
PZ2x150 mm	5231	0.88 \$

Pozidriv Bits Uçlar

PZ1x50 mm	MU1900	0.24 \$
PZ2x25 mm	MU1910	0.15 \$
PZ2x50 mm	MU1920	0.24 \$
PZ2x75 mm	MU1930	0.37 \$
PZ2x100 mm	MU1940	0.55 \$
PZ2x150 mm	MU1950	0.80 \$
PZ2x200 mm	MU1960	1.15 \$



Bits Uç Yuvarlak Yıldız

PH 2x50	MU2060	0.30 \$
---------	--------	---------



Torks Bits Uçlar

T10x50 mm	5235	0.23 \$
T15x50 mm	5236	0.23 \$
T20x50 mm	5237	0.23 \$
T25x50 mm	5238	0.23 \$
T27x50 mm	5239	0.23 \$
T30x30 mm	5240	0.16 \$
T30x50 mm	5241	0.23 \$
T30x75 mm	5242	0.37 \$
T30x100 mm	5243	0.64 \$
T30x150 mm	5244	0.88 \$

Torks Bits Uçlar

T30x50 mm	MK1970	0.24 \$
T30x75 mm	MK1980	0.37 \$
T30x100 mm	MK1990	0.55 \$
T30x150 mm	MK2000	0.80 \$



Manyetik Somun Lokması

8x45 mm	MU2170	0.36 \$
8x65 mm	MU2172	0.44 \$
10x45 mm	MU2180	0.39 \$
11x45 mm	MU2181	0.47 \$
12x45 mm	MU2182	0.47 \$
13x48 mm	MU2190	0.52 \$
14x65 mm	MU2191	0.72 \$

Manyetik Somun Lokması

7x45 mm	2545	0.40 \$
8x45 mm	2546	0.40 \$
10x45 mm	2547	0.45 \$
11x45 mm	2548	0.56 \$
12x45 mm	2549	0.56 \$
13x48 mm	2550	0.58 \$
14x65 mm	2552	1.00 \$
17x65 mm	2553	2.00 \$



Derin Manyetik Somun Lokması

8 mm	MU2340	1.65 \$
10 mm	MU2350	1.70 \$
13 mm	MU2360	1.80 \$



Derin Manyetik Somun Lokması Ekstra Uzun

8X150 mm	2554	2.20 \$
----------	------	---------



SDS Plus Manyetik Somun Lokması

8 mm	MU2310	1.65 \$
10 mm	MU2320	1.70 \$
13 mm	MU2330	1.80 \$



1/2" Tork Lokmalı Bits Uç Kısa

T20 - 55	2430	2.15 \$
T25 - 55	2431	2.15 \$
T27 - 55	2432	2.15 \$
T30 - 55	2433	2.15 \$
T35 - 55	2434	2.15 \$
T40 - 55	2435	2.15 \$
T45 - 55	2436	2.15 \$
T50 - 55	2437	2.15 \$
T55 - 55	2438	2.15 \$
T60 - 55	2439	2.45 \$



1/2" Allen Lokmalı Bits Uç Uzun

HEX - 4x100 mm	2448	2.55 \$
HEX - 5x100 mm	2449	2.55 \$
HEX - 6x100 mm	2450	2.55 \$
HEX - 8x100 mm	2451	2.55 \$
HEX - 10x100 mm	2452	2.55 \$
HEX - 12x100 mm	2453	3.20 \$

1/2" Allen Lokmalı Bits Uç Kısa

HEX - 4x55 mm	2440	2.15 \$
HEX - 5x55 mm	2441	2.15 \$
HEX - 6x55 mm	2442	2.15 \$
HEX - 7x55 mm	2443	2.15 \$
HEX - 8x55 mm	2444	2.15 \$
HEX - 10x55 mm	2445	2.15 \$
HEX - 12x55 mm	2446	2.15 \$
HEX - 14x55 mm	2447	2.45 \$



Bits Uç Uzatma Adaptörü

60 mm	2560	0.40 \$
100 mm	2561	0.65 \$
150 mm	2562	0.85 \$

Bits Uç Uzatma Adaptörü

60 mm	MU2210	0.40 \$
-------	--------	---------



SDS Bits Uç Adaptörü

MU2302		0.60 \$
--------	--	---------

SDS Bits Uç Adaptör

2556		0.91 \$
------	--	---------



Şapkalı Bits Uç

MU2301		0.25 \$
--------	--	---------

Şapkalı Bits Uç

2557		0.24 \$
------	--	---------

HEX Lokma Adaptör

HEX - 1/2x73 mm	2565	1.20 \$
HEX - 1/4x65 mm	2566	0.75 \$



SDS Lokma Adaptör

SDS - 1/2x65mm	MU2156	1.35 \$
----------------	--------	---------

SDS Lokma Adaptör (Eko)

SDS - 1/4x65mm	2564	1.40 \$
SDS - 1/2x73mm	2563	1.50 \$



SDS Plus Lokma Adaptörü

1/2x65 mm	MU2156	1.35 \$
-----------	--------	---------



SDS Plus Mandren Adaptörü

1/2x65 mm	MU2160	0.71 \$
-----------	--------	---------

SDS Plus Mandren Adaptörü

1/2x65 mm	MES 618	0.82 \$
-----------	---------	---------

SDS Plus Mandren Adaptörü

1/2x65 mm	2795	0.80 \$
-----------	------	---------



SDS Plus Mandren Adaptörü

15701		0.80 \$
-------	--	---------



SDS Max - SDS Plus Adaptörü

15705		17.70 \$
-------	--	----------



Bits Tutucu Tornavida

6x110 mm	MK4499	1.55 \$
----------	--------	---------



Allen Otomotiv Bits Uç Kısa

HEX - 5x30 mm	2468	0.55 \$
HEX - 6x30 mm	2469	0.55 \$
HEX - 7x30 mm	2470	0.55 \$
HEX - 8x30 mm	2471	0.55 \$
HEX - 10x30 mm	2472	0.55 \$
HEX - 12x30 mm	2473	0.70 \$



Allen Otomotiv Bits Uç Uzun

HEX - 5x75 mm	2474	1.05 \$
HEX - 6x75 mm	2475	1.05 \$
HEX - 7x75 mm	2476	1.05 \$
HEX - 8x75 mm	2477	1.05 \$
HEX - 10x75 mm	2478	1.05 \$
HEX - 12x75 mm	2479	1.35 \$



Allen Altıköşe Bits Uç

HEX 3-50	2480	0.27 \$
HEX 4-50	2481	0.27 \$
HEX 5-50	2482	0.27 \$
HEX 6-50	2483	0.27 \$



TYSON Mıknatıslı Bits Uç

Çift Yön PH2x65	TYS9681	59.00 TL
Çift Yön PZ2x65	TYS9682	59.00 TL



TYSON Mıknatıslı Bits Uç

Tek Yön PH2x65	TYS9683	59.00 TL
Tek Yön PZ2x65	TYS9684	59.00 TL



Vidalama Köşe

Adaptörü MES 4160 8.15 \$



Otomotiv Bits Seti

40 pcs MU2155 36.50 \$

Otomotiv Bits Seti

40 pcs MES 016 44.00 \$

Otomotiv Bits Seti

40 pcs 5260 36.50 \$



Tork Otomotiv Bits Uçlar

T20 10x30 mm	MU2080	0.53 \$
T25 10x30 mm	MU2081	0.53 \$
T30 10x30 mm	MU2082	0.53 \$
T40 10x30 mm	MU2083	0.53 \$
T45 10x30 mm	MU2084	0.53 \$
T20 10x75 mm	MU2088	1.05 \$
T25 10x75 mm	MU2089	1.05 \$
T30 10x75 mm	MU2090	1.05 \$
T40 10x75 mm	MU2091	1.05 \$
T45 10x75 mm	MU2092	1.05 \$
T50 10x75 mm	MU2093	1.05 \$
T55 10x75 mm	MU2094	1.05 \$

Allen Otomotiv Bits Uç

H8-10x75 mm MU2105 1.05 \$

Akrobat Esnek Tornavida Ucu Aparatı
30 cm MES 961 2.28 \$

Akrobat Bits Uzatma
12" - 300 mm MU2220 2.30 \$
Bükülebilir Bits Uzatma 3.60 \$



Akrobat Esnek Tornavida Ucu Seti
12 parça, 30 cm MES 962 4.35 \$

Akrobat Bits Uzatma Seti
12 Parça MU2230 4.20 \$
12" - 300 mm



Kontrol Kalemi
Yıldız 190 mm MK4420 0.81 \$

Kraft Kontrol Kalemi
Düz Mini 140 mm MK4410 0.78 \$
Düz Mini 178 mm MK4440 0.70 \$
Düz 140 mm MK4430 0.55 \$
Düz 190 mm MK4410 0.78 \$

Kontrol Kalemi
Düz 190 mm MES 630 0.92 \$



Tornavida Seti
7 parça MK4508-04 6.75 \$

Tornavida Seti
12 parça MK4508-08 11.94 \$



Tornavida Seti
6 parça MK4508-12 6.40 \$

Tornavida Seti
5 parça MK4508-16 11.10 \$



410 ml - Döküm Gövde
23772 15.35 \$



Silikon Tabancası Plastik Profesyonel MK0556 2.60 \$



Köpük Tabancası
MK0576 11.60 \$



Boya Karıştırıcı M14 Vidalı
12x600 mm MK0572 4.60 \$



Boya Karıştırıcı SDS Plus
80 x 400 mm MK0568 2.67 \$
100 x 500 mm MK0569 3.37 \$
120 x 600 mm MK0570 4.10 \$



Kontrol Kalemi Dijital MK4460 1.10 \$



Yaylı Miknatıs
1.5 lb MK4190 3.58 \$



Tornavida Bits Uç Seti
31 Parça 3.50 \$



Tornavida Düz Uçlu
4x100 mm MK4463 0.67 \$
4x125 mm MK4464 0.71 \$
4x150 mm MK4465 0.75 \$
5x100 mm MK4466 0.76 \$
5x125 mm MK4467 0.81 \$
5x150 mm MK4468 0.86 \$
5x300 mm MK4469 1.21 \$
6x100 mm MK4470 0.91 \$
6x125 mm MK4471 0.97 \$
6x150 mm MK4472 1.03 \$
8x200 mm MK4489 1.78 \$



Tornavida Yıldız Uçlu
4x100 mm MK4477 0.67 \$
4x125 mm MK4478 0.71 \$
4x150 mm MK4479 0.75 \$
5x100 mm MK4480 0.76 \$
5x125 mm MK4481 0.81 \$
5x150 mm MK4482 0.86 \$
5x300 mm MK4483 1.21 \$
6x100 mm MK4484 0.91 \$
6x125 mm MK4485 0.97 \$
6x150 mm MK4486 1.03 \$
8x200 mm MK4490 1.78 \$



Tornavida Torx Uçlu
T 10 MK4491 0.79 \$
T 15 MK4493 0.79 \$
T 20 MK4494 0.79 \$
T 25 MK4495 0.97 \$
T 27 MK4496 0.97 \$
T 30 MK4497 0.97 \$
T 40 MK4498 1.00 \$



Lokma Tornavida
6 mm MK4501 1.81 \$
7 mm MK4502 1.81 \$
8 mm MK4503 1.81 \$
9 mm MK4504 1.90 \$
10 mm MK4505 1.90 \$
11 mm MK4506 2.45 \$
12 mm MK4507 2.45 \$
13 mm MK4508 2.45 \$



Klemens Tornavida Düz
3x80 mm MK4461 0.53 \$

Klemens Tornavida Yıldız
3x80 mm MK4462 0.53 \$



Topaç Tornavida
Düz 6x38 mm MK4487 0.61 \$
Yıldız 6x38 mm MK4488 0.61 \$



1/4" Lokma Takımı
58 Parça MES 024 71.35 \$



1/2" Lokma Takımı
24 Parça MES 018 111.82 \$



1/4" Uzun Lokma Takımı
9 Parça MK2700 17.40 \$



3/8" Uzun Lokma Takımı
10 Parça MK2710 22.80 \$

1/2" Tork Lokma Takımı
9 Parça MK2740 23.20 \$



1/2" Lokma Takımı
62 Parça MK2635 106.00 \$



Circir Kolu
1/2" MES 4390 21.30 \$

Circir Kolu
1/4" MES 4392 12.35 \$



1/2" Tekli Havalı Lokma
10 mm MES 864 2.92 \$
13 mm MES 865 3.08 \$
17 mm MES 866 3.19 \$
19 mm MES 867 3.62 \$
21 mm MES 868 3.94 \$
22 mm MES 869 4.26 \$
24 mm MES 870 5.11 \$



1/2" Tekli Havalı Uzun Lokma
10 mm 6.92 \$
13 mm 6.97 \$
17 mm 7.88 \$
19 mm 7.98 \$
21 mm 8.09 \$
22 mm 8.53 \$
24 mm 9.10 \$



1/2" Lokma Uzun
19 mm MK2958 3.95 \$



1/2" Lokma Kısa
10 mm MK2900 1.55 \$
13 mm MK2906 1.65 \$
17 mm MK2914 1.95 \$
21 mm MK2920 2.40 \$



1/2" Uzatma Kolu
75 mm MES 079 4.68 \$
250 mm MES 078 8.89 \$



1/2" Oynar Mafsals
3/4 Fx1/2 M MK3060 7.35 \$



Yükseltici Düşürücü Lokma Adaptör
3/4 Fx1/2 M MES084 7.72 \$



1/2" T Kol
250 mm MES 076 10.65 \$



3'lü T Lokma Adaptör
8-10-13 mm MK2530 6.00 \$



3/8" Lokma Takımı
62 Parça MES 025 109.60 \$



1/2" Fırdöndülü Lokma Takımı
24 Parça MES 020 116.00 \$

1/4"-1/2" Lokma Takımı
60 Parça MES 023 126.73 \$

1/4"-1/2" Lokma Takımı
95 Parça MES 027 167.00 \$



1/2" Lokma Takımı
63 Parça MES 026 142.00 \$



Eltos EET001 363.00 TL
Epoksi Tabanca 345 ml



Eltos EYT338 356.00 TL
Yekpare Silikon Tabancası
Kancalı



Eltos PST339 116.00 TL
Kendo Plastik Silikon Tabancası



Eltos PET003 139.00 TL
Kendo Plastik Epoksi Dübel Tabancası
345 ml



Eltos ES332 25.00 TL
Ergonomik Eğe Sapı
Düz
Motorcu ES333 25.00 TL



Eltos EK520 100.00 TL
El Kantarı
12.5 kg
25 kg EK521 123.00 TL
50 kg EK522 193.00 TL



Eltos EEA 622 149.- TL
Çoklu Anahtar Edoni Poşetli



Eltos HKP 220 515.00 TL
Hortum Kelepçe Pensesi
220 mm



Eltos EOI 150 449.00 TL
Otomatik İşkence
150 mm
300 mm EOI 300 581.00 TL
450 mm EOI 450 726.00 TL
600 mm EOI 600 871.00 TL
750 mm EOI 750 1017.00 TL
900 mm EOI 900 1160.00 TL



Eltos ETA 002 38.50 TL
T Saplı Allen Anahtar
2 mm
2.5 mm ETA 025 43.50 TL
3 mm ETA 003 50.15 TL
4 mm ETA 004 60.75 TL
5 mm ETA 005 79.00 TL
6 mm ETA 006 119.00 TL
8 mm ETA 008 178.00 TL
10 mm ETA 010 245.00 TL



Eltos EI 006 238.70 TL
İskarpela
6 mm
8 mm EI 008 251.00 TL
10 mm EI 010 304.00 TL
12 mm EI 012 330.00 TL
14 mm EI 014 370.00 TL
16 mm EI 016 383.00 TL
18 mm EI 018 423.00 TL
20 mm EI 020 448.00 TL
22 mm EI 022 475.00 TL
25 mm EI 025 502.00 TL



Eltos EIS004 1085.00 TL
İskarpela Seti
4 parça



Eltos EAT065 121.00 TL
Profesyonel Ağaç Tokmak
65 mm
75mm EAT075 131.00 TL



Eltos EAT060 93.00 TL
Ağaç Tokmak
60 mm



Eltos EAT848 81.50 TL
Edoni Ergonomik Lastik Tokmak
50 mm
60mm EAT849 95.00 TL



Eltos EHC500 90.00 TL
Plastik Hassas Çekiç
No : 500
No : 1000 EHC1000 119.00 TL
No : 1500 EHC1500 151.00 TL
No : 2000 EHC2000 172.00 TL



Eltos EVT833 117.00 TL
Vidalı Plastik Saplı Tokmak
40 mm
50mm EVT834 137.00 TL



Eltos EVT830 185.00 TL
Vidalı Plastik Tokmak Çekiç
30 mm
40 mm EVT831 232.00 TL
40 mm EVT832 300.00 TL



Eltos VTY030 21.15 TL
Vidalı Plastik Tokmak Yedeği
30 mm
40 mm VTY040 26.50 TL
40 mm VTY050 33.00 TL



Eltos PD102 400.00 TL
Profesyonel Testere Kolu



Eltos HD101 126.00 TL
Hobby Testere Kolu



Eltos CD100 196.00 TL
Klasik Demir Testere Kolu
Plastik Sap



Eltos LD107 259.00 TL
Ağızlı Lama Testere Kolu



Eltos MDT 300 81.60 TL
Mini Demir Testere Kolu



Eltos KDA 620 221.00 TL
Kil Testere Ağızı



Eltos DDA610 14.40 TL
Dar Testere Ağızı Çift Taraflı



Eltos JAT 115 138.00 TL
JAWS Ahşap Daire Testere



Eltos KAS 006 288.- TL
Kovan Anahtar Seti
6 Parça



Eltos EBA 001 92.40 TL
Edoni Bisiklet Anahtarı



Eltos KAS 901 144.- TL
Kendo Alyan Anahtar Seti (Allen)
Vakumlu



Eltos Jaws Uzun Allen Anahtar Seti
Altılışe - 9 Parça JAS 151 316.80 TL
Torx - 9 Parça JAS 150 504.00 TL
Yuvarlak - 9 Parça JMA 180 504.00 TL



Eltos T Allen Anahtar Seti
Torx - 6 Parça TAS 006 705.- TL
Hex - 7 Parça TAS 007 632.- TL



Eltos Ergonomik Derz Spatulası
Siyah EFS 101 34.80 TL



Eltos EDK 001 82.80 TL
Derz Kazıcı



Eltos CKS 001 31.80 TL
Cam Kazıma Bıçağı



Eltos CKS 002 119.00 TL
Profesyonel Cam Kazıma Bıçağı

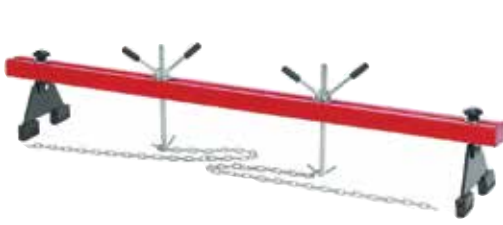

Motor Askı Aparatı



Mekanik İnce Yağ Pompası Çevirmeli 4118, 18 Lt

Havalı Gres Pompası 4530
30 kg, 45/1 sıkıştırma oranı, 5-10m h hortum takılabilir.



Metal Takım Çantası

300x200x150 mm -3 göz	25210	1560.00 TL
300x200x200 mm -5 göz	25220	1680.00 TL
420x200x150 mm -3 göz	25230	1680.00 TL
420x200x200 mm -5 göz	25240	1860.00 TL
520x200x150 mm -3 göz	25250	1860.00 TL
520x200x200 mm -5 göz	25260	2040.00 TL
600x200x200 mm -5 göz	25270	2400.00 TL



Katlanır Motor Toplama Standı



Araba Sehpa (Çift fiyatdır)
3 ton MK0490 42.40 \$
6 ton MK0491 70.00 \$



Mekanik Sıvı Transfer Pompası Varip Tipi Çevirmeli 4100, 208 Lt 30 - \$

Mekanik Sıvı Transfer Pompası Varil Tipi Basmalı 4150, 208 Lt 55.- \$

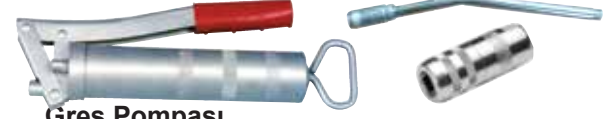

Gres Pompası

300 cc	23910	650.00 TL
400 cc	23915	650.00 TL
500 cc	23920	660.00 TL
1000 cc	23923	1080.00 TL



4 Tırnaklı Uç 23930 66.00 TL

Kaval Borusu 23940 48.00 TL

Pompa Hortumu, 40 cm 23950 125.00 TL



Gres Pompası

500 cc MK1310 13.50 \$

Gres Pompası

500 cc MES 4115 16.70 \$



Gres Pompası 2 Pistonlu

500 cc MK1312 18.00 \$

Gres Tabancası Çift Pistonlu

600 cc MES 4116 24.50 \$



Takım Arabası Demonte 3 Katlı



Takım Arabası 5 Çekmeceli 5 750.- TL



Mekanik Gres Pompası Basmalı 3025

20 kg 188.- \$



Köpük Püskürtme Pompası 9060 60 Lt 265.- \$

Köpük Püskürtme Pompası 9090 80 Lt 273.- \$



İtmeli Yağ Pompası

İnce Yağ Pompası 24110 650.00 TL

Gres Yağ Pompası 24120 650.00 TL



Metal Yağdanlık

250 cc 24310 215.00 TL

350 cc 24320 230.00 TL

500 cc 24330 240.00 TL

1000 cc 24340 325.00 TL



Spiralli Yağdanlık

400 cc 24510 230.00 TL

500 cc MK1320 3.60 \$



Çalışma Tezgahı
BD361531
H2080 x W2500 x D730 mm

Çalışma Tezgahı
BD361566
H2050 x W730 x D1400 mm



Askılı Tel Sepet
BD361658
H100 x W300 x D200 mm



Evrak Rafı
BD361643
H40 x W310 x D220 mm



Metal Faf
BD361648
H30 x W200 x D150 mm

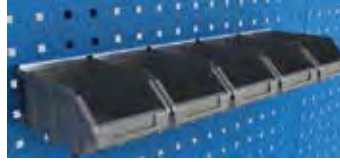

Askılı Avadanlık
BD361645
H74 x W102 x D170mm dış,
H70 x W90 x D150mm iç

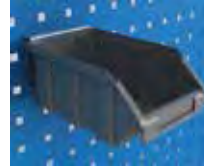

Askılı Avadanlık Tekli
BD361646
H74 x W102 x D170mm
dış, H70 x W90 x D150mm iç



Pano Kanca İkili
BD361650
40 mm

Pano Kanca İkili Uzun
BD361657
80 mm



Sprey Askısı
BD361654



Testere Askısı
BD361641



Alyan Anahtar Askısı
BD361644



Çalışma Tezgahı
BD361526
H2080 x W3000 x D730 mm

Çalışma Tezgahı
BD361527
H2080 x W1950 x D730 mm



Pano Kanca 80mm
BD361651

Pano Kanca 40mm
BD361656



Pano Kanca Kare
BD361653

Pano Kanca U
BD361652



Çoklu Kanca
BD361649



Tornavida Askısı
BD361655



Çalışma Tezgahı
BD361534
H2080 x W2000 x D730 mm

Çalışma Tezgahı
BD361561
H2080 x W3000 x D730 mm



Matkap Ucu Askısı
BD361642

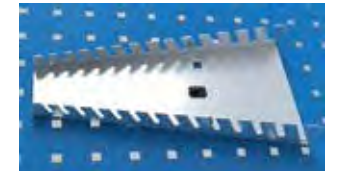

Açık Ağızlı Anahtar Askısı
BD361647



Dosya Dolapları

BD214532 - (H1980xW920xD400mm)

BD214533 - (H1300xW920xD400mm)

BD214532 - (H1000xW920xD400mm)

Emanet Dolapları

BD213405 - 5 Gözlü (H1750xW410xD400mm)

BD213410 - 10 Gözlü (H1750xW800xD400mm)

BD213415 - 15 Gözlü (H1750xW1170xD400mm)

Kartoreks Dolapları

BD215414 - 4'lü (H1300xW460xD620mm)

BD215413 - 3'lü (H1000xW460xD620mm)

BD215412 - 2'li (H700xW460xD620mm)



Soyunma Dolapları

BD215278 - 6'lı (H2000xW1170xD400mm)

BD215282 - 4'lü (H2000xW800xD400mm)

BD215284 - 3'lü (H1850xW1170xD400mm)

BD215293 - 2'li (H1850xW800xD400mm)

BD215271 - Tekli (H1850xW400xD400mm)

Ranzalar

BD215822 - Yurt Tipi Çift Katl (W1900xD900mm)

BD215832 - Yurt Tipi Çift Katl (W1900xD900mm)

BD215821 - Yurt Tipi Çift Katl (W1900xD900mm)

BD215826 - Ranza Korkulu

BD215826 - Ranza Merdiveni

BD215826 - Ranza Suntas (W1800xD900mm)



İnfoline Ayaklı 6'lı



İnfoline Ayaklı Tabanlı 6'lı



İnfoline Duvar tipi 6'lı

İnfoline Masaüstü Sabit

A-4 Çerçeve için aparat

İnfoline Masaüstü Hareketli

A-4 Çerçeve için ayak



İnfoline A4 Çerçeve ve Asetatı 5'li



Plastik Takım Çantası

13" Tool box Organizerli - CO-13	25310	132.00 TL
16" Tool box Organizerli - CO-16	25313	225.00 TL
18" Tool box Organizerli - CO-18	25315	340.00 TL
21" Tool box Organizerli - CO-21	25320	495.00 TL

21" Taşınabilir Organizerli Çekmeceli - RLO-21

25321	615.00 TL
-------	-----------

13" Tool box Metal Kilitli - MT-13	195.00 TL
16" Tool box Metal Kilitli - MT-16	330.00 TL
19" Tool box Metal Kilitli - MT-19	465.00 TL
22" Tool box Metal Kilitli - MT-22	765.00 TL
26" Tool box Metal Kilitli - MT-26	935.00 TL

Tekerlekli Takım Çantası - TPK-28

38510	1485.00 TL
-------	------------

13" Organizer



163.00 TL

18" Organizer

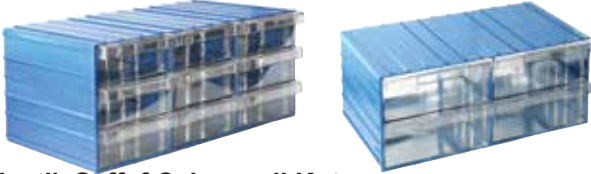

214.00 TL

Plastik Şeffaf Çekmeceli Kutu

105 - 110x65x170 mm - 351	52.00 TL
120 - 120x80x200 mm - 401A	81.00 TL
140 - 140x95x230 mm - 500 A	115.00 TL
175 - 175x110x230 mm - 451	144.00 TL



SPK 6011

A500

Plastik Avadanlıklar - GRİ

A 100 - 102x73x160 mm	13.50 TL
A 150 - 130x100x200 mm	29.30 TL
A 200 - 146x125x230 mm	44.50 TL
A 250 - 180x135x283 mm	61.00 TL
A 300 - 212x145x345 mm	79.65 TL
A 350 - 262x170x405 mm	120.00 TL
A 400 - 308x187x458 mm	164.00 TL
A 500 - 490x300x400 mm	238.00 TL

Plastik Kasa SPK 6011

259.00 TL

Plastik Kasa Kapağı SPK 6011

160.00 TL

Plastik Ara Bölme

105 - 110x65x170 mm - 351	4.45 TL
120 - 120x80x200 mm - 401A	6.10 TL
140 - 140x95x230 mm - 500 A	7.70 TL
175 - 175x110x230 mm - 451	10.95 TL



5 - Ray Dayama

1 - Virgül Dayama

9 - Bombeli Kama Dayama



3 - Dil Dayama



8 - Ökçe Dayama



2 - Kama Dayama



5 - Tabaka Dayama



6 - Kelebek Dayama



4 - Topuz Dayama



10 - Büyük Virgül Dayama

Kaportacı Dayamalar

AD007 - Ray	21601	910.- TL
AD001 - Virgül	21320	910.- TL
AD009 - Bombeli Kama	21630	875.- TL
AD003 - Dil	21640	850.- TL
AD008 - Ökçe	21650	850.- TL
AD002 - Kama	21660	850.- TL
AD005 - Tabaka	21670	850.- TL
AD006 - Kelebek	21680	850.- TL
AD004 - Topuz	21690	850.- TL
AD010 - Büyük Virgül	21621	1135.- TL

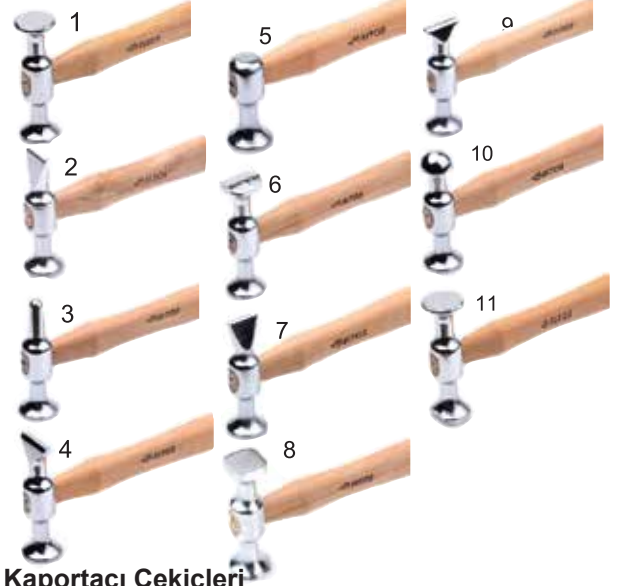

Kaportacı Çekiçleri

EKÇ 001	828.- TL
EKÇ 002	828.- TL
EKÇ 003	828.- TL
EKÇ 004	828.- TL
EKÇ 005	828.- TL
EKÇ 006	828.- TL
EKÇ 007	828.- TL
EKÇ 008	828.- TL
EKÇ 009	828.- TL
EKÇ 010	828.- TL
EKÇ 011	828.- TL
KCS030 Kaportacı Çekiç Sapı	81.- TL



Kaportacı Oto Doğrama Takımı

Ray, virgül, ökçe, topuz, kelebek, tabaka, dil, bombeli tabaka, kama dayama, No:5 - No:11 çekiç

21710

7 940.- TL

Eko Allen Anahtarlar

Isıl işlemsiz montaj amaçlı

2 mm	60501	1.15 TL
2.5 mm	60502	1.15 TL
3 mm	60503	1.15 TL
4 mm	60504	1.65 TL
5 mm	60505	3.75 TL
6 mm	60506	4.00 TL
7 mm	60507	12.00 TL
8 mm	60508	14.25 TL
10 mm	60510	29.25 TL
12 mm	60512	33.00 TL



Kıl Destere Kolu (Yedek Ağızlı)

150 mm MK4698 1.42 \$



Demir Testere Kolu Döküm

300 mm MK4694 3.45 \$



Demir Testere Ağızı

300x25x0.8 mm MK4700 0.25 \$
300x12x0.6 mm 61692 0.23 \$
50 Adet/paket



Kıl Testere Seti

8 Parça MES 598 7.10 \$

Kıl Testere Seti

6 Yedek Ağızlı MK4699 6.00 \$



PASS P37 Strafor Yapıştırıcı

480 gr 1.62 €



Koruyucu Hişir Örtü

4x5 mt (20 m²) 34.00 TL
4x8 mt (32 m²) 52.00 TL
4x12.5 mt (50 m²) 73.00 TL



Kalın Zemin Örtüsü

4x5 mt (20 m²) 55.00 TL
4x8 mt (32 m²) 76.00 TL
4x12.5 mt (50 m²) 115.00 TL



Trafik Emniyet Bandı

Kırmızı - Beyaz 67.00 TL
Küçük boy - 110 mt

Kırmızı - Beyaz 130.00 TL
Büyük boy - 250 mt

Kırmızı - Beyaz 183.00 TL
Büyük boy - 350 mt

Doğalgaz İkaz Bandı

Sarı - Siyah 180.00 TL
Küçük boy - 175-250 mt



Eko Selülozik Tiner

1/2 Lt - 0.350 gr 110.00 TL
1/1 - 0.700 gr 181.00 TL
Galon 3/1 Lt - 2100 gr 430.00 TL
Teneke 10 Lt - 8.50 kg 1320.00 TL

Eko Sentetik Tiner

1/2 Lt - 256 ml 50.00 TL
1/1 - 1250 ml 86.00 TL
2/1 - 1925 ml 208.00 TL
3/1 - 1500 Gr 308.00 TL
Teneke 10 Lt - 7.80 kg 1550.00 TL



Poliüretan Fayansçı Dizlik

14 cm 690 154.- TL/çift

Usta Tipi Dizlik 330.- TL/çift

D FINRU
12345
67890

Krom Harf ve Rakam

Küçük Boy - 2.5 cm 12.90 TL
Orta Boy - 3.75 cm 15.50 TL
Büyük Boy - 5 cm 17.95 TL

12345
67890

İtalik Rakam

Krom - 5 cm 21.60 TL
Saten - 5 cm 21.60 TL

12345
67890

Dekoratif Rakam

Krom - 5.5 cm 34.75 TL
Saten - 5.5 cm 34.75 TL

12345
67890

Villa Boy Rakam

Krom - 8.5 cm 61.56 TL



Vakumlu Askı 2'li

Krom 86.58 TL



Vakumlu Yuvarlak Havluluk

Krom 326.00 TL

Vakumlu Uzun Havluluk

Krom 410.00 TL



Akdemir

Vakumlu WC Kağıtlık 234.00 TL

Akdemir

Vakumlu Havlu Peçetelik 294.00 TL



Zebra Yönlendirme

Büyük, 8.5x13 cm 77.50 TL



Eko Plastik Çekiç

No: 30	20910	121.00 TL
No: 40	20920	156.00 TL
No: 50	20930	208.00 TL



Plastik Çekiç Yedek

No: 30	21010	13.58 TL
No: 40	21020	18.30 TL
No: 50	21030	24.40 TL



Şeffaf Plastik Çekiç

No:40 156.00 TL



Şeffaf Plastik Çekiç Yedek

No:40



Lastik Tokmaklar

No: 40	20510	135.00 TL
No: 70	20540	249.00 TL



Betoncu Kerpeteni

280 mm 7.30 \$



Maşalı Boru Anahtarı

1" 11.00 \$
1.5" 15.00 \$



Siil -Odun Kaması



Balyozlar

3 kg	20541	335.00 TL
4 kg	20542	450.00 TL
5 kg	20543	565.00 TL
6 kg		680.00 TL

Sivri Balyozlar

3 kg	20546	335.00 TL
4 kg	20547	450.00 TL
5 kg	20548	565.00 TL
6 kg		680.00 TL



Balyoz Sapı 20545 72.00 TL



Orak No:2

Ahşap Saplı

255.00 TL



Tahra

No:1 Küçük 225.00 TL

No:2 Büyük 245.00 TL

Tırpan Tahra

53 cm 245.00 TL



Tırpan Kasa Saplı

65 cm

1128.00 TL



Saçlı İnşaat Makarası

70/1	308.00 TL
100/1	393.00 TL
120/1	510.00 TL



Faryap Küreği Plastik

No:6 95.00 TL

Plastik Kar Küreği 150.00 TL

Plastik Zahire Küreği 120.00 TL



İnşaat Küreği

125.00 TL

Yapar İnşaat Küreği

4160 310.00 TL

Kürek Sapı

110.00 TL



Bel Küreği Ekonomik

Sivri 140.00 TL

Bel Küreği Sivri 245.00 TL



Gelberi Metal Sac

Plastik Gelberi 80.00 TL

55.00 TL



Kar Küreği - Dozer

125.00 TL



No:6 Faryap Saplı

310.00 TL

Zahire Küreği

Metal Saplı 565.00 TL



Çöp Küreği Saplı

50.00 TL

Soba Küreği

50.00 TL



Dirgen 3'lü

Dirgen 5'li 7.75 \$

Dirgen Sapı 335.00 TL

110.00 TL



Dövme Çelik Kollu Makaslar

Ø8 mm	22909	1584.- TL
Ø10 mm - 3.8 kg	22910	1620.- TL
Ø12 mm - 5.2 kg	22920	1890.- TL
Ø14 mm - 7.9 kg	22930	2295.- TL
Ø16 mm - 9.6 kg	22940	2565.- TL



Yedek Kesici Ağızlar

Ø10 mm - 1.2 kg	22950	1015.- TL
Ø12 mm - 1.9 kg	22955	1160.- TL
Ø14 mm - 2.6 kg	22960	1255.- TL
Ø16 mm - 3.4 kg	22970	1365.- TL



Oturak Makasları

Ø22 mm - 22.5 kg	5 295.- TL
Ø26 mm - 36.6 kg	7 600.- TL



Portatif Oturak Makaslar

Ø18 mm - 19.4 kg	6 500.- TL
------------------	------------



Yedek Kesici Ağızlar (Oturak Makasları)

Ø18 mm - 1.2 kg	567.- TL
Ø22 mm - 1.9 kg	650.- TL
Ø26 mm - 2.6 kg	750.- TL



Zincirli Boru Anahtarı

4"	7250.- TL
6"	12135.- TL



Çivi Önlüğü

Branda	51.- TL
--------	---------



Deri Çivi Önlüğü

	95.- TL
--	---------



Demir Bükme Köşebentli

350x220 mm, 5.17 kg	1620.- TL
---------------------	-----------



Rulmanlı Etriye Kolu

10E - Ø10 mm	1350.- TL
12E - Ø12 mm	1485.- TL



Basit Etriye Kolu

10EB - Ø10 mm	555.- TL
12EB - Ø12 mm	690.- TL



Dövme Çelik Demir Bükme Anahtarı

Ø10 mm - 0.9 kg	350.00 TL
Ø12 mm - 1.8 kg	472.00 TL
Ø14 mm - 1.95 kg	505.50 TL
Ø16 mm - 2.05 kg	640.00 TL
Ø18 mm - 3.05 kg	745.00 TL
Ø20 mm - 3.35 kg	810.00 TL
Ø22 mm - 5.35 kg	1080.00 TL
Ø24 mm - 5.65 kg	1150.00 TL
Ø26 mm - 6.00 kg	1215.00 TL

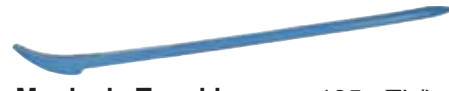

Manivela Topuklu

120-130-140-150-160 cm boyarında, kg ile satılır.	135.- TL/kg
---	-------------



Manivela Küskü

120-130-140-150-160 cm boyarında, kg ile satılır.	135.- TL/kg
---	-------------

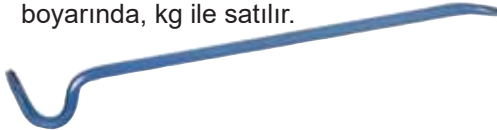

Sökü Demiri

100-110-120-130-140-150-160 -170cm boyarında, kg ile satılır.	135.- TL/kg
---	-------------



Çelik Şakül

500 gr	315.00 TL/Adet
--------	----------------



Kalıp Kilidi Çeşitleri

Perde kolon, kiriş kalıplarının karşılıklı tespitinde saplama yerine demir çubuk kullanılması halinde; Çubuğun iki ucuna takılarak kalıbın açılmasına mani olur. Yaıllı, tırtıllı çelik mandalı sayesinde demir çubuğu emniyetle sıkarak tutar.

Çiroz 3 mm	42.- TL
Çiroz 4 mm	45.- TL



Kollu Çiroz Makinası 1565.- TL

perde, kolon ve kiriş kapıların karşılıklı tespitinde kullanılan çiroz kilidini sıkarak içindir.



Tie - Rot Mili

1 m	10 adet/bağ
-----	-------------



Galvaniz Ayna, 4 mm



Tie - rot Somunu



İskele Keleçesi Tijli 146.00 TL

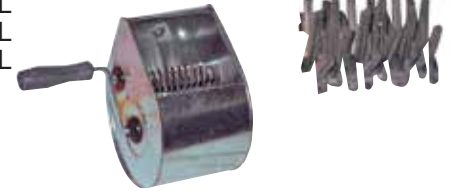

Sıva Serpme Makinası

Çelikli	1500.00 TL
Lastikli	1650.00 TL

Sıva Serpme Makinası Yedekleri

Yedek Lastik Çelikli	785.00 TL
Yedek Lastik Lastikli	850.00 TL



Tutkal Sürme Makinası 2300.00 TL

Yedek Rulo 700.00 TL
El ile istenilen miktarda tutkalı manuel olarak yüzeye uygular, rullo genişliği 15 cm'dir



Kablosuz Kapı Zili
DMX4649

6.15 \$



Eko Cam Menfez
ÖZS-8841

0.64 \$



Dijital Multimetre DT830D
DMX4646

5.70 \$



Fonksiyonlu Dijital
Multimetre A830L
DMX4647

9.75 \$



Dijital Termometre
Isı ve Nem Ölçer
DMX4653

6.95 \$



Analog Termometre
Isı ve Nem Ölçer
DMX4652

6.60 \$



Tırnak Makası 2'li Set
ÖZS-10431

1.25 \$



Saatçi Tornavida Seti 16 Parça
ÖZS-10477

3.95 \$



Fıfık Kıracağı
ÖZS-1921

1.90 \$



Ceviz Kıracağı
ÖZS-1923

2.25 \$



Plastik Maket Bıçağı
ÖZS-8889
50 Adet/Paket

0.32 \$



Asma Kilit Şifreli 40 mm
DMX4196

2.48 \$

Asma Kilit Şifreli 50 mm
DMX4197

3.16 \$



Yassı Eğe 8''
Saplı Blister Ambalajda
DMX4157

2.76 \$



Üçgen Eğe 8''
Saplı Blister Ambalajda
DMX4158

2.76 \$



Yuvarlak Eğe 8''
Saplı Blister Ambalajda
DMX4159

2.57 \$



Tamirci Cımbız Seti
7 Parça
DMX4658

4.90 \$



Döner Ahşap Törpü Seti
5 Parça
DMX4139

3.55 \$



Elmas Kalıpcı Freze Seti
5 Parça
DMX4138

6.95 \$



BAYTEC Şişe Kriko

2 ton	MK0450	18.60 \$
3 ton	MK0452	23.00 \$
5 ton	MK0454	28.00 \$
10 ton	MK0456	37.30 \$



MEŞEM Şişe Kriko

2 ton	MES 7560	27.50 \$
3 ton	MES 7561	34.24 \$
5 ton	MES 7562	43.00 \$
8 ton	MES 7563	55.00 \$
10 ton	MES 7564	57.50 \$
12 ton	MES 7565	65.00 \$
16 ton	MES 7566	72.00 \$
20 ton	MES 7567	90.00 \$
25 ton	MES 7568	95.00 \$
32 ton	MES 7569	109.00 \$



Şişe Kriko

2 Ton	34710	27.50 \$
3 Ton	34720	33.00 \$
5 Ton	34730	39.00 \$
10 Ton	34740	54.00 \$
15 Ton	34750	72.00 \$
20 Ton	34760	90.00 \$
30 Ton	34770	109.00 \$
50 Ton	34780	145.00 \$



Arabalı Garaj Kriko

2 ton	MK0470	48.70 \$
-------	--------	----------

Arabalı Garaj Kriko

3 ton, düşük şase	MK0476	240.- \$
-------------------	--------	----------



Cırcır Kollu Kriko

1.5 ton	MK0480	24.60 \$
---------	--------	----------



Tevsiyeci Çekiç

100 gr	20110	47.00 TL
200 gr	20120	67.00 TL
300 gr	20130	80.00 TL
500 gr	20140	105.00 TL
1000 gr	20150	190.00 TL
1500 gr	20160	234.00 TL
2000 gr	20170	290.00 TL



Çekiç Sapları

100 gr	20210	18.00 TL
200 gr	20220	19.00 TL
300 gr	20230	21.00 TL
500 gr	20240	23.00 TL
1000 gr	20250	26.00 TL
1500 gr	20260	28.00 TL
2000 gr	20270	30.00 TL



Keser Sapı	20720	19.00 TL
Saplı Keser Vakumlu		110.00 TL



Keser Askısı

Demir		22.00 TL
Keser Halkası		
Ekonomik EKH 001		15.00 TL



Kablo Kesme Makası

18x450 mm	MES 1420	18.05 \$
24x600 mm	MES 1421	25.70 \$
32x800 mm	MES 1422	41.00 \$
36x900 mm	MES 1423	41.80 \$



Demir Kesme Makası

14x350 mm	MES 4475	15.00 \$
18x450 mm	MES 4476	19.00 \$



BHD Ağaç Saplı Balta

500 gr		7.80 \$
600 gr		8.00 \$



BHD Fiber Saplı Balta

500 gr		8.00 \$
600 gr		8.25 \$



Alçıpan Testere

150 mm	MK4600	4.40 \$
--------	--------	---------



Pala Testere

500 mm	MK4605	4.80 \$
--------	--------	---------



Gazbeton Testere

500 mm	MK4610	13.70 \$
--------	--------	----------



Pala Testere Profesyonel

500 mm	MES 1880	6.30 \$
--------	----------	---------



PVC Boru Makası

42 mm	MK0690	8.60 \$
-------	--------	---------



PVC Boru Kesme Makası

42 mm	MK0695	11.10 \$
-------	--------	----------



PVC Boru Makası GRİ

42 mm	MK0685	5.40 \$
-------	--------	---------



PVC Boru Kesme Makası

42 mm	MES 502	7.50 \$
-------	---------	---------



Demir Kesme Makası

14x350 mm	MK4330	13.50 \$
18x450 mm	MK4331	16.40 \$
24x600 mm	MK4332	23.00 \$

Sıvacı Malası, Kartal Mala Ağaç Saplı

18 cm	598	127.00 TL
20 cm	600	130.00 TL
22 cm	602	135.00 TL
24 cm	604	140.00 TL
26 cm	606	145.00 TL



Kesik Malası

14 cm	618	127.00 TL
16 cm	620	130.00 TL
18 cm	624	135.00 TL
20 cm	626	140.00 TL



Dil Malası

18 cm	608	135.00 TL
-------	-----	-----------



Şap Malası

55 cm	637	190.00 TL
-------	-----	-----------



Seramik Mala, Kare Dış Plastik Saplı

40 cm, 8x8	008	179.00 TL
50 cm, 8x8	009	203.00 TL
30 cm, 6x6 Açık sap	012	135.00 TL
35 cm, 6x6 Açık sap	013	148.00 TL



Mantolama Malası

35 cm	080	148.00 TL
-------	-----	-----------



Alçı Malası, Açık Plastik Sap

30 cm	055	135.00 TL
35 cm	056	148.00 TL



Alçı Malası, Kapalı Plastik Sap

40 cm	051	178.00 TL
50 cm	052	203.00 TL



Marley Malası

80 cm	085	135.00 TL
-------	-----	-----------

Fayans Tarağı

Kare dış, 8x8, 22 cm	034	80.00 TL
----------------------	-----	----------

Eğri Saplı Spatula

20 cm	840	100.00 TL
25 cm	841	107.00 TL
30 cm	842	115.00 TL



Macun Spatula, Ağaç Saplı, Profesyonel

6 cm	800	84.00 TL
8 cm	801	89.00 TL
10 cm	802	94.00 TL
12 cm	803	99.00 TL
14 cm	804	102.00 TL
16 cm	805	107.00 TL
18 cm	806	112.00 TL



Sırık Spatula, Plastik Saplı

6 cm	807	48.00 TL
8 cm	808	52.00 TL
10 cm	809	55.00 TL
12 cm	810	60.00 TL
14 cm	811	64.00 TL
16 cm	812	68.00 TL
18 cm	813	72.00 TL



Mermer Malası

30 cm Açık sap	025	135.00 TL
40 cm Kapalı sap	020	178.00 TL
50 cm Kapalı sap	021	203.00 TL



Macun Küreği, Plastik Sap

16 cm	830	119.00 TL
18 cm	831	128.00 TL
20 cm	832	138.00 TL



Sıvacı Küreği Eko

44x35 cm	639	166.00 TL
----------	-----	-----------



Rulo Eleği

28x26 cm	900	33.00 TL
----------	-----	----------



Kauçuk Mala

28x14 cm	058	197.00 TL
----------	-----	-----------

Sünger Mala

17x25 cm	635	160.00 TL
----------	-----	-----------



Tırıl Mala Poliüretan

Kısa, 22x15 cm	630	123.00 TL
Uzun, 37x10 cm	631	132.00 TL



Plastik Derz Malası

Orta, 28x11 cm	045	135.00 TL
Uzun, 38x11 cm	046	154.00 TL



El Testeresi

12 cm	701 (700)	123.00 TL
14 cm	702 (703)	130.00 TL



Bağ Testeresi Ahşap Sap

12 cm	707	105.00 TL
-------	-----	-----------



Pala Testeresi

50 cm	708	191.00 TL
-------	-----	-----------



Gazbeton Testeresi

50 cm	710	179.00 TL
-------	-----	-----------



Kitan Usta Keseri

600 gr	680	320.00 TL
--------	-----	-----------



Zımpara Takoğu

Oynar Başlı	911	105.00 TL
-------------	-----	-----------



Kaleterasit Malası

29x15 cm	641	74.00 TL
----------	-----	----------

Sıva Serpme Küreği

21x20 cm	645	49.00 TL
----------	-----	----------



Çelik Şerit Metre

2 mt x 13 mm	MK4132	1.32 \$
3 mt x 16 mm	MK4133	1.62 \$
5 mt x 19 mm	MK4134	3.40 \$
5 mt x 25 mm	MK4135	3.62 \$
7 mt x 25 mm	MK4136	4.94 \$
10 mt x 25 mm	MK4137	6.00 \$



Krom Çelik Şerit Metre

3 mt x 16 mm	MK4145	1.97 \$
5 mt x 19 mm	MK4146	3.44 \$
5 mt x 25 mm	MK4147	3.84 \$
7 mt x 25 mm	MK4148	5.68 \$
10 mt x 25 mm	MK4149	7.13 \$



Şeffaf Çelik Şerit Metre

3 mt x 16 mm	MK4139	1.77 \$
5 mt x 19 mm	MK4140	2.92 \$
5 mt x 25 mm	MK4141	3.67 \$
8 mt x 25 mm	MK4142	5.38 \$
10 mt x 25 mm	MK4143	6.60 \$



MEŞEM Çelik Şerit Metre

3x16 mm	150	2.13 \$
5x19 mm	151	3.00 \$
5x25 mm	152	3.60 \$



Profesyonel Çelik Şerit Metre

5 mt x 25 mm	MK4152	4.17 \$
--------------	--------	---------



Çelik Şerit Metre

3 mt x 16 mm	26337	2.40 \$
5 mt x 19 mm	81606	3.76 \$
5 mt x 25 mm	26338	4.65 \$
10 mt x 25 mm	26341	8.30 \$



Fisco Şerit Metre

3 mt	197.00 TL
5 mt	283.00 TL



Mastarlı Su Terazisi

40 mm	MK0665	4.60 \$
50 mm	MK0664	5.10 \$
60 mm	MK0666	5.60 \$
80 mm	MK0669	6.50 \$
100 mm	MK0670	7.80 \$



Mıknatıslı Su Terazisi

40 mm	MK0600	6.30 \$
50 mm	MK0610	6.90 \$
60 mm	MK0620	7.50 \$
80 mm	MK0640	8.90 \$
100 mm	MK0642	11.00 \$



Turkeystar Su Terazisi

40 mm	MK0582	7.30 \$
50 mm	MK0583	8.50 \$
60 mm	MK0584	8.80 \$
80 mm	MK0586	10.20 \$
100 mm	MK0588	12.20 \$



Turkeystar Mıknatıslı Su Terazisi

40 mm	MK0590	7.90 \$
50 mm	MK0591	9.00 \$
60 mm	MK0592	19.90 \$
80 mm	MK0594	11.80 \$
100 mm	MK0596	13.80 \$



Mıknatıslı Mini Su Terazisi

23 cm	MK0680	0.96 \$
-------	--------	---------



Hassas Terazi

2 kg x 0.1 gr

Dijital El Kantarı

3.85 \$



Elektronik Terazi

37.80 \$



Arazi Şerit Metre

20 mt x 12.5 mm	MK4160	11.95 \$
30 mt x 12.5 mm	MK4161	17.20 \$
50 mt x 12.5 mm	MK4162	22.63 \$



Cam Vantuzu Plastik

2'li	MK4509-2	7.50 \$
3'lü	MK4509-4	12.50 \$



Cam Vantuzu Alüminyum

2'li	MK4509-6	10.30 \$
3'lü	MK4509-8	18.20 \$



Kablo Sıyırma Pensesi

MES 4370

10.87 \$



Kablo Sıyırma Pensesi Plus

MES 4371

17.40 \$



Yedek Maket Bıçağı

0.5x18 mm MK1560

0.835 \$



Bıçak Bileme

1.85 \$



Kemer Delme Makinası

MK1268

4.65 \$



Mesafe Ölçer

LM 40 - menzil 40 m	47.50 \$
LM 50 - menzil 50 m	55.38 \$
LM 60 - menzil 60 m	63.28 \$
LM 80 - menzil 80 m	75.70 \$
LM 100 - menzil 100 m	90.50 \$
LM 120 - menzil 120 m	156.00 \$
LM 150 - menzil 150 m	195.00 \$



UT 243
Güç ve Harmonik Pensampermetre



UT 387 B Duvar Tarayıcı
Dijital Metal Dedektörü 88.00 \$



UT 200 A Dijital Pens Ampermetre
AC 200 Amper 38.00 \$

UT 201 AC Dijital Pens Ampermetre
AC 400 Amper 48.00 \$



UT 230 B
Priz Ampermetre 45.00 \$



UT 383 B Mini Işık Ölçer 36.00 \$

UT 353 Dijital Ses Ölçer 34.00 \$



UT 377 A Ağaç Nem Ölçer 42.00 \$

UT 373 Mini Takometre 40.00 \$



UT 202 AC/DC Dijital Pens Ampermetre
ve Isı Ölçer 52.00 \$
AC 400 /600 Amper -40C +750C

UT 203 AC/DC Dijital Pens Ampermetre
AC DC 400 Amper 93.00 \$



UT 123
Cep Tipi Multimetre 26.00 \$



UT 120C Cep Tipi Multimetre
AC DC 400 42.00 \$

UT 120 A Cep Tipi Multimetre
AC 600 34.00 \$



UT 363 S Dijital Anemometre
Rüzgar Ölçer 66.00 \$

UT 333
Mini Sıcaklık Nem Ölçer 37.00 \$



UT 206 A Dijital Pens Ampermetre
AC 1000 Amper 132.00 \$



UT 33 B
Dijital Multimetre 22.00 \$

DT 830 B
Dijital Multimetre 8.00 \$



UT 300 S İnfrared Termometre
-32° - 400° 39.00 \$



BK1-1402-2011 Monofaze
1x16 A. Düz Fiş 72.00 TL
Ambalaj: 30 Adet



BK1-1402-2311 Monofaze
1x16 A. Uzatma Fiş 105.30 TL
Ambalaj: 25 Adet



BK1-1402-3511 Monofaze
1x16 A. Duvar Priz 127.80 TL
Ambalaj: 12 Adet



BK1-1402-3612 Monofaze
1x16 A. İkili Grup 214.50 TL
Ambalaj: 8 Adet



BK1-1402-3613 Monofaze
1x16 A. Üçlü Grup 240.30 TL
Ambalaj: 7 Adet

BK1-1402-3614 Monofaze
1x16 A. Dörtlü Grup 287.20 TL
Ambalaj: 8 Adet



BK1-1402-2022 Monofaze
1x16 A. Eğik Fiş 85.20 TL
Ambalaj: 20 Adet



BY8-1402-2700
BEM 10-011 Monofaze
1x16 A. Pano Priz 81.60 TL
Ambalaj: 30 Adet



BY8-1402-2720
BEM 10-012 Monofaze
1x16 A. UPS Pano Priz 106.60 TL
Ambalaj: 30 Adet



BP1-1402-2410
BEM 10-022 Monofaze
1x16 A. Makina Priz 103.10 TL
Ambalaj: 18 Adet

BP1-1402-2510
BEM 10-023 Monofaze
1x16 A. Duvar Priz 162.10 TL
Ambalaj: 6 Adet



BP1-1402-3510
BEM 10-240 Monofaze
Duvar Kasalı Pano Priz 142.00 TL
Ambalaj: 12 Adet



BP1-2504-4012
BY10 -302 Trifaze
3x25 A. Düz Fiş 101.90 TL
Ambalaj: 20 Adet



BP2-2504-4415
BY10 - 314 Trifaze
3x25 A. Makine Priz 140.60 TL
Ambalaj: 18 Adet

BP2-2504-4416
BY10 - 317 Trifaze
3x25 A. Duvar Priz 158.20 TL
Ambalaj: 6 Adet



BK1-2504-4011
BY10 - 300 Trifaze
3x25 A. Düz Fiş 105.50 TL
Ambalaj: 20 Adet



BK1-2504-4023
BY10 - 304 Trifaze
3x25 A. Eğik Fiş 140.60 TL
Ambalaj: 16 Adet



BK6-2504-4511
BY10 - 305 Trifaze
3x25 A. Duvar Priz 193.30 TL
Ambalaj: 14 Adet



BK1-2504-4314
BY10 - 301 Trifaze
3x25 A. Uzatma Priz 158.20 TL
Ambalaj: 15 Adet



BK6-2504-4612
BY10 - 306 Trifaze
3x25 A. İkili Grup Priz 369.00 TL
Ambalaj: 5 Adet

BK6-2504-4613 BY10 310
3x25 A. Üçlü Grup Priz 439.20 TL
Trifaze + monofaze
Ambalaj: 6 Adet

BK6-2504-4615
BY10 - 308 Trifaze
3x25 A. Üçlü Grup Priz 474.40 TL
Ambalaj: 6 Adet



BK6-2504-4611
BY10 - 307
3x25 A. +1x16 A. İkili Grup Priz 351.40 TL
Trifaze + Monofaze
Ambalaj: 5 Adet

BK6-2504-4614
BY10 - 309
3x25 A.2 +2x16A. Üçlü Grup Priz 456.80 TL
Trifaze + Monofaze
Ambalaj: 6 Adet



BA1-1001-0001 (BEM 58-300)
Seyyar EI Lambası 473.60 TL
Ambalaj: 12 Adet

BA1-1001-1031 (BEM 58-301)
Seyyar EI Lambası 438.90 TL
(Anahtarsız)
Ambalaj: 12 Adet

BA1-1001-1031 (BEM 58-302)
Seyyar EI Lambası 875.90 TL
(Anahtarlı + Kablolu)
Ambalaj: 6 Adet

BA1-2001-1031 (BEM 58-303)
Seyyar EI Lambası 825.40 TL
(Anahtarsız+ Kablolu)
Ambalaj: 6 Adet

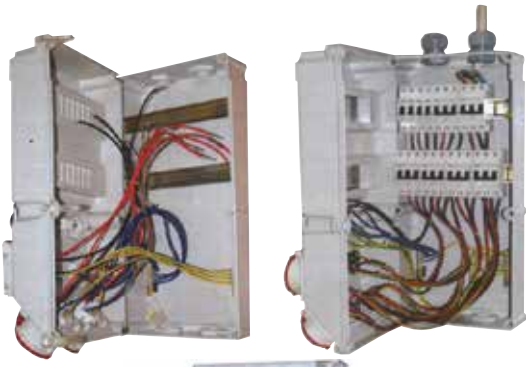

BK6-1504-2011
BY10 - 200 174.00 TL
3x16 A. Düz Fiş
Ambalaj: 28 Adet

BK6-3504-2011
BY10 - 205 210.90 TL
3x32 A. Düz Fiş
Ambalaj: 18 Adet

BC1-1303-2011
BEM 30-025 186.50 TL
3x16 A. 110 V Düz Fiş
Ambalaj: 10 Adet

BC1-1303-2312
BEM 30-027 263.60 TL
3x16 A. 110 V Uzatma Priz
Ambalaj: 10 Adet



BK6-1504-2311
BY10 - 201 210.90 TL
3x16 A. Düz Fiş
Ambalaj: 20 Adet

BK6-3504-2311
BY10 - 206 263.60 TL
3x32 A. Düz Fiş
Ambalaj: 12 Adet

BC1-1403-2011
BEM 35-025 162.60 TL
3x16 A. 110 V Düz Fiş
Ambalaj: 10 Adet

BC1-1403-2312
BEM 35-027 213.10 TL
3x16 A. 110 V Uzatma Priz
Ambalaj: 10 Adet

BY1-1504-2011
BY10 - 218 164.20 TL
16x25 A. Yassı Düz Fiş
Ambalaj: 15 Adet

BY1-2504-2011
BY10 - 221 301.10 TL
25x40 A. Yassı Düz Fiş
Ambalaj: 15 Adet

BY1-4504-2011
BY10 - 224 455.40 TL
50x63 A. Yassı Düz Fiş
Ambalaj: 8 Adet

BY1-1504-2511
BY10 - 220 216.30 TL
16x25 A. Yassı Duvar Priz
Ambalaj: 12 Adet

BY1-2504-2511
BY10 - 223 355.80 TL
25x40 A. Yassı Duvar Priz
Ambalaj: 7 Adet

BY1-4504-2511
BY10 - 225 492.60 TL
40x63 A. Yassı Duvar Priz
Ambalaj: 4 Adet

BY1-1504-2311
BY10 - 219 216.30 TL
16x25 A. Yassı Uzatma Priz
Ambalaj: 15 Adet

BY1-2504-2311
BY10 - 222 355.80 TL
25x40 A. Yassı Uzatma Priz
Ambalaj: 8 Adet

BK6-1504-2022
BY10 - 203 184.50 TL
3x16 A. Eğik Fiş
Ambalaj: 20 Adet

BK6-1504-2511
BY10 - 204 210.90 TL
3x16 A. Duvar Fiş
Ambalaj: 18 Adet

BK6-3504-2511
BY10 - 209 263.60 TL
3x32 A. Duvar Fiş
Ambalaj: 10 Adet

BC1-4504-7413
BEM 40-616 1181.10 TL
4x63 A. Makine Priz Pilotlu
Su geçirmez
Ambalaj: 1 Adet

BC1-1403-2420
BEM 35-028 199.70 TL
3x16 A. 45°Eğik Makine Priz
Ambalaj: 6 Adet

BC1-1403-2510
BEM 35-030 294.90 TL
3x16 A. Makine Priz
Ambalaj: 6 Adet

BC1-4504-7312
BEM 40-615 1521.80 TL
4x63 A. Uzatma Priz Pilotlu
Ambalaj: 1 Adet



BC1-1505-2235
BEM 45-050 294.25 TL
5x16 A. Eğik Duvar Priz
Ambalaj: 3 Adet



BC1-1505-2413
BEM 45-046 179.20 TL
5x16 A. Makine Priz (75x75)
Ambalaj: 15 Adet



BC1-1505-2510
BEM 45-048 244.20 TL
5x16 A. Duvar Priz
Ambalaj: 6 Adet



BC1-3505-2312
BEM 45-087 232.40 TL
5x32 A. Uzatma Priz
Ambalaj: 8 Adet



BC1-3505-2420
BEM 45-088 222.40 TL
5x32 A. Eğik Makine Priz
Ambalaj: 8 Adet



BC1-3505-7011
BEM 45-540 256.95 TL
5x32 A. Düz Fiş
Ambalaj: 3 Adet



BC1-3505-7420
BEM 45-545 297.45 TL
5x32 A. Eğik Makine Priz
Ambalaj: 3 Adet



BC1-1505-2011
BEM 45-042 142.35 TL
5x16 A. Düz Fiş
Ambalaj: 8 Adet

BC1-3504-2011
BEM 45-042 164.70 TL
4x32 A. Düz Fiş
Ambalaj: 8 Adet

BC1-3505-2011
BEM 45-083 189.40 TL
5x32 A. Düz Fiş
Ambalaj: 8 Adet



BC1-1505-2312
BEM 45-045 187.85 TL
5x16 A. Uzatma Priz
Ambalaj: 8 Adet

BC1-3504-2312
BEM 40-077 216.00 TL
4x32 A. Uzatma Priz
Ambalaj: 8 Adet



BC1-3505-7312
BEM 45-5439 319.25 TL
5x32 A. Uzatma Priz
Ambalaj: 4 Adet



BC1-4504-7011
BEM 40-614 637.20 TL
4x63 A. Düz Fiş,
Su geçirmez
Ambalaj: 1 Adet

BC1-6504-7011
BEM 40-7011 2 039.15 TL
4x125 A. Düz Fiş,
Su geçirmez
Ambalaj: 1 Adet



BC1-6504-7312
BEM 40-702 2 082.40 TL
4x125 A. Uzatma Priz
Ambalaj: 1 Adet



BY10-202
3x16 A. Makine Priz 137.60 TL
Ambalaj: 10 Adet



BY10-102
1/16A Kauçuk Dişi Fiş 50.75 TL

BY10-100
1/16A Kauçuk Erkek Fiş 28.50 TL



BY10-104
1/16A 2'li Monofaze 112.90 TL
Kablouz Grup Priz

BY10-105
1/16A 3'lü Monofaze 95.12 TL
Kablouz Grup Priz

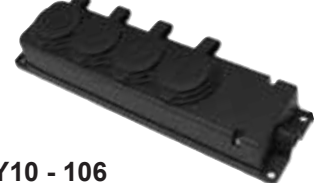

BY10-106
1/16A 4'lü Monofaze 132.50 TL
Kablouz Grup Priz



BEM 80-252
Topraklama
Genişlik 315 mm, Yükseklik 430 mm,
Ağırlık 27.6 Kg, 25 mm Kablo Kesiti,
20 mt Kablo Boyu

BEM 80-290
Topraklama
Genişlik 360 mm, Yükseklik 400 mm,
Ağırlık 20-30 Kg, 25 mm Kablo Kesiti,
15 mt Kablo Boyu

BEM 80-291
Topraklama
Genişlik 390 mm, Yükseklik 490 mm,
Ağırlık 35-45 Kg, 25 mm Kablo Kesiti,
20 mt kablo boyu

BEM 81-294
Topraklama Tambur
Genişlik 265 mm, Yükseklik 470 mm,
Ağırlık 30 Kg, 20 mt Sarım



Erkek Fiş Kırılmaz 21.00 TL
Ambalaj Adedi : 500
07110



Dişi Fiş Kırılmaz 21.00 TL
Ambalaj Adedi : 500
07111



L Tipi Topraklı Erkek Fiş 32.60 TL
Ambalaj Adedi : 500
07118



Ara Puar Anahtarı 21.00 TL
(Bakalit)
Ambalaj Adedi : 500
07113



Topraklı Erkek Fiş 28.50 TL
Ambalaj Adedi : 300
07115



Topraklı Erkek Fiş 31.80 TL
(Kulplu)
Ambalaj Adedi : 300
07116



Topraklı Dilşi Fiş 32.50 TL
(Kırılmaz- Klemensli)
Ambalaj Adedi : 300
07117



Fişli Grup Golyat 82.50 TL
Ambalaj Adedi : 20
07301



Golyat Papatya 82.50 TL
Golyat Sıva Altı Priz 109.00 TL



Golyat Priz 5'li 26.50 TL
3'lü T Fiş 26.50 TL



3'Lü Grup Priz (Topraklı-Klemensli) 90.00 TL
Ambalaj Adedi :24
07302



3'Lü Grup Priz (Topraklı-Anahtarlı) 146.00 TL
Ambalaj Adedi :24
07307



3'Lü Grup Priz (Topraklı-Kordonlu)
2 metre 07303 230.00 TL
3 metre 07304 271.00 TL
5 metre 07305 357.00 TL
Ambalaj Adedi :20



3'Lü Grup Priz
(Topraklı-Kordonlu-Anahtarlı)
2 metre 07310 285.00 TL
3 metre 07311 325.00 TL
5 metre 07312 412.00 TL
Ambalaj Adedi :12



4'Lü Grup Priz (Topraklı) 120.00 TL
Ambalaj Adedi :24
07401

4'Lü Grup Priz (Topraklı-Anahtarlı) 172.00 TL
Ambalaj Adedi :24
07406



4'Lü Grup Priz (Topraklı-Kordonlu)
2 metre 07402 257.00 TL
3 metre 07403 300.00 TL
5 metre 07404 400.00 TL
Ambalaj Adedi :12



4'Lü Grup Priz
(Topraklı-Kordonlu-Anahtarlı)
2 metre 07407 318.00 TL
3 metre 07408 360.00 TL
5 metre 07409 455.00 TL
Ambalaj Adedi :12



6'Lü Grup Priz (Topraklı) 175.00 TL
Ambalaj Adedi :24
07601



6'Lü Grup Priz (Topraklı-Anahtarlı) 227.00 TL
Ambalaj Adedi :24
07606



6'Lü Grup Priz (Topraklı-Kordonlu)
2 metre 07602 315.00 TL
3 metre 07603 360.00 TL
5 metre 07604 450.00 TL
Ambalaj Adedi :12



6'Lü Grup Priz
(Topraklı-Kordonlu-Anahtarlı)
2 metre 07607 370.00 TL
3 metre 07608 415.00 TL
5 metre 07609 508.00 TL
Ambalaj Adedi :12

**Siyah TTR Kablolar
H05VV-F
PVC izoleli, çok damarlı,
bükülgen bakır iletkenli kablolar**

2 x 0.75 mm	13.20 TL/ mt
2 x 1. mm	16.65 TL/ mt
2 x 1.5 mm	22.70 TL/ mt
3 x 0.75 mm	18.30 TL/ mt
3 x 1 mm	22.55 TL/ mt
3 x 1.5 mm	31.30 TL/ mt
3 x 2.5 mm	50.00 TL/ mt
4 x 1 mm	29.40 TL/ mt
4 x 1.5 mm	40.60 TL/ mt
4 x 2.5 mm	65.25 TL/ mt
4 x 4 mm	102.00 TL/ mt
4 x 6 mm	149.00 TL/ mt

**Beyaz TTR Kablolar - H05VV-F
PVC izoleli, çok damarlı,
bükülgen bakır iletkenli kablolar**

2 x 1.5 mm	24.00 TL/ mt
3 x 1 mm	24.00 TL/ mt
3 x 1.5 mm	33.10 TL/ mt
3 x 2.5 mm	53.00 TL/ mt
4 x 1 mm	31.00 TL/ mt
4 x 1.5 mm	43.00 TL/ mt
4 x 2.5 mm	69.00 TL/ mt



Ara Kablolar

20 mt, 3x1.5 mm	36910	545.00 TL
35 mt, 3x1.5 mm	36930	760.00 TL
50 mt, 3x1.5 mm	36931	965.00 TL
20 mt, 3x2.5 mm		695.00 TL
30 mt, 3x2.5 mm		885.00 TL
40 mt, 3x2.5 mm		1125.00 TL

Ara Kablo Boş Makara 275.00 TL

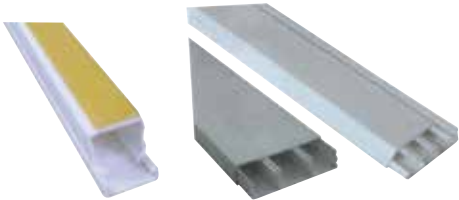

Kablo Kanalları Yapışkanlı

2 metrelik boylarda satılır.

12 x 12 mm (220 mt/bağ)	10.85 TL/ mt
16 x 16 mm (144 mt/bağ)	13.07 TL/ mt
25 x 16 mm (80 mt/bağ)	20.05 TL/ mt
25 x 25 mm (98 mt/bağ)	26.25 TL/ mt
40 x 25 mm (80 mt/bağ)	37.30 TL/ mt



2200-401, Anahtar
Beyaz 78.00 TL
Renkli 115.00 TL

5962-102, Light
Beyaz 82.00 TL
Renkli 119.00 TL



5962-103, Kapı Otomatığı 82.00 TL



5962-104, Zil Anahtarı
Beyaz 82.00 TL
Renkli 119.00 TL



5962-105, Vavien
Beyaz 99.00 TL
Renkli 141.00 TL



5962-106, Komitatör
Beyaz 99.00 TL
Renkli 141.00 TL



**HS-4200 Mekanik
Zaman Ayarlı Priz** 205.00 TL



**3'lü Monofaze
10 mt Kablolü
Grup Priz**



2200-100, Topraklı Priz
Beyaz 92.00 TL
Renkli 130.00 TL



**2200-105, Rita Kapaklı
Topraklı Priz**
Beyaz 97.00 TL
Renkli 136.00 TL

Rita 2'li Topraklı Priz
Beyaz 125.00 TL
Renkli 208.00 TL



5962-113, Telefon Priz
Beyaz 94.00 TL
Renkli 135.00 TL



5962-119, Tv Priz Geçişli
Beyaz 120.00 TL
Renkli 203.00 TL



5962-122, Uydu Priz 176.00 TL



Sıva Üstü Priz 72.00 TL
Sıva Üstü Priz 2'li 110.00 TL



Sıva Üstü Anahtar 68.00 TL
Sıva Üstü Anahtar 2'li 81.00 TL



Şerit Led 3 Çip Şerit
İçmekan, 750 lümen/m, 14/4 W/1m
Beyaz Işık, CT-4480 22.50 TL/mt
Güneşiği, CT-4481 22.50 TL/mt



Şerit LED Trafosu Slim
5 Amper - 60 W 140.00 TL
12.5 Amper - 150 W 240.00 TL
3 Amper - 36 W 110.00 TL
10 Amper - 120 W 200.00 TL



Eklenebilir Şerit Led Süsleme Işığı
CT-8500, 10 mt, Flaşlı
Beyaz Işık, 210.00 TL
Güneşiği 210.00 TL



Ledli Yatay Bant Armatür
18 W-6400 Kelvin, Beyaz 3.90 \$
60x7.5 cm,
40 W-6400 Kelvin, Beyaz 4.50 \$
120x7.5 cm



Sıva Altı Led Panel
6 W-6500 Kelvin 6.10 \$
9 W-4" -6500 Kelvin 8.10 \$
12 W-6400 Kelvin 9.40 \$
15 W-6" -6500 Kelvin 10.60 \$



Sıva Üstü Kare Led Panel
18 W-6400 Kelvin 170.00 TL
21x2.8 cm,
24 W-6400 Kelvin 260.00 TL
22x3.6 cm



Sensörlü Tavan Armatürü 290.00 TL



LED Projektörü Sensörlü
CT-4620, 10 W 525.00 TL



LED Projektörü Sensörlü
CT-4652, 20 W 700.00 TL

LED Projektörü Sensörlü
CT-4653, 30 W 1000.00 TL



Helios LED Projektörü
200 W, 6500K 1885.00 TL



Helios LED Projektörü
51-5010, 30 W 265.00 TL

Helios LED Projektörü
51-5010, 50 W 300.00 TL

Helios LED Projektörü
HS-3816, 100 W 715.00 TL

Helios LED Projektörü
HS-3817, 150 W 1235.00 TL



Radar Sensörü
CT-9185 285.00 TL



Sıva Altı Hareket Sensörü
CT-9242, 360 derece 215.00 TL



Sıva Altı Hareket Sensörü
CT-9240, 180 derece 245.00 TL



Sıva Altı Hareket Sensörü
CT-9243, 360 derece 245.00 TL



CATA Led Kapsül Ampül
CT-4255, (G4) 47.00 TL
3W , 12 V, 195 lümen



CATA Led Kapsül Ampül
CT-4256, (G9) 47.00 TL
2W , 220 V, 95 lümen



CATA Led Kapsül Ampül
CT-4221, (G9) 57.00 TL
5W , 220 V, 190 lümen

CATA Led Kapsül Ampül
CT-4222, (G9) 80.00 TL
4W , 220 V, 190 lümen



CATA Çanak Led Ampül
CT-4215 42.00 TL
7W , 220 V, 480 lümen, G10 duylu



CATA Şarjlı Işıldak
CT-9932, 30 Led, 3W 370.00 TL
CT-9960, 60 Led, 6W 525.00 TL
CT-9990, 90 Led, 9W 775.00 TL

**Armut Ampul**

40-60-75-100 watt

LED Ampul

9 W, Sarı Beyaz Işık

25.00 TL

LED Ampul

15 W, Sarı Beyaz Işık

49.00 TL

LED Ampul

18 W,

75.00 TL

**CATA Rustik Led Ampul****CT-4284, E27**

95.00 TL

6W, 540 lümen, uzun filament

CATA Rustik Gold Led Ampul**CT-4351, E27**

160.00 TL

4W, 300 lümen

**Helios Rustik Led Kıvrık Ampul****43-4001, E14**

60.00 TL

4W, 360 lümen

**CATA Led Ampul****CT-4277 Renkli, E27**

46.00 TL

9W, 140 lümen, Kırmızı, Yeşil, Mavi

**CATA Led Düz Buji Ampul****CT-4066, E14**

48.00 TL

4W, 400 lümen

**CATA Rustik Led Düz Ampul****CT-4283, E27**

60.00 TL

4W, 310 lümen, amber renk
2700 K elvin**CATA RGB Led Ampul****Uzaktan Kumandalı**

137.00 TL

CT-4058, E27

9W, 80 lümen

**CATA Led Düz Buji Ampul****CT-4076, E14**

37.00 TL

5W, 420 lümen

CATA Led Düz Buji Ampul**CT-4079, E14**

38.00 TL

7W, 680 lümen

CATA Led Düz Buji Ampul**CT-4083, E14**

41.00 TL

8W, 720 lümen

**CATA Led Kıvrık Buji Ampul (Amber)****CT-4281, E14**

55.00 TL

4W

CATA Rustik Led Ampul**CT-4288, E27**

60.00 TL

4W

**CATA Edison Led Ampul****CT-4232, E27**

30.00 TL

6W, 500 lümen, beyaz

CATA Led Buji Ampul**CT-4091, E27**

55.00 TL

8W, 800 lümen, beyaz

**CATA Led Kıvrık Buji Ampul****CT-4062, E14**

51.00 TL

4W, 410 lümen

CATA Led Kıvrık Buji Ampul**CT-4077, E14**

37.00 TL

5W, 410 lümen

CATA Led Kıvrık Buji Ampul**CT-4080, E14**

40.00 TL

7W, 680 lümen

**CATA Rustik Led Ampul****CT-4313, E27**

135.00 TL

6W, 450 lümen

CATA Rustik Led Ampul (Amber)**CT-4298, E27**

80.00 TL

4W

**CATA Glop Led Ampul****CT-4234, E27**

142.00 TL

12W, 1220 lümen, beyaz

CATA Glop Led Ampul**CT-4235, E27**

150.00 TL

15W, 1500 lümen, beyaz

CATA Glop Led Ampul**CT-4236, E27**

225.00 TL

20W, 1650 lümen, beyaz

**CATA Alevli Led Ampul****CT-4059, E27**

175.00 TL

5W, 190 lümen, 3 fonksiyonlu

**Helios Rustik Led Ampul****43-4006, E27**

120.00 TL

4W, 360 lümen

Helios Rustik Led Ampul**43-4007, E27**

221.00 TL

6W, 540 lümen

**Torch Led Ampul****CT-4263, E27**

3.15 \$

35W, 2200 lümen

Torch Led Ampul**CT-4242, E27**

4.35 \$

45W, 3700 lümen

Torch Led Ampul**CT-4262, E27**

5.15 \$

55W, 4300 lümen

Bakalit Asma Duy 18.00 TL

Priz Duy 20.00 TL

Bakalit Asma Duy Saplı 29.00 TL

W Otomat
W Otomat 2A 4.70 \$
W Otomat 6A 3.50 \$
W Otomat 10A 3.50 \$
W Otomat 16A 3.50 \$
W Otomat 20A 3.50 \$
W Otomat 25A 3.50 \$
W Otomat 32A 4.25 \$
W Otomat 40A 4.60 \$

Buat Siyah Geçmeli derin kasa kapaksız 3.00 TL

Buat Turuncu Geçmeli derin kasa kapaksız 5.65 TL

Alçıpan Buatı 12.35 TL

Lüks Buat Kapağı 3.75 TL

Lüks Buat Kapağı Büyük 120 çap 9.75 TL

Kare Buat Kapağı 15x15 25.00 TL

Kare Buat Kapağı 20x20 35.00 TL

Florasın Zinciri 14.50 TL/mt

Floresan Ampul
18/54 W 50.00 TL
36/54 W 55.00 TL

Çubuk Halojen Ampul
5983 - 126, 500 watt 50.00 TL
5983 - 129, 1000 watt 60.00 TL

Soket Tipli Enerji Tasarruflu Ampul
5980-112 70.00 TL
18 Watt, 6400K, G24
Koli Adedi :100

5980-122 70.00 TL
10 Watt, 6400K, G24
Koli Adedi :100

5980-142 70.00 TL
13 Watt, 6400K, G24
Koli Adedi :100

5980-143 70.00 TL
26 Watt, 6400K, G24
Koli Adedi :100

Starter 59106 17.00 TL

Uydu Anten Kablosu 15.00 TL/mt

Uydu Soketi 12.00 TL
Uydu Ara Konnektör 12.00 TL

Cat6 İnternet Kablosu 15.00 TL

RJ45 İnternet Jaki 7.50 TL

İnternet Ara Konnektör 37.- TL

Elektrik Kablosu 2x0.75 mm 15.00 TL/ mt

Dekoratif Tavan Armatürü 95.00 TL

Kablo Rakoru (Polyamid Malzemeden)

PG 7 - 3-6 mm 9.60 TL
PG 9 - 4-8 mm 11.30 TL
PG 11 - 5-10 mm 12.80 TL
PG 13.5 - 6-12 mm 14.00 TL
PG 16 - 10-14 mm 17.60 TL

PG 21 - 33-18 mm 24.30 TL
PG 29 - 18-25 mm 38.70 TL
PG 36 - 22-32 mm 75.60 TL
PG 42 - 32-38 mm 93.10 TL
PG 48 - 38-44 mm 107.00 TL

Elektrikli Sustası Plastik

10 mt 105.00 TL
15 mt 160.00 TL
20 mt 210.00 TL
25 mt 265.00 TL

Kablo Toplama Spirali 22 mm 3.28 \$/mt

Kablosuz Kapı Zili 240.- TL

Kablosuz Kapı Zili 3 Sesli Kanarya 108.- TL

Kablosuz Kapı Zili 3 Sesli DING DONG 108.- TL

PT 8200 Kablosuz Kapı Zili 280.- TL

23 farklı zil sesi, blister ambalaj, ses ünitesi 2xAA pil ile çalışır, zil butonu 7x23A pil ile çalışır, 23A pil ürüne dahildir, AA piller ürüne dahil değildir.



GYU Kablo Pabucu

GYU 401 (0.5-1.5)	200 Adet/paket	1.32 TL
GYU 501 (0.5-1.5)	200 Adet/paket	1.34 TL
GYU 601 (0.5-1.5)	200 Adet/paket	2.10 TL
GYU 402 (1.5-2.5)	200 Adet/paket	1.62 TL
GYU 502 (1.5-2.5)	200 Adet/pake	1.00 TL
GYU 602 (0.5-1.5)	200 Adet/paket	2.34 TL
GYU 606 (2.5-6)	100 Adet/paket	3.41 TL
GYU 1006 (0.5-1.5)	250 Adet/paket	3.84 TL
GYU 802 (1.5-2.5)	200 Adet/paket	2.34 TL



SKN 1-03 İzolesiz

500 adet/paket 1.175 TL/Adet

Fosfor Tip Terminal

TSF - 1 D 6.3 1.175 TL/Adet

300 adet/paket



IYF İzoleli Yüksük

IYF 0.50	1000 Adet/paket	0.281 TL
IYF 0.75	1000 Adet/paket	0.281 TL
IYF 1	1000 Adet/paket	0.281 TL
IYF 1.50	1000 Adet/paket	0.305 TL
IYF 2.50	500 Adet/pake	0.391 TL
IYF 4	500 Adet/paket	0.660 TL
IYF 6	250 Adet/paket	0.875 TL
IYF 10	100 Adet/paket	1.106 TL



Lehim Telleri

30/70 - 500gr, 1.6 mm	26990	30.00 \$
40/60 - 500gr, 1.6 mm	26991	35.00 \$
60/40 - 500gr, 1.2 mm	26992	46.00 \$
30/70 - 200gr, 1.6 mm	26994	12.15 \$
40/60 - 200gr, 1.6 mm	26995	14.00 \$
60/40 - 200gr, 1.2 mm	26996	19.00 \$



Lehim Telleri

40/60 - 50gr	MES 4141	2.00 \$
40/60 - 100gr	MES 4142	3.77 \$

Lehim Telleri

40/60 - 50gr	MK 0424	1.55 \$
--------------	---------	---------

Pastalı Lehim Havya Seti

40/60	MES 4140	2.42 \$
-------	----------	---------

Pastalı Lehim Havya Seti

60/40	MK 0422	1.95 \$
-------	---------	---------



Soldex Malı Lehim Pastalar

40 gr		1.45 \$
50 gr	27000	4.50 \$
250 gr	27002	16.20 \$



Kabo Bağı

(100 Adetlik torba fiyatı)

100 x 2.5 mm	1801	14.50 TL
150 x 2.5 mm	11802	21.00 TL
200 x 2.5 mm	11803	31.00 TL
150 x 3.5 mm	11804	31.50 TL
200 x 3.5 mm	11805	51.00 TL
250 x 3.5 mm	11806	59.20 TL
300 x 3.5 mm	11807	75.50 TL
200 x 4.8 mm	11808	69.00 TL
250 x 4.8 mm	11809	85.00 TL
300 x 4.8 mm	11810	99.60 TL
380 x 4.8 mm	11811	125.00 TL
400 x 4.8 mm		140.00 TL
450 x 4.8 mm	11817	160.00 TL
500 x 4.8 mm	11819	170.00 TL
300 x 8.0 mm	11818	210.00 TL
380 x 8.0 mm	11814	245.00 TL
450 x 8.0 mm	11815	285.00 TL
550 x 8.0 mm	11816	372.00 TL
600 x 8.0 mm	11798	550.00 TL
760 x 7.6 mm		505.00 TL
760 x 9.0 mm	11800	690.00 TL



Data Jak Pensesi

35.00 \$



Kablo Sıyırma Pensesi

175 mm. 21835 41.00 \$



Eltos Takviye Maşası

Mini	MTM311	22.00 TL
Orta	MTM310	26.00 TL
Büyük	TM310	36.00 TL



Eltos Edoni

Tüp Lehim ETL001 64.00 TL

Eltos Edoni ELP002 55.00 TL

Lehimleme Pastası



Eltos Toolux TLP005 130.00 TL

Lehim Pompası



Eltos KHA 006 178.00 TL

Kelon Havya Altlığı



Sıra Klemens

No: 1 - 2.5-4mm ²	23.15 TL
No: 2 - 4-6mm ²	25.00 TL
No: 3 - 6-10mm ²	32.00 TL
No: 4 - 10-16mm ²	41.00 TL
No: 5 - 16-25mm ²	48.50 TL



Antigrön Çivili Kroşe

No: 0 - 0.75 (yassı kordon için)	0.20 TL
No: 1 - 0.75 (yassı kordon için)	0.20 TL
No: 2 - 0.75 (yassı kordon için)	0.20 TL
No: 3 - 2x1.5 3x1.5	0.35 TL
No: 4 - 2x4	0.35 TL
No: 5 - 2x4 4x4	0.45 TL
No: 6 - 4x6	0.45 TL



Yapışkan Kroşe

19x19 mm 1.35 TL/Adet
28x28 mm 2.40 TL/Adet



Yapışkanlı Kablo Klipsi

13x16 mm 1.70 TL/Adet
25x25 mm 2.55 TL/Adet



Kablo Bağı Dübeli

8x43 mm 100 Adet/paket 140.- TL/Adet
10x45 mm 100 Adet/paket 150.- TL/Adet



Zeytin Klemens

Mavi	1.20 TL
Sarı	1.20 TL
Yeşil	1.20 TL
Siyah	1.20 TL
Kırmızı	1.20 TL
Kahverengi	1.20 TL



Porselen Klemens (Isıya Dayanıklı)

No : 1	16.00 TL
No : 2	20.00 TL
No : 3	29.00 TL
No : 4	35.00 TL
No : 5	45.60 TL



Banyo WC Aspiratörü Fanexfan MF-FAN

100 mm, 15 watt, 95 m ³ /s	11.- \$
120 mm, 20 watt, 185 m ³ /s	12.- \$
150 mm, 35 watt, 285 m ³ /s	17.- \$
200 mm, 40 watt, 360 m ³ /s	32.- \$



Banyo WC Aspiratörü Yuvarlak (D-DTY)

150 mm, 35 watt, 285 m ³ /s	37017	25.- \$
--	-------	---------



Yağ Tutucu Filtre (FYTF)

315 mm, 72 watt, 330 m ³ /s	57072	35.- \$
--	-------	---------



Monofaze Hız Anahtarı (PHA)

PHA - 01, 100 watt-1100 watt	57035	45.- \$
------------------------------	-------	---------



Çatı Fanları Yatay Atışlı

FCF 315, 145 watt, 1650 m ³ /s	57131	255.- \$
---	-------	----------



Dıştan Rotorlu Boru Kanal Tip Aspiratör (DRPKT)

200 mm, 90 watt, 850 m ³ /s	57049	71.- \$
250 mm, 120 watt, 1800 m ³ /s	57050	82.- \$
300 mm, 160 watt, 2500 m ³ /s	57051	95.- \$



Yuvarlak Kanlı Tipi Radyal Fanlar (LKT-B)

100 mm, 72 watt, 255 m ³ /s	57061	61.- \$
125 mm, 72 watt, 330 m ³ /s	57062	67.- \$
160 mm, 120 watt, 715 m ³ /s	57063	75.- \$
200 mm, 160 watt, 990 m ³ /s	57064	106.- \$
250 mm, 195 watt, 1250 m ³ /s	57065	116.- \$
315 mm, 310 watt, 1875 m ³ /s	57066	140.- \$
355 mm, 420 watt, 2200 m ³ /s	57067	300.- \$



Toz Emici Körukler (FAGS)

0.37 kw, 1250 m ³ /s, 200 mm/ss, 380 volt	57135	650.- \$
0.75 kw, 2100 m ³ /s, 240 mm/ss, 380 volt	57136	757.- \$
1.5 kw, 3050 m ³ /s, 300 mm/ss, 380 volt	57137	1100.- \$
2.2 kw, 3550 m ³ /s, 350 mm/ss, 380 volt	57138	1500.- \$
3 kw, 4000 m ³ /s, 380 mm/ss, 380 volt	57139	1700.- \$
0.37 kw, 1250 m ³ /s, 200 mm/ss, 220 volt	57140	700.- \$
0.75 kw, 2100 m ³ /s, 240 mm/ss, 220 volt	57141	900.- \$
1.50 kw, 3100 m ³ /s, 300 mm/ss, 220 volt	57142	1180.- \$
2.2 kw, 3550 m ³ /s, 350 mm/ss, 220 volt	57143	1600.- \$



Panjur Menfez

30x30 mm	140.00 TL
35x35 mm	155.00 TL
35x45 mm	175.00 TL
35x55 mm	215.00 TL
40x40 mm	175.00 TL
40x50 mm	205.00 TL
45x45 mm	215.00 TL
45x55 mm	240.00 TL
50x50 mm	275.00 TL
55x65 mm	315.00 TL
60x60 mm	380.00 TL



Doğalgaz Cam Menfezi

30.00 TL



Doğalgaz Cam Menfezi Ayarlı

62.00 TL



Dönerli Baca Kapağı

20.00 TL



Ayarlı Panjur Baca Kapağı

90.00 TL



Kombi Baca Contası

30.00 TL



Duvar Tipi Baca Aspiratör (PEK)

20 cm, 40 watt, 220V, 340 m ³ /h	37182	58.- \$
25 cm, 40 watt, 220V, 668 m ³ /h	37183	65.- \$
30 cm, 50 watt, 220V, 1145 m ³ /h	37184	72.- \$
35 cm, 65 watt, 220V, 1900 m ³ /h	37185	80.- \$



Küçük Motorlu Monofaze Sanayi Aspiratörleri (PSM)

25 cm, 120 watt, 220V	37202	120.- \$
30 cm, 130 watt, 220V	37203	132.- \$
35 cm, 155 watt, 220V	37204	136.- \$
40 cm, 185 watt, 220V	37205	150.- \$
45 cm, 210 watt, 220V	37206	165.- \$
50 cm, 225 watt, 220V	37207	175.- \$
60 cm, 560 watt, 220V	37208	210.- \$

Küçük Motorlu Trifaze Sanayi Aspiratörleri (PST)

25 cm, 120 watt, 220V		120.- \$
30 cm, 130 watt, 220V	37211	132.- \$
35 cm, 155 watt, 220V	37212	136.- \$
40 cm, 185 watt, 220V	37213	150.- \$
45 cm, 210 watt, 220V	37214	165.- \$
50 cm, 225 watt, 220V	37215	175.- \$
60 cm, 560 watt, 220V	37216	210.- \$



Metal Gövdeli Dıştan Rotorlu Fanlar

DRTOS, 140-60, 150 watt, 500 m ³ /s	57084	80.- \$
DRBTMS, 140-60, 165 watt, 580 m ³ /s	57085	90.- \$
DRBTMS, 180-70, 320 watt, 900 m ³ /s	57087	125.- \$



Metal Gövdeli Obra Seri Radyal Fan

POBRA 180-70	57093	175.- \$
--------------	-------	----------



AC Aksiyel Kapaklı Aspiratörler (PKA-KA Sessiz)

16 cm, 35 watt, 220V, 250 m ³ /h	37033	51.- \$
20 cm, 40 watt, 220V, 600 m ³ /h	37034	57.- \$
25 cm, 50 watt, 220V, 800 m ³ /h	37035	72.- \$

AC Aksiyel Kapasız Aspiratörler (PKA-AK Sessiz)

16 cm, 35 watt, 220V, 350 m ³ /h	57029	48.- \$
20 cm, 40 watt, 220V, 600 m ³ /h	57030	52.- \$
25 cm, 50 watt, 220V, 800 m ³ /h	57031	58.- \$



Kanal Tip Aksiyel Fan, Plastik, Sessiz (APKT)

100 mm, 15 watt, 95 m ³ /h	37022	16.- \$
120 mm, 20 watt, 190 m ³ /h	37023	17.- \$
150 mm, 25 watt, 305 m ³ /h	37024	22.- \$
200 mm, 35 watt, 370 m ³ /h	37025	33.- \$



Metal Gövdeli Radyal Fanlar

BTMS 140-60, 140 watt, 520 m ³ /h	57079	90.- \$
--	-------	---------



Sık Kanatlı 3000 Devir Salyangoz Aspiratörler

FAGS-M2, 0.37 kw, 220V, 1650 m ³ /h	57124	570.- \$
FAGS-T2, 0.37 kw, 380V, 1700 m ³ /h	57125	470.- \$

Alüminyum Gövdeli Salyangoz Aspiratörler

BAGS, 140-60, 220V, 180 watt, 540 m ³ /h		88.- \$
---	--	---------

Eko Seri Aynalı ve Rozetli Kollar



Aynalı Bravo

Sac Ayna, Alüminyum Kol	
Oda	120.00 TL
Yale	120.00 TL
WC	135.00 TL

Rozetli Bravo

Alüminyum Rozet, Alüminyum Kol	
Oda	155.00 TL
Yale	155.00 TL
WC	175.00 TL



Aynalı Avşa

Sac Ayna, Alüminyum Kol	
Oda	90027 250.00 TL
Yale	90028 250.00 TL
WC	90029 275.00 TL

Rozetli Avşa

Alüminyum Rozet, Alüminyum Kol	
Oda	90131 305.00 TL
Yale	90132 305.00 TL
WC	90133 330.00 TL



Aynalı Safir

Sac Ayna, Alüminyum Kol	
Oda	90009 320.00 TL
Yale	90010 320.00 TL
WC	90011 350.00 TL

Rozetli Safir

Alüminyum Rozet, Alüminyum Kol	
Oda	90131 425.00 TL
Yale	90132 425.00 TL
WC	90133 455.00 TL

Lux Seri Aynalı ve Rozetli Kollar



Aynalı Kuğu

Sac Ayna, Alüminyum Kol	
Oda	90036 320.00 TL
Yale	90037 320.00 TL
WC	90038 350.00 TL

Rozetli Kuğu

Alüminyum Rozet, Alüminyum Kol	
Oda	90221 425.00 TL
Yale	90222 425.00 TL
WC	90223 455.00 TL



Barel Mert Marka

68 mm Mert Marka	267.00 TL
76 mm Mert Marka	300.00 TL
80 mm Mert Marka	300.00 TL
83 mm Mert Marka	300.00 TL
90 mm Mert Marka	325.00 TL
100 mm Mert Marka	365.00 TL

Bilyalı Barel

68 mm	310.00 TL
-------	-----------

Barel İthal

83 mm Alüminyum	200.00 TL
90 mm Alüminyum	200.00 TL



Topuzlu Barel

68 mm Nikel	310.00 TL
-------------	-----------



Kilit Sürgü

No : 1 - 38x120 mm	47.00 TL
No : 2 - 38x140 mm	54.00 TL
No : 3 - 38x160 mm	57.00 TL
No : 4 - 38x180 mm	62.00 TL



Kuyruklu Mentеше

No : 3	23.00 TL
No : 4	25.00 TL
No : 5	26.75 TL
No : 6	31.00 TL
No : 7	34.00 TL



Tirajlı Kilit (Karşılıksız)	340.00 TL
14 mm	
Tirajlı Kilit Karşılığı	27.00 TL



150R Mert Rulmanlı Silindirik Kilit	
35 mm Sarı	90500 450.- TL
35 mm Saten	450.- TL



151R Mert Rulmanlı Oda Kilit	
35 mm Sarı	29011 190.00 TL
35 mm Saten	190.00 TL
45 mm Siyah	195.00 TL



153B Mert Rulmanlı Banyo-WC Kilit	
35 mm Sarı	90503 190.00 TL
35 mm Saten	190.00 TL

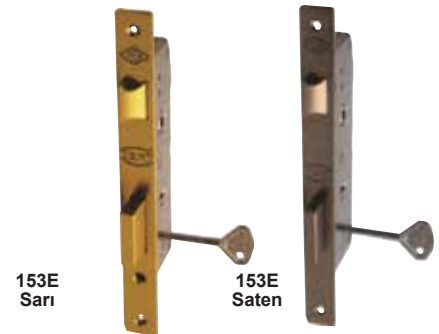

153E Mert Gömme Oda Kilit	
40 mm Sarı	90502 150.00 TL
40 mm Saten	150.00 TL



Şifreli Asma Kilit

21 mm	MK2420	2.684 \$
28 mm	MK2421	5.125 \$
38 mm	MK2376	2.100 \$
50 mm	MK2377	2.700 \$



Kapı Hidroliği

No: 3	MK2320	17.10 \$
No: 4	MK2320-2	23.30 \$
No: 5	MK2320-4	34.80 \$



Asma Kilit Sarı (Eko)

25 mm	MK2342	0.590 \$
32 mm	MK2343	0.809 \$
38 mm	MK2344	0.950 \$
50 mm	MK2345	1.500 \$
63 mm	MK2346	2.200 \$



Yassı Kilit

60 mm	MK2456	4.56 \$
70 mm	MK2457	5.14 \$
80 mm	MK2458	5.69 \$
90 mm	MK2459	5.79 \$

MEŞEM Otomatik Kapı Hidroliği

No: 3	45-65 kg	4410	20.00 \$
No: 4	65-80 kg	4411	27.00 \$



Yassı Çelik Kilit

60 mm	MES 360	6.75 \$
70 mm	MES 361	7.50 \$
80 mm	MES 362	8.17 \$
90 mm	MES 363	8.92 \$



Asma Kilit Uzun Sarı (Eko)

32 mm	MK2350	0.900 \$
38 mm	MK2351	1.067 \$
50 mm	MK2352	1.650 \$
63 mm	MK2353	2.360 \$



Çelik Asma Kilit Çivili

38 mm	MK2437	1.942 \$
50 mm	MK2438	2.750 \$
63 mm	MK2439	3.830 \$

Asma Kilit (Gri Döküm)

20 mm	MK2321	0.46 \$
25 mm	MK2322	0.54 \$
32 mm	MK2323	0.80 \$
38 mm	MK2324	0.98 \$
50 mm	MK2325	1.59 \$
63 mm	MK2326	2.31 \$



Asma Kilit Uzun (Gri Döküm)

25 mm	MK2326-1	0.580 \$
32 mm	MK2327	0.850 \$
38 mm	MK2328	1.110 \$
50 mm	MK2329	1.750 \$
63 mm	MK2330	2.525 \$



Çelik Asma Kilit

30 mm	MK2426	1.25 \$
40 mm	MK2427	1.85 \$
50 mm	MK2428	2.34 \$
60 mm	MK2429	2.92 \$
70 mm	MK2430	3.68 \$



Asma Kilit (Sarı)

20 mm	MK2331	0.62 \$
25 mm	MK2332	0.67 \$
32 mm	MK2333	0.89 \$
38 mm	MK2334	1.10 \$
50 mm	MK2335	1.77 \$
63 mm	MK2336	2.42 \$
75 mm	MK2336-1	2.80 \$



Master Çelik Asma Kilit

55 mm 3'lü set	MK2440	10.30 \$
55 mm 4'lü set	MK2441	13.70 \$
55 mm 5'li set	MK2442	17.12 \$
55 mm 6'lı set	MK2443	20.60 \$
55 mm 8'li set	MK2444	27.40 \$



Çelik Asma Kilit Uzun

30 mm	MK2431	1.34 \$
40 mm	MK2432	1.90 \$
50 mm	MK2433	2.53 \$
60 mm	MK2434	3.14 \$
70 mm	MK2435	3.96 \$

Asma Kilit Uzun (Sarı)

25 mm	MK2336-2	0.84 \$
32 mm	MK2337	1.00 \$
38 mm	MK2338	1.20 \$
50 mm	MK2339	1.85 \$
63 mm	MK2340	2.65 \$
75 mm	MK2341	4.49 \$



Pirinç Asma Kilit

32 mm	MK2390	2.609 \$
38 mm	MK2391	3.559 \$
50 mm	MK2392	5.675 \$
63 mm	MK2393	9.209 \$



Lüks Raf Altı Konsol

140x110 mm - 5x6	23.25 TL
200x135 mm - 6x8	30.65 TL
230x165 mm - 7x9	33.81 TL
260x190 mm - 8x10	38.50 TL
290x230 mm - 10x12	42.10 TL
330x260 mm - 12x14	56.60 TL



Burgulu Raf Altı Konsol

1501502	95.00 TL
150x150 mm	
2002002	118.00 TL
200x200 mm	
2002502	125.00 TL
200x250 mm	
2003002	131.00 TL
200x300 mm	



Ferforje Raf Altı Konsol

1201503 siyah 35930	95.00 TL
120x150 mm	
1602003 siyah 35931	105.00 TL
160x200 mm	
1902503 siyah 35932	120.00 TL
190x250 mm	
2203003 siyah 35933	136.00 TL
220x300 mm	



Zig Zag Raf Altı Konsol - 510

2002002	
200x200 mm 35940	101.00 TL
2502502	
250x250 mm 35941	106.00 TL



Ayarlı Raf Altı Konsol

No:1 180x112 mm	114.50 TL
No:2 250x150 mm	124.00 TL
No:3 290x160 mm	129.00 TL



Emniyet Mandalı

EMN 04 - Beyaz Kilitli	55.00 TL
EMN 04 - A.Kahve Kilitli	61.00 TL
EMN 04 - Koyu Kahve Kilitli	61.00 TL

Koli Adedi: 50



Plastik Pencere Kolu Demirli

Beyaz	01879	30.00 TL
-------	-------	----------



Plastik Yaylı Kapı Kolu

Yale	98.00 TL
WC	105.00 TL

Alüminyum Yaylı Kapı Kolu

Yale	190.00 TL
WC	200.00 TL



Zamak Kapı Mentеше, 100 mm EKO

ZM 017 - Beyaz	33.00 TL
ZM 017 - Açık Kahve	39.00 TL
ZM 017 - Koyu Kahve	39.00 TL

Zamak Pencere Mentеше, 75 mm EKO

ZM 009 - Beyaz	25.85 TL
ZM 009 - Açık Kahve	29.55 TL
ZM 009 - Koyu Kahve	29.55 TL



Halatlı Emniyet Kiliti

80.00 TL



Topuzlu Otel Kiliti

360.- TL
360.- TL



Cam Kapı Kilit Aparatı

295.- TL

Çelik Rozetli Çekme Kol

Inox kaplama

16 cm	31016	215.00 TL
27 cm	31021	258.00 TL



Eko Yer Tamponu

01669 24.00 TL



Kapı Kolu Tamponu

20.00 TL

5 adet/pk



Kapı Tamponu

01695 30.00 TL



Kapı Tokmağı Kumru

110.00 TL

Saten

Kapı Tokmağı Mevlana

110.00 TL

Siyah



Çelik Kapı Emniyet Kelepçesi

200.00 TL



Panik Kilit

475.- TL

İş güvenlik önlemleri için işletmelerde acil çıkış kapılarına takılma mecburu-riyeti olan kapı kilitidir.



Erciyes Aynalı Kapı Kolu

Oda	425.- TL
Yale	425.- TL
WC	465.- TL

Erciyes Kare Rozetli Kapı Kolu

Oda	425.- TL
Yale	425.- TL
WC	465.- TL



Europa Aynalı Kapı Kolu

Oda	425.- TL
Yale	425.- TL
WC	465.- TL

Europa Kare Rozetli Kapı Kolu

Oda	425.- TL
Yale	425.- TL
WC	465.- TL



Lotus Aynalı Kapı Kolu

Oda	425.- TL
Yale	425.- TL
WC	465.- TL

Lotus Kare Rozetli Kapı Kolu

Oda	425.- TL
Yale	425.- TL
WC	465.- TL

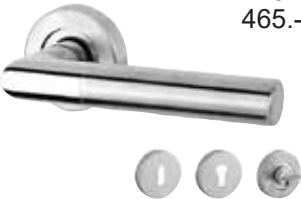

Zenker Sümer Paslanmaz Yuvarlak Rozetli Kapı Kolu

Oda	240.- TL
Yale	240.- TL
WC	240.- TL



Kristal Aynalı Kapı Kolu

Oda	425.- TL
Yale	425.- TL
WC	465.- TL

Kristal Kare Rozetli Kapı Kolu

Oda	425.- TL
Yale	425.- TL
WC	465.- TL

Kristal Aynalı Siyah Kapı Kolu

Oda	440.- TL
Yale	440.- TL
WC	480.- TL

Kristal Siyah Rozetli Kapı Kolu

Oda	440.- TL
Yale	440.- TL
WC	480.- TL



Eymen Porselen Rengi Kulp

128 mm	
Krom	41.00 TL
Antik Sarı	39.00 TL
Antik Bakır	39.00 TL
Mat Siyah	39.00 TL



Ovacık Çizgili Kulp - 167

128 mm	
Krom	32.00 TL
Mat Siyah	27.00 TL
Antik	44.00 TL
Altın Sarısı	35.00 TL

Ovacık Çizgili Kulp - 167

192 mm	
Krom	37.00 TL
Mat Siyah	32.00 TL
Antik	54.00 TL
Altın Sarısı	40.00 TL



Maymuncuk	
50 mm	15.00 TL
100 mm	18.00 TL
140 mm	28.00 TL



Akordion Oval Kirma Menteşesi	27.50 TL
-------------------------------	----------

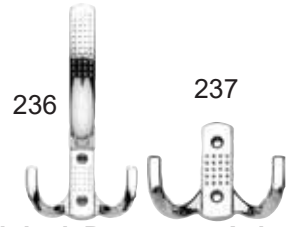

Klas Noktalı Portmanto Askı - 236

Krom	34.00 TL
Mat Siyah	34.00 TL

Klas Noktalı Portmanto Askı - 237

Krom	22.00 TL
Mat Siyah	22.00 TL



Bafra Sarkaç - 1132

Antik Bakır	42.00 TL
Antik Sarı	42.00 TL
Altın Sarı	42.00 TL
Mat Siyah	42.00 TL



Halka Sarkaç - X1015

Antik Sarı	30.50 TL
Antik Bakır	30.50 TL



Sekizgen Sarkaç - 686

Krom	30.25 TL
Antik Sarı	30.25 TL
Antik Bakır	30.25 TL
Mat Siyah	30.25 TL
Altın Sarı	30.25 TL



Eco Cordia - K211

Krom	28.90 TL
Antik Sarı	28.90 TL
Antik Bakır	28.90 TL

Ayna Düğme

Krom	26.00 TL
Antik Sarı	26.00 TL
Antik Bakır	26.00 TL
Antrasit	26.00 TL
Siyah	26.00 TL



Kristal Düğme

Krom	26.00 TL
Antik Sarı	26.00 TL
Antik Bakır	26.00 TL
Antrasit	26.00 TL
Siyah	26.00 TL



Alüminyum İçten Çıkmalı Mentеше
7.5 cm 65.00 TL/ Adet
10 cm 78.00 TL/ Adet
25 Adet/Paket



Kelebek Okka Mentеше
10 cm Saten 67.00 TL/ Adet



Kaynaklı Mentеше
60x40x2.5 mm 60.00 TL/ Adet
20 Adet/Paket



Alüminyum Yönsüz Mentеше
10 cm 41.00 TL/ Adet
12 cm 49.00 TL/ Adet
20 Adet/Paket



Çelik İçten Çıkmalı Mentеше
7.5 cm 42.00 TL/ Adet
(20 Adet/Paket)
10 cm 51.00 TL/ Adet
(20 Adet/Paket)

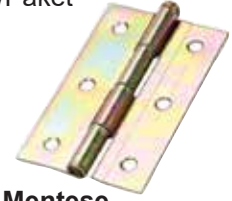

Yaprak Mentеше
No : 2 9.80 TL/ Adet
No : 2.5 11.50 TL/ Adet
No : 3 13.60 TL/ Adet
No : 3.5 20.30 TL/ Adet
No : 4 28.50 TL/ Adet



304 Paslanmaz Mentеше
4 cm - 40x40x1.5 mm
(25 Adet/Paket) 143.00 TL/ Adet
6 cm - 60x40x1.5 mm
(25 Adet/Paket) 175.00 TL/ Adet
8 cm - 80x60x1.5 mm
(25 Adet/Paket) 215.00 TL/ Adet



Çelik Universal Mentеше
10 cm 127.00 TL/ Adet
10 Adet/Paket



Ayarlı Pergola Ayak
25 Adet/Paket 110.00 TL/ Adet



Alüminyum Gömme Sürgü
9 cm 74.00 TL/ Adet
(25 Adet/Paket)
12 cm 84.00 TL/ Adet
(20 Adet/Paket)



Çelik Universal Mentеше
7.5 cm 71.00 TL/ Adet
20 Adet/Paket

Cerman Mentеше

No : 8 Sağ 22.00 TL/ Adet
No : 8 Sol 22.00 TL/ Adet
No : 10 Sağ 29.00 TL/ Adet
No : 10 Sol 29.00 TL/ Adet
No : 12 Sağ 33.00 TL/ Adet
No : 12 Sol 33.00 TL/ Adet
No : 14 Sağ 39.00 TL/ Adet
No : 14 Sol 39.00 TL/ Adet
24 Adet/Paket



Müller Mentеше

No : 10 Sağ 29.00 TL/ Adet
No : 10 Sol 29.00 TL/ Adet
No : 12 Sağ 33.00 TL/ Adet
No : 12 Sol 33.00 TL/ Adet
No : 14 Sağ 39.00 TL/ Adet
No : 14 Sol 39.00 TL/ Adet



Çelik Oval Mentеше
10 cm 127.00 TL/ Adet
10 Adet/Paket

Alüminyum Okka Mentеше

10 cm 172.00 TL/ Adet
(25 Adet/Paket)
12 cm 215.00 TL/ Adet
(15 Adet/Paket)

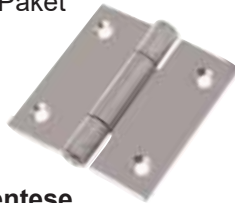

Kare Mentеше
60x60x2.5 mm 60.00 TL/ Adet
20 Adet/Paket



Sandık Askısı
25x62 10.00 TL/ Adet
30x88 14.50 TL/ Adet
35x115 17.65 TL/ Adet



Alüminyum Cumbalı Mentеше
2.5 mm
10 cm 62.00 TL/ Adet
12 cm 72.00 TL/ Adet



Çelik Okka Mentеше
10 cm 94.00 TL/ Adet
10 Adet/Paket



Sandık Kulbu
24 Adet/Paket 14.00 TL/ Adet



Mavzer Sürgü

No: 4	24.00 TL/Adet
No: 6	24.25 TL/Adet
No: 8	25.00 TL/Adet
No: 10	28.00 TL/Adet
No: 12	29.00 TL/Adet
12 Adet / Kutu	



Gömme Sürgü

12 Adet / Kutu	47.00 TL/Adet
----------------	---------------



Lüks Mandallı Gömme Sürgü	
16 cm	235.00 TL/Adet

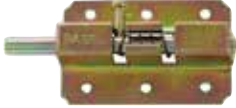

Yaylı Kapı Sürgüsü

68x45 mm	18.00 TL/Adet
----------	---------------



Demir Doğrama Sürgüsü

12 Adet / Kutu	34.00 TL/Adet
----------------	---------------



Geniş Düz Gönye

No: 1 - 30x70	11.00 TL/Adet
No: 2 - 30x90	12.75 TL/Adet
No: 3 - 30x110	16.50 TL/Adet

Düz Gönye

No: 1 - 16x40	4.00 TL/Adet
No: 2 - 16x80	5.00 TL/Adet
No: 3 - 15x90	5.60 TL/Adet
No: 4 - 15x110	6.30 TL/Adet
No: 5 - 15x130	7.70 TL/Adet



Köşe Gönye

No: 1 - 15x25	4.15 TL/Adet
No: 2 - 15x35	4.90 TL/Adet
No: 3 - 15x45	5.60 TL/Adet
No: 4 - 15x55	6.30 TL/Adet
No: 5 - 15x65	7.70 TL/Adet
No: 6 - 15x75	8.30 TL/Adet
No: 7 - 15x85	9.75 TL/Adet

Geniş Köşe Gönye

No: 1 - 30x30	8.40 TL/Adet
No: 2 - 30x40	9.80 TL/Adet
No: 3 - 30x50	11.90 TL/Adet



Oval Köşe Gönye

15x25x25	4.15 TL/Adet
23x30x30	4.50 TL/Adet



203-1 Asmalı Mandallı Kilit

Düz Dil	74.00 TL
---------	----------

207 Çelik Kollu Dolap Kiliti



311-1 Kelebek Yaylı Pano Kilidi

Krom Kaplama	79.00 TL
--------------	----------

312-1 Kelebek Yaylı Pano Kilidi

Plastik	40.00 TL
---------	----------

308-2 Yaylı Pano Kilidi Üçgen

Krom Kaplama	66.00 TL
--------------	----------



298-1 Silindirli Kelebek Kilit

Krom Kaplama	145.00 TL
--------------	-----------

298-2 Silindirli Kelebek Kilit

Plastik Kafa	145.00 TL
--------------	-----------



328-2 Yangın Dolap Kilidi

Plastik Krom Kaplama	132.00 TL
----------------------	-----------

371 Plastik Pano Mandalı

	45.00 TL
--	----------



Korniş Demiri

15x115x60 mm	8.75 TL/Adet
--------------	--------------



Masa Köşe Bağlantısı

100 Adet/Kutu	32.00 TL/Adet
---------------	---------------



366 Kaldır Çevir Kilit

	54.00 TL
--	----------

308-1 DB Yaylı Pano Kilidi

Krom Kaplama	66.00 TL
--------------	----------



324 Plastik Yaylı Pano Kilidi

Plastik Gövde	66.00 TL
---------------	----------

308-3 Yaylı Pano Kilidi Kare

	66.00 TL
--	----------



311-3

Kelebek Asma Mandallı Pano Kilidi

	75.00 TL
--	----------



201-1

Mandallı Anahtarlı Kilit

	116.00 TL
--	-----------



210 Kare Mobilya Kilidi

	53.00 TL
--	----------



Oval Çekmece Kilidi MK1750

	0.85 \$
--	---------

Kare Çekmece Kilidi MK1760

	0.82 \$
--	---------

Oval Çekmece Kilidi MES 3450

	1.166 \$
--	----------

Kare Çekmece Kilidi MES 3451

	1.000 \$
--	----------



Cam Kilidi

MK1790	
--------	--

	2.00 \$
--	---------



Baby Ayarlı Pencere Kilidi
4000901 37.00 TL



Baby Çok Amaçlı Kilit
4000909 33.75 TL



Led Yapıştırma Bandı
10 mm x 6 mt



Baby Raylı Dolap Kilidi
4000902 37.00 TL



Baby Mini Çok Amaçlı Kilit
4000910 38.70 TL



Pass Plaka Yapıştırma Bandı
95 mm x 30 mm



Baby Vidasız Köşe Kilidi
4000903 37.00 TL



Baby Figürlü Sünger Kapı Stoperi
4000912 37.00 TL



Baby Sünger Kapı Stoperi
4000904 32.00 TL



Baby Şeffaf Yuvarlak Köşe Koruyucu
35309 (4'lü set) 48.00 TL



Pass Çok Amaçlı Yapışkan Ped
12 mm x 12 mt



Baby Priz Koryucu Kapağı
4000905 (6'lı set) 32.00 TL



Baby Çocuk Güvenlik Dolap ve Çekmece Kilidi
35308 38.70 TL



Baby Kapak Kilidi
4000906 37.00 TL

Pass Plastik Yapışkan Askı
2'li
Büyük Boy



Baby Masa Köşe Koruyucu
4000907 (4'lü set) 40.00 TL



Pass Reflektif Bant
35 mm x 1.5 mt
Kırmızı
Sarı
Beyaz
Yeşil

Pass Kaydırmaz Band
Islak Zemin için
19 mm x 20 cm



Baby Dekoratif Masa Köşe Koruyucu
4000908 (4'lü set) 32.00 TL



Pass Fosforlu Bant Yeşil
35 mm x 1.5 mt

Pass 2'li Paslanmaz Askılık
Yapışkanlı



Pass Zemin Kaydırmaz Bant Siyah
25 mm x 5 mt
50 mm x 5 mt



Uzun Pres Musluk (Karlüks) 160.00 TL
Kısa Pres Musluk (Karlüks) 160.00 TL
Mix Musluk 245.00 TL



Çamaşır Musluk 160.00 TL



Çamaşır Ara Çatal Musluk 335.- TL



Çamaşır Musluk Çift Çıkışlı 235.- TL



Mini Küresel Çamaşır Musluk 120.- TL



Çamaşır Musluk Çatalı 80.00 TL



Taharet Musluk 105.00 TL



Taharet Musluk Paslanmaz 125.00 TL



Filtreli Taharet Musluk 105.00 TL



Taharet Musluk Kapaklı Takım 100.00 TL



Rakorlu Bahçe Musluk
1/2 160.00 TL
3/4 175.00 TL



Küresel Bas 200.- TL



Musluk Ucu Rakoru Metal Erkek 30.00 TL

Musluk Ucu Rakoru Metal Dişi 30.00 TL



Fiber Conta
3/8" 0.75 TL
1/2" 0.75 TL
3/4" 0.75 TL

Fiber Conta
3/8" - 100 Adet/Pk 37.00 TL
1/2" - 100 Adet/Pk 37.00 TL
3/4" - 100 Adet/Pk 37.00 TL



Musluk Contası
Adet 0.75 TL
100 Adet/Pk 37.00 TL



Lastik Conta
1/2" 0.75 TL
3/4" 0.75 TL

Lastik Conta
1/2" - 100 Adet/Pk 37.00 TL
3/4" - 100 Adet/Pk 37.00 TL



Musluk Rozeti 14.00 TL



Batarya Dirseği Deve Boynu 37.00 TL



Taç Volan 25.00 TL



1/2 Delikli Uzatma PVC Musluk Ucu 75.00 TL
20.00 TL



Ters Musluk Kılavuzu
Küçük M25-M35 3970 3.00 \$
Büyük M35 - M50 3971 4.00 \$



Eltos Musluk Raybası EMR014 150.00 TL



Salmastra (Musluk Göbeği) 53.00 TL



Salmastra (Aç-Kapa) 71.00 TL



Salmastra (Gömme Rezervuar için)
3.5 cm 150.00 TL
5 cm 175.00 TL



Keten 550.00 TL



50" Adaptör 3.50 TL



Helataşı Adaptör 11.00 TL



Kısa Kartuş
35 mm 75.00 TL
40 mm 75.00 TL



Oynar Perlatörlü Musluk Başlık 100.- TL



3 Fonksiyonlu MES 144 2.50 \$
Krom Kubar Başlık



Kireç Önleyici 100.00 TL



Roben Mix
Banyo Bataryası 735.- TL



Lina Mix Kısa Kuğu
Banyo Bataryası 765.- TL



Delta Mix
Banyo Bataryası 920.- TL



Roben Mix
Lavabo Bataryası 465.- TL



Lina Mix Kısa Kuğu
Lavabo Bataryası 555.- TL



Delta Mix
Lavabo Bataryası 645.- TL



Roben Mix
Evye Bataryası 465.- TL

Lina Mix Uzun Kuğu
Evye Bataryası 555.- TL



Acem Banyo Bataryası 915.- TL



Delta Mix
Evye Bataryası 645.- TL



Mix Batarya
Yedek Borusu 4.20 \$



Acem Evye Bataryası 545.- TL

Delta Mix
Oynar Perlatör 715.- TL



Mix Batarya Kolu
35'lik 65.00 TL
40'lik 72.00 TL



Su Arıtma Musluğu 275.- TL



Altan Tekli Mix
Evye Bataryası 315.- TL



Mix Banyo Yönlendiricisi 97.00 TL



Batarya Ay Takımı
Tek Delik 30.- TL



Dış Dişli

Robot Duş Mafsalı 75.00 TL



Duşakabin Tekeri Plastik
Çiftli 45.-TL/Tk
İki adet takım olarak satılır.



Batarya Ay Takımı
Çift Delik 30.- TL



İç Dişli

Mix Perlatör
Başlık 25.00 TL



Duşakabin Kulbu
Takım olarak satılır. 60.00 TL/Tk



Eymen Mix Banyo Bataryası 735.- TL



Eymen Mix Kısa Kuğu Lavabo Bataryası 465.- TL

Eymen Mix Uzun Kuğu Evye Bataryası 465.- TL



Elektrikli Hızlı Su Isıtıcı Banyo için 08004 1100.- TL

Elektrikli Hızlı Su Isıtıcı Mutfak için 36916 1100.- TL



Çamaşır Makinası Tahliye Hortumu
1.5 mt 24.00 TL
2 mt 35.00 TL
3 mt 40.00 TL



Çamaşır Makinası Giriş Hortumu
1.5 mt 88971 70.50 TL
2 mt 88972 82.50 TL
3 mt 88973 106.50 TL
4 mt 88974 136.50 TL
5 mt 88975 160.50 TL



Su Sebil Musluğu 35.- TL



Esnek Boyun Kubar Krom 50 cm MK1460 5.40 \$



Duş Hortumu 150 cm MK1450 1.95 \$

Duş Hortumu Örgülü 170 cm MK1452 3.60 \$



Duş Hortumu Lüks 180 cm MK1454 3.40 \$

PVC Duş Hortumu 155 cm MK1456 4.75 \$



PVC Duş Hortumu 155 cm 60.00 TL



3 Fonksiyonlu Kare Duş Başlığı MES 4229 4.00 \$



Taharet Hortumu 105 cm MK1457 4.60 \$



Taharet Hortumu Tabanlı set MK1458 6.10 \$



Duş Başlığı MK1430 0.97 \$



Duş Başlığı MK1432 1.65 \$



Duş Başlığı MK1434 2.30 \$



Duş Başlığı MK1436 1.85 \$
2 Fonksiyonlu



Duş Başlığı MK1438 2.60 \$



Duş Başlığı MK1440 2.50 \$



Duş Başlığı MK1442 3.20 \$



3 Fonksiyonlu Yuvarlak Krom Duş Başlığı MES 4224 3.95 \$



Duş Başlığı MES 4225 2.15 \$
3 Fonksiyonlu



Duş Başlığı MES 4226 2.52 \$
3 Fonksiyonlu



Krom Duş Başlığı MES 4220 1.25 \$



Lüks Duş Seti 200.- TL

Sürgülü Duş Seti 400.- TL
Mavi, Turkuaz, Turuncu

Paris Robot Duş Seti 1000.- TL

Elit Lux Robot Duş Seti 1125.- TL

Labirent Lux Robot Duş Seti 1125.- TL

Renkli Robot Duş Seti 800.- TL

Hitit Robot Duş Seti 1390.- TL

BKS Magic Robot Duş Seti 1775.- TL

Kare Robot Duş Başlık 390.- TL



Alya Banyo Bataryası 980.00 TL



Alya Lavabo Bataryası 745.00 TL



Alya Evye Bataryası 745.00 TL



Endüstriyel Evye Bataryası Sanayi Tipi 6 000.- TL

Çift musluk bağlantılı, tezgaha monte, kendi etrafında dönebilen elcek



Tekli Endüstriyel Batarya 4 000.- TL

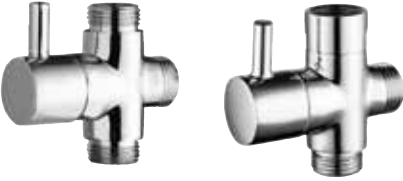

Robot Duş Yönlendirici Musluk
1/2 diş 280.00 TL
1/2 erkek 280.00 TL
3/4 erkek 280.00 TL

Delux Mix Lavabo Bataryası 1150.- TL

Delux Mix Evye Bataryası (Oynar Perlatörlü) 1150.- TL



Radyatör Vanası
1/2" Köşe tip 125.- TL
1/2" Düz tip 180.- TL
Termostatlı Radyatör Vanası 1/2" 550.- TL



Spiralli Kuğu Boru 75.- TL



Osmanlı Musluk 400.00 TL



Vakumlu Duş Askısı 75.- TL



Ankastre Duş Başlığı 210.- TL



Plastik Şamandıra 165.- TL



Emniyet Ventili Termosifon için 100.00 TL



Kombi Bağlantı Seti 455.00 TL



Purjör Anahtarı 12.00 TL



Ekselans Mix Banyo Bataryası 765.- TL



Ekselans Mix Kısa Kuğu Lavabo Bataryası 685.- TL

Ekselans Mix Uzun Kuğu Evye Bataryası 685.- TL



Sabunluk 75.00 TL
Diş Fırçalık 7 5.00 TL



Uzun Havluluk 100.00 TL



Yuvarlak Havluluk 80.00 TL



Tuvalet Kağıtlık 65.00 TL

Tuvalet Kağıtlık (Kapaklı) 75.00 TL



Kağıt Havluluk 70.00 TL

Kağıt Havluluk (Kapaklı) 81.00 TL



Bornoz Askılığı 65.00 TL



Etajer 99.00 TL



Askılık 2'li (Yapışkanlı) 87.00 TL



Kağıt Havluluk (Yapışkanlı) 95.00 TL



Tuvalet Kağıtlık Kapaklı (Yapışkanlı) 105.00 TL



Barem Banyo Aksesuar Seti 6'lı 600.00 TL



167 Kubbeli Ayna 275.00 TL

CLK Kubbeli Ayna 45x60 cm 450.00 TL



304 Kalite Sıvı Sabunluk Set Üstü 90.00 TL

Küre Set Üstü 110.00 TL



430 Kalite Klozet Fırçası Düz 85.00 TL

Delikli 110.00 TL

Vakumlu Krom Havluluk VK - 706 100.00 TL

Vakumlu Krom Yuvarlak Havluluk VK - 707 100.00 TL

Vakumlu Krom WC Kağıtlık VK - 708 90.00 TL

Vakumlu Krom KağıtHavluluk VK - 709 90.00 TL

Vakumlu KromTekli Askı VK - 700 60.00 TL



Pedallı Çöp Kovası (430 Kalite)

5 Lt 245.- TL
12 Lt 335.- TL
20 Lt 577.- TL
40 Lt 850.- TL



Dolap İçi Çöp Kovası 300.- TL
27 cm yükseklik, 16 cm çap



Ofis Tipi Çöp Kovası Delikli Boyalı 145.00 TL
130.00 TL



Sallanır Kapak Çöp Kovası (430 Kalite)

16 Lt 650.- TL
45 Lt 1200.- TL
80 Lt 1600.- TL



Krom Küllük No : 1 575.- TL
No : 2 615.- TL



Şampanya Küllük 785.- TL



Doğalgaz Vanası

1/2"	202.00 TL
3/4"	297.00 TL
1"	458.00 TL
1 1/4"	710.00 TL
1 1/2"	973.00 TL
2"	1550.00 TL



Kelebek Vana

1/2"	165.00 TL
3/4"	249.00 TL



Küresel Vana (Su)

1/2"	202.00 TL
3/4"	297.00 TL
1"	458.00 TL
1 1/4"	710.00 TL
1 1/2"	973.00 TL
2"	1550.00 TL



Mini Küresel Vana

1/4" - Kırmızı	113.00 TL
1/4" - Mavi	113.00 TL
3/8" - Kırmızı	113.00 TL
3/8" - Mavi	113.00 TL
1/2" - Kırmızı	115.00 TL
1/2" - Mavi	115.00 TL
3/4" Kırmızı	120.00 TL
3/4" Mavi	120.00 TL



Krom Uzatma

1/2"	
1 cm	20.00 TL
1.5 cm	25.00 TL
2 cm	27.00 TL
2.5 cm	31.00 TL
3 cm	34.00 TL
4 cm	43.00 TL
5 cm	53.00 TL



Redüksiyon

3/4x1/2"	24.00 TL
1x1 - 1/4"	42.00 TL
1-1/2 - 1/4"	65.00 TL
1 - 1/2"	37.00 TL
2 - 1/2"	167.00 TL
2x1	136.00 TL
2 - 1 1/2"	117.00 TL
2 - 1 1/4"	130.00 TL
1 - 3/4"	32.50 TL



Redüksiyon

3/4x1/2"	31.00 TL
1x1 - 1/4"	50.00 TL
1-1/2 - 1/4"	81.00 TL
1 - 1/2"	47.00 TL
2 - 1/2"	213.00 TL
2x1	172.00 TL
2 - 1 1/2"	148.00 TL
2 - 1 1/4"	165.00 TL



Doğalgaz Bağlantı Hortumu

Fırın, Ocak, Soba	200.00 TL
1/2" - 1/2" - 90 cm	

Makaronlu Boru

1/2" - 1/2" - 50 cm	265.00 TL
1/2" - 1/2" - 75 cm	295.00 TL
1/2" - 1/2" - 100 cm	325.00 TL
1/2" - 1/2" - 125 cm	340.00 TL
1/2" - 1/2" - 150 cm	388.00 TL
1/2" - 1/2" - 200 cm	448.00 TL
3/4" - 3/4" - 60 cm	295.00 TL



Su Flex Hortumu

3/8" - 3/8" - 30 cm	40450	59.70 TL
3/8" - 3/8" - 50 cm	40451	71.70 TL
3/8" - 3/8" - 70 cm	40452	83.70 TL
3/8" - 3/8" - 100 cm	40453	101.70 TL
3/8" - 1/2" - 30 cm	40460	66.45 TL
3/8" - 1/2" - 50 cm	40461	78.45 TL
3/8" - 1/2" - 70 cm	40462	90.45 TL
3/8" - 1/2" - 100 cm	40463	108.45 TL
1/2" - 1/2" - 30 cm	40470	73.20 TL
1/2" - 1/2" - 50 cm	40471	85.20 TL
1/2" - 1/2" - 70 cm	40472	97.20 TL
1/2" - 1/2" - 100 cm	40473	115.20 TL
1/2" - 3/4" - 30 cm	40480	80.70 TL
1/2" - 3/4" - 50 cm	40481	92.70 TL
1/2" - 3/4" - 70 cm	40482	104.70 TL
1/2" - 3/4" - 100 cm	40483	122.70 TL

3/4" - 3/4" - 30 cm	88.20 TL
3/4" - 3/4" - 40 cm	94.20 TL
3/4" - 3/4" - 50 cm	100.20 TL

Batarya Bağlantı Flex Hortumu

40 cm	63.45 TL
50 cm	69.45 TL
70 cm	81.45 TL
80 cm	87.45 TL
100 cm	99.45 TL

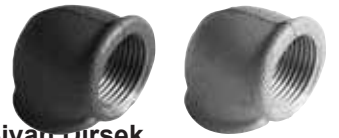

Siyah Dirsek

1/2"	23.00 TL
3/4"	34.00 TL
1"	51.85 TL
1 - 1/4"	110.00 TL
1 - 1/2"	175.00 TL
2"	200.00 TL

Galvaniz Dirsek

1/2"	29.00 TL
3/4"	43.75 TL
1"	66.50 TL
1 - 1/4"	137.70 TL
1 - 1/2"	219.00 TL
2"	250.00 TL

Siyah TE

1/2"	34.00 TL
3/4"	57.00 TL
1"	81.00 TL
1 - 1/4"	150.00 TL
1 - 1/2"	227.00 TL
2"	330.00 TL

Galvaniz TE

1/2"	42.00 TL
3/4"	72.00 TL
1"	104.00 TL
1 - 1/4"	186.00 TL
1 - 1/2"	285.00 TL
2"	408.00 TL



Siyah Nipel

1/2"	25.00 TL
3/4"	32.50 TL
1"	44.00 TL
1 - 1/4"	80.00 TL
1 - 1/2"	94.00 TL
2"	161.00 TL

Galvaniz Nipel

1/2"	31.00 TL
3/4"	41.00 TL
1"	57.00 TL
1 - 1/4"	99.00 TL
1 - 1/2"	115.00 TL
2"	205.00 TL



Siyah Manşon

1/2"	29.00 TL
3/4"	39.00 TL
1"	49.00 TL
1 - 1/4"	80.00 TL
1 - 1/2"	112.00 TL
2"	167.00 TL

Galvaniz Manşon

1/2"	36.00 TL
3/4"	49.00 TL
1"	62.00 TL
1 - 1/4"	101.00 TL
1 - 1/2"	144.00 TL
2"	213.00 TL

Kör Tapa

1/2"	21.00 TL	26.00 TL
3/4"	28.00 TL	34.00 TL
1"	31.00 TL	37.00 TL
1 - 1/4"	55.00 TL	68.00 TL
1 - 1/2"	70.00 TL	86.00 TL
2"	121.00 TL	151.00 TL



Lavabo Ayak Kombinasyonu
50x60 cm 2150.00 TL

2 Parça Klozet Takımı 3150.00 TL
Alttan çıkışlı klozet ve rezervuar
(yan malzeme dahil)

2 Parça Klozet Takımı 4850.00 TL
Duvara Sıfır

Klozet Montaj Vidası 23.00 TL
Lavabo Montaj Vidası 23.00 TL
Şofben Kancası 23.00 TL
Orta Tharet Çubuğu 20.00 TL
Orta Tharet Çubuğu Ucu Krom 30.00 TL
34 cm

Klozet Kapak Montaj Vidası 30.00 TL

Klozet kapak Montaj Vidası 95.00 TL
Metal



Helataşı Çevre Yıkamalı
Arkadan Çıkışlı 1200.00 TL



Atlas Lord 88 Rezervuar
Klasik Asma 325.00 TL
Basmalı 340.00 TL



Paslanmaz Yer Süzgeci (10x10 cm)
Kare Yandan 32'lik 55.00 TL
Kare Yandan 50'lik 55.00 TL



Plastik Yer Süzgeci
10X10 32.00 TL
15X15 47.00 TL

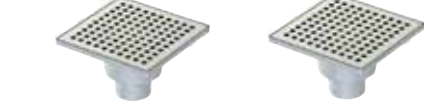

Paslanmaz Yer Süzgeci (15x15 cm)
Kare Alttan 50'li 105.00 TL
Kare Alttan 70'lik 105.00 TL
Kare Yandan 70'lik 105.00 TL
Kare Yandan 50'lik 105.00 TL



Taharet Seti
USO UT-000155 130.00 TL



Tutunma Barı
40 cm 420.00 TL



Lavabo
50x50 cm 975.00 TL
35x45 cm 785.00 TL



Duş Kanalı Seramik Uyumlu
33 cm 260.00 TL
40 cm 290.00 TL
50 cm 330.00 TL
60 cm 350.00 TL



Çamaşır Makinası Çıkışlı
Körüklü Sifon 30.00 TL
Gırtlak Lavabo Eveye
Sifonu 35.00 TL
Uzun Gırtlak Lavabo
Eveye Sifonu 44.00 TL
Çöpçak Kafa Körüklü Eveye Sifonu
Geniş Kafa 155.00 TL



Körüklü Kada 70641 70.00 TL
Ekzantirik Klozet Kadası 40.00 TL

USO Akdeniz
Klozet Kapağı
UR-000503 195.00 TL



PVC
Klozet Kapağı 160.00 TL



Desenli
Klozet Kapağı 185.00 TL



Amortisörlü
Klozet Kapağı 240.00 TL



1/2" Flatör 105.00 TL
USO UR-000506 190.00 TL
Basmalı Rezervuar İç Takım
İç Takım 10.00 TL
Sünger Conta



Lavabo Süzgeci Metal 15.00 TL

Lavabo Tapası Metal 45.00 TL
Krom



Beşik Duş Mafsalı 15.00 TL



Beşik Duş Mafsalı Lux 27.- TL



Redüksiyon

25 / 20	3.00 TL
32 / 20	3.80 TL
32 / 25	4.50 TL
40 / 20	7.65 TL
40 / 25	7.80 TL
40 / 32	8.70 TL
50 / 20	12.10 TL
50 / 25	12.35 TL
50 / 32	13.40 TL
50 / 40	15.30 TL
63 / 32	30.30 TL



Kapama Başlığı

20	2.85 TL
25	3.75 TL
32	6.50 TL



Kör Tapa

20	1.95 TL
25	2.20 TL



TE Parça

20	4.95 TL
25	6.95 TL
32	13.90 TL
40	23.15 TL
50	45.90 TL



Dış Dişli TE

20 - 1/2"	38.10 TL
20 - 3/4"	52.85 TL
25 - 1/2"	44.00 TL
25 - 3/4"	54.50 TL
32 - 1"	96.80 TL



İç Dişli TE

20 - 1/2"	29.65 TL
20 - 3/4"	38.90 TL
25 - 1/2"	37.15 TL
25 - 3/4"	44.25 TL
32 - 1"	97.40 TL



İç Dişli Rakor

20 - 1/2"	35.85 TL
20 - 3/4"	35.25 TL
25 - 1/2"	28.20 TL
25 - 3/4"	36.15 TL
32 - 1"	93.85 TL



Dış Dişli Rakor

20 - 1/2"	32.85 TL
20 - 3/4"	50.75 TL
25 - 1/2"	38.05 TL
25 - 3/4"	49.25 TL
32 - 1"	116.15 TL



İç Dişli Dirsek

20 - 1/2"	28.27 TL
20 - 3/4"	39.15 TL
25 - 1/2"	30.10 TL
25 - 3/4"	39.40 TL
32 - 3/4"	55.00 TL
32 - 1"	85.15 TL



Dış Dişli Dirsek

20 - 1/2"	35.00 TL
20 - 3/4"	52.00 TL
25 - 1/2"	41.85 TL
25 - 3/4"	52.75 TL
32 - 1"	100.50 TL



İç Dişli Oynar Başlıklı Rakor

20 - 1/2"	59.85 TL
25 - 3/4"	88.00 TL
32 - 1"	115.50 TL



Dış Dişli Oynar Başlıklı Rakor

20 - 1/2"	67.10 TL
25 - 3/4"	99.50 TL
32 - 1"	138.60 TL



Sıva Altı Vana

20 mm	96.80 TL
25 mm	115.50 TL
32 mm	178.00 TL



Küresel Vana Plastik

20 mm	102.00 TL
25 mm	129.00 TL
32 mm	180.00 TL
40 mm	408.00 TL



Sıva Altı Batarya Bağlantısı

20 - 1/2"	30.25 TL
25 - 1/2"	37.50 TL



Batarya Bağlantısı Çiftli

20 - 1/2"	92.10 TL
25 - 1/2"	125.50 TL



İnegal TE

25 x 20 x 25	8.15 TL
32 x 25 x 32	15.15 TL



Çiftli Kelepçe

20 mm	3.75 TL
25 mm	4.95 TL
32 mm	5.70 TL



Tekli Kelepçe

20 mm	2.20 TL
25 mm	2.65 TL
32 mm	3.15 TL



Köşe Düzeltici

6.60 TL



Gri/ Beyaz PN20 Borular

20	22.25 TL/mt
25	34.25 TL/mt
32	63.60 TL/mt
40	98.50 TL/mt
50	156.95 TL/mt



Köprü / Kavis

20	11.65 TL
25	19.10 TL
32	39.65 TL



Dirsek 90°

20	3.25 TL
25	5.05 TL
32	9.50 TL
40	19.50 TL
50	34.90 TL
63	67.00 TL



Dirsek 45°

20	4.45 TL
25	6.50 TL
32	10.55 TL
40	18.60 TL



Manşon

20	2.30 TL
25	3.75 TL
32	7.20 TL
40	12.00 TL
50	18.98 TL



Dübelle Yer Tespit Kroşesi

1.15 TL



Köşe Emniyet Ventili

1/2	535.00 TL
3/4	667.00 TL
1	888.00 TL
1 1/4	1295.00 TL
1 1/2	1425.00 TL
2	1895.00 TL



Düz Emniyet Ventili

1/2	490.00 TL
3/4	615.00 TL
1	820.00 TL
1 1/4	1162.00 TL
1 1/2	1355.00 TL
2	1745.00 TL



Su Saat Rakoru 3/4"

Uzun	65.00 TL
Kısa	58.00 TL



Düz Radyatör Rakoru

1/2	110.00 TL
3/4	167.00 TL
1	234.00 TL
1 1/4	335.00 TL
1 1/2	495.00 TL
2	865.00 TL



Köşe Radyatör Rakoru

1/2"	125.00 TL
3/4"	185.00 TL
1"	280.00 TL



Konik Rakor

1/8	108.00 TL
1/4	108.00 TL
3/8	135.00 TL
1/2	155.00 TL
3/4	204.00 TL
1	248.00 TL
1 1/4	432.00 TL
1 1/2	545.00 TL
2	795.00 TL



Şiber Vana

1/2"	268.00 TL
------	-----------



Sarı Lüle

1/4 x 1/8	24.65 TL
1/4 x 1/4	22.15 TL
1/4 x 3/8	35.00 TL
1/4 x 1/2	36.00 TL
3/8 x 1/8	34.15 TL
3/8 x 3/8	34.15 TL
3/8 x 1/2	37.50 TL
1/2 x 1/8	37.50 TL
1/2 x 1/2	56.00 TL
1/2 x 3/4	56.00 TL
1 x 1/2	72.00 TL
1 x 3/4	75.00 TL



Sarı Dişi Oynak Hortum Rakoru

1/4 x 6	45.00 TL
1/4 x 8	45.00 TL
1/4 x 10	45.00 TL
3/8 x 6	52.00 TL
3/8 x 8	52.00 TL
3/8 x 10	52.00 TL
1/2 x 10	92.00 TL
1/2 x 12	99.00 TL
1/2 x 14	105.00 TL
1/2 x 16	119.00 TL
3/4 x 16	138.00 TL



Sarı Dörtüyl Kruva

1/4	68.00 TL
3/8	72.00 TL
1/2	88.00 TL
3/4	185.00 TL



Hırsız Kelepçe 98.00 TL



Çift Çatal

50/50	48.65 TL
75/50	69.15 TL
75/75	107.45 TL
110/50	103.50 TL
110/75	158.00 TL
110/110	167.00 TL
125/75	228.00 TL
125/110	241.00 TL
125/125	350.00 TL
160/160	702.00 TL



Dublex Atık Su Boruları

50/250	26.10 TL
50/500	39.90 TL
50/1000	64.00 TL
50/2000	124.00 TL
50/3000	185.00 TL
75/250	45.00 TL
75/500	64.00 TL
75/1000	107.00 TL
75/2000	207.00 TL
75/3000	307.00 TL
110/250	66.00 TL
110/500	100.00 TL
110/1000	163.00 TL
110/2000	317.00 TL
110/3000	454.00 TL
125/250	87.00 TL
125/500	129.00 TL
125/1000	210.00 TL
125/2000	405.00 TL
125/3000	598.00 TL
160/250	128.00 TL
160/500	219.00 TL
160/1000	353.00 TL
160/2000	675.00 TL
160/3000	993.00 TL



Dirsek (45° Açık)

50	12.95 TL
75	22.70 TL
110	44.85 TL
125	65.50 TL
160	126.35 TL



Dirsek (87° Kapalı)

50	15.30 TL
75	29.50 TL
110	59.50 TL
125	82.40 TL
160	166.00 TL



Atık Su Kapama Başlığı

50	9.65 TL
75	17.40 TL
110	23.65 TL



Atık Su Boru Contası

50'lik	4.40 TL
70'lik	5.50 TL
100'lük	6.60 TL
125'lik	8.80 TL



Redüksiyon

75/50	20.35 TL
110/50	32.70 TL
110/75	34.25 TL
125/75	62.15 TL
125/110	63.15 TL
160/125	135.00 TL



Tek Çatal 45°

50/50	26.15 TL
75/50	39.10 TL
75/75	58.80 TL
110/50	62.25 TL
110/75	87.50 TL
110/110	108.00 TL
125/110	155.00 TL
160/110	265.00 TL
160/160	408.00 TL



Te Çatal

50/50	27.75 TL
75/50	41.80 TL
75/70	52.80 TL
110/50	61.60 TL
110/75	85.50 TL
110/110	94.10 TL
125/75	168.00 TL
125/110	146.00 TL
125/125	170.00 TL
160/160	350.00 TL



Kayar Manşon

50 mm	18.70 TL
75 mm	29.70 TL
110 mm	52.80 TL
125 mm	89.70 TL
150 mm	161.70 TL



Pis Su Kelepçe

50 mm	6.45 TL
75 mm	10.60 TL
110 mm	19.50 TL



ES Sifon

110 mm	150.00 TL
--------	-----------

**Sarı Nipel**

1/8	18.15 TL
1/4	23.10 TL
3/8	19.70 TL
1/2	27.30 TL
3/4	35.00 TL
1	55.00 TL
1 1/4	125.00 TL

**Sarı Manşon**

1/8	20.00 TL
1/4	28.60 TL
3/8	34.65 TL
1/2	42.00 TL
3/4	56.00 TL
1	90.00 TL

**Sarı Dirsek**

1/8	63.00 TL
1/4	63.00 TL
3/8	74.20 TL
1/2	103.60 TL
3/4	126.60 TL
1	218.20 TL

**Sarı Kör Tapa Dişi**

1/8	26.95 TL
1/4	29.61 TL
3/8	27.72 TL
1/2	37.90 TL
3/4	50.40 TL
1	87.08 TL
1 1/4	180.60 TL
1 1/2	232.40 TL

**Sarı Klape**

3/4	97.00 TL
1	105.00 TL
1 1/4	180.00 TL
1 1/2	230.00 TL
2	301.00 TL
2 1/2	490.00 TL
3	780.00 TL

**Erkek Hortum Rakoru**

Ağır Tip	35.00 TL
1/4 x 6 mm	35.00 TL
1/4 x 8 mm	35.00 TL
1/4 x 10 mm	35.00 TL
1/4 x 12 mm	35.00 TL
1 x 20 mm	75.00 TL
1 x 27 mm	75.00 TL

**Sarı TE**

1/8	60.00 TL
1/4	65.00 TL
3/8	60.00 TL
1/2	86.00 TL
3/4	135.00 TL
1	201.00 TL

**Sarı Kuyruklu Dirsek**

1/8	58.00 TL
1/4	55.00 TL
3/8	55.00 TL
1/2	61.00 TL
3/4	110.00 TL
1	165.00 TL

**Sarı Orantılı Nipel**

1/4 x 1/8	23.75 TL
3/8 x 1/8	28.15 TL
3/8 x 1/4	28.15 TL
1/2 x 1/4	32.70 TL
1/2 x 3/8	35.65 TL
3/4 x 1/2	37.20 TL
1 x 1/2	62.70 TL
1 x 3/4	67.00 TL

**Sarı Erkek Tapa**

1/8	18.15 TL
1/4	18.15 TL
3/8	23.00 TL
1/2	25.50 TL
3/4	36.50 TL
1	56.50 TL

**Sarı Erkek Hortum Rakoru**

Hafif Tip	
1/2 x 6 mm	38.00 TL
1/2 x 8 mm	38.00 TL
1/2 x 10 mm	38.00 TL
1/2 x 13 mm	41.00 TL
1/2 x 16 mm	41.00 TL
3/4 x 20 mm	54.00 TL
1 x 27 mm	177.00 TL
1 1/4 x 33 mm	134.00 TL
1 1/2 mm	146.00 TL
2	268.00 TL

**YE Çatal 2'li**

1/2 - 2'li	166.60 TL
1/2 - 3'lü	215.60 TL

**Sarı Redüksiyon**

1/4 x 1/8	20.85 TL
3/8 x 1/8	20.00 TL
3/8 x 1/4	20.00 TL
1/2 x 1/8	36.00 TL
1/2 x 1/4	26.85 TL
1/2 x 3/8	24.65 TL
3/4 x 1/8	65.00 TL
3/4 x 1/4	60.00 TL
3/4 x 3/8	60.00 TL
3/4 x 1/2	35.00 TL
1 x 1/4	75.00 TL
1 x 3/8	75.00 TL
1 x 1/2	63.00 TL
1 x 3/4	63.00 TL
1 x 1/4 x 1/2	135.00 TL

**Sarı Üçlü Hortum TE**

6 mm	49.50 TL
8 mm	57.26 TL
10 mm	70.00 TL
12 mm	89.60 TL
16 mm	169.10 TL
20 mm	291.00 TL

**Sarı Hortum Eki**

6 mm	24.29 TL
8 mm	27.72 TL
10 mm	37.73 TL
12 mm	58.52 TL
16 mm	84.00 TL
20 mm	93.80 TL

**Sarı Dörtlü Hortum TE**

6 mm	42.00 TL
8 mm	54.60 TL
10 mm	75.60 TL
12 mm	113.40 TL
16 mm	232.40 TL
20 mm	483.00 TL

**Sarı Hortum Rakoru Dişi**

1/4 x 6	49.35 TL
1/4 x 8	49.35 TL
1/4 x 10	49.35 TL
3/8 x 6	61.60 TL
3/8 x 8	61.60 TL
3/8 x 10	61.60 TL
1/2 x 6	65.80 TL
1/2 x 8	65.80 TL
1/2 x 10	65.80 TL
1/2 x 12	65.80 TL
1/2 x 14	86.80 TL
3/4 x 16	114.80 TL
3/4 x 12	114.80 TL

**Krom Emniyet Ventili**

1/2	210.00 TL
-----	-----------

**Pislik Tutucu (Filtre)**

1/2	100.00 TL
3/4	145.00 TL
1	114.00 TL
1 1/4	400.00 TL
1 1/2	490.00 TL
2	750.00 TL

**Dik Çekvalf**

1/2	100.00 TL
3/4	130.00 TL
1	190.00 TL
1 1/4	250.00 TL
1 1/2	365.00 TL
2	500.00 TL

**Çalparalı Çekvalf**

1/2	150.80 TL
3/4	185.00 TL
1	255.00 TL
1 1/4	415.00 TL
1 1/2	550.00 TL
2	750.00 TL

**Depo Bağ Rakoru (Sintine)**

1/2	137.20 TL
3/4	198.80 TL
1	400.40 TL
1 1/4	707.00 TL
1 1/2	931.03 TL
2	1450.00 TL

Ekru Pul

1/4	14.30 TL
3/8	23.10 TL
1/2	37.49 TL
3/4	92.01 TL
1	91.17 TL
1 1/4	107.80 TL
1 1/2	131.60 TL
2	166.60 TL
2 1/2	249.20 TL
3	392.00 TL
4	746.80 TL

**Ekru Somun**

1/4	14.20 TL
3/8	23.20 TL
1/2	33.25 TL
3/4	52.01 TL
1	91.28 TL
1 1/4	107.80 TL
1 1/2	131.60 TL
2	166.60 TL
2 1/2	240.20 TL
3	392.00 TL
4	744.80 TL



Kestirme Fırçalar (Libra)

No:1	26131	19.65 TL
No:1.5	26132	22.15 TL
No:2	26133	26.95 TL
No:2.5	26134	32.15 TL
No:3	26135	40.40 TL
No:4	26136	52.95 TL



Yağlı Boya Fırçaları (Luna)

No:1	26141	25.60 TL
No:1.5	26142	31.75 TL
No:2	26143	39.95 TL
No:2.5	26144	46.75 TL
No:3	26145	59.25 TL
No:4	26146	77.25 TL



Akrobat Yağlı Boya Fırçaları (Luna)

No:3	26123	84.00 TL
No:4	26124	92.15 TL



Kalorifer Fırçaları

No:2	26116	45.00 TL
No:3	26117	55.00 TL



Boya Ruloları

5 cm Parmak		29.50 TL
10 cm Parmak	26171	30.75 TL
20 cm, İç cephe	26169	71.50 TL
25 cm, İç cephe	26170	79.00 TL
20 cm, Dış cephe	11687	71.50 TL
25 cm, Dış cephe	12257	79.00 TL
10 cm, Postaki Rulo		239.00 TL



Saten Yedek Boya Ruloları

5 cm Parmak	12615	13.20 TL
10 cm Parmak	26175	13.75 TL
20 cm, İç cephe	26167	58.00 TL
25 cm, İç cephe	26177	64.00 TL
20 cm, Dış cephe	01258	58.00 TL
25 cm, Dış cephe		64.00 TL
Dekor Parmak Rulo 10 cm		



Mercan Yedek Rulo

10 cm		27.00 TL
-------	--	----------

Sünger Yedek Rulo

Parmak 10 cm		16.40 TL
--------------	--	----------



Kirpi Boya Rulo Takım

20 cm		200.00 TL
25 cm		205.00 TL

Kirpi Yedek Rulo

20 cm		164.00 TL
25 cm		171.00 TL

Moher Boya Rulo Takım

10 cm		33.00 TL
20 cm		115.00 TL

Moher Yedek Rulo

10 cm		15.00 TL
20 cm		110.00 TL

Epoksi Boya Rulo Takım

20 cm		110.00 TL
25 cm		124.00 TL

Epoksi Boya Yedek Rulo

20 cm		89.30 TL
25 cm		102.00 TL



İzolasyon Fırçası

26150		117.00 TL
-------	--	-----------



Badana Fırçası

Uzun Seyrek Kıl		102.00 TL
Kısa Sık Kıl		92.00 TL



Su Atma Fırçası (Kıl)

26128		101.75 TL
-------	--	-----------



Boya Tavaşı

32x36 cm		47.30 TL
----------	--	----------



Çok Amaçlı Spatula

8 cm		100.00 TL
------	--	-----------



Alçı Sistre

30 cm		89.00 TL
-------	--	----------



Protik Hobi Seti

10cm		121.00 TL
16x30cm boya tavaşı, 10cm sünger rulo yedek		



Pratik Boyacı Seti

10cm		152.00 TL
16x30cm boya tavaşı, kestirme fırça, 10cm parmak rulo takımı 10cm parmak rulo yedek		



Touch Pratik Fırça (Luna)

No:40		45.00 TL
No:50		47.00 TL
No:60		51.00 TL
No:70		60.00 TL



Suluboya Rötüş Fırça (Luna)

yuvarlak uçludur.		
No:8		21.80 TL
No:10		21.80 TL
No:12		21.80 TL



Nalbur Tip Kalem Fırça

No:6-8-10-12		15.00 TL
No:14-16-18		17.15 TL
No:20-22-24		18.50 TL



Epoksi Çivili Ayakkabı

		302.00 TL
--	--	-----------



Sıva Teknesi

62x44x18 cm		02422
-------------	--	-------



Beta Sprey Boya (Selülozik)

Normal 200 ml	3.80 €
Metalik 200 ml	4.20 €

Beta Sprey Boya (Akrilik)

Normal 400 ml	4.20 €
Metalik 400 ml	4.45 €



Akçalı Sprey Boya

Normal 400 ml	4.85 €
Metalik 400 ml	5.80 €
Vernik 400 ml	4.85 €

Normal Renkler

- 301 Parlak Beyaz
- 302 Krem
- 305 Açık Kahve
- 306 Gri
- 307 Orta Gri
- 309 Turuncu
- 313 Yeşil
- 314 Açık Yeşil
- 316 Krom Sarı
- 319 Makine Kırmızı
- 336 Turkuaz
- 320 Kırmızı
- 322 Mor
- 324 Boncuk Mavi
- 325 Kahverengi
- 326 Parlak Siyah
- 526 Mat Siyah
- 5002 Lacivert
- 6005 Yosun Yeşil

Metalik Renkler

- 310 Altın Yıldız
- 802 Gümüş
- 357 Metalik Gri
- 513 Floresan Yeşil
- 516 Floresan Sarı
- 519 Floresan Kırmızı
- 522 Floresan Kavuniçi
- 524 Floresan Boncuk Mavi
- 902 Alüminyum
- 403 Alüminyum Soba
- 702 Oto Jant Boyası
- 7016 Antrasit Gri



MOBEL Selülozik Tiner

0.4 Lt - 0.34 Kg	3.75 \$
1/1 - 0.80 Kg	6.04 \$
3 Lt - 2.50 Kg	15.90 \$
10/1 - 10 Kg	57.00 \$

CRN Selülozik Tiner

10 Kg	40.00 \$
-------	----------



MOBEL Sentetik Tiner

1/2 - 0.25 Kg - 320 ml	1.80 \$
1/1 - 0.50 Kg - 500 ml	2.80 \$
Küçük GLN	8.10 \$
1.17 Kg - 1500 ml	
Büyük GLN	12.60 \$
1.95 Kg - 2500 ml	
10/1 - 9.40 Kg - 12 Lt	60.00 \$



Redacril Rapid Endüstriyel Boya 1. Grup

Koyu gri, mat siyah	
0.75 kg	210.00 TL
2.75 kg	671.00 TL
17 kg	3433.00 TL

Redacril Rapid Endüstriyel Boya 2. Grup

Sarı, beyaz, açık mavi, turuncu, gri	
0.75 kg	232.00 TL
2.75 kg	732.00 TL
17 kg	3765.00 TL

Redacril Rapid Endüstriyel Boya 3. Grup

metalik gri, kırmızı, mavi, antrasit, gri, yeşil	
0.75 kg	268.00 TL
2.75 kg	885.00 TL
17 kg	4600.00 TL



Redacril Antipas

0.85 Lt	161.00 TL
2.75 Lt	426.00 TL
17 Lt	2260.00 TL



Antipas Boyalar 2. Kalite

2.80 kg	300.- TL
18 kg - Gri	1000.- TL
18 kg - Kırmızı - Siyah	1100.- TL



Redacril Rapid Astar

17 Kg	2028.- TL
-------	-----------



Redacril Cam Cila

0.70 Lt	278.00 TL
2.30 Lt	760.00 TL

Redacril Koza Tex Vervikli Ahşap Koruyucu

0.70 kg	194.00 TL
2.30 kg	545.00 TL
12 kg	2640.00 TL



Sentetik Boya

0.70 Lt	221.00 TL
2.2 Lt	657.00 TL
17 Lt	3564.00 TL



Yat Vernik

12 kg	3629.00 TL
2.30 kg	760.00 TL
0.75 kg	278.50 TL



Redacril Alüminyum Yıldız Boya

0.25 Lt	121.00 TL
0.75 Kg	285.00 TL
2.5 Kg	861.00 TL
15 Kg	4175.00 TL



Redacril Exterior Silikonlu Dış Cephe Boyası

Silikonlu, esnek, antibakteriyel, küf önleyici dış cephe boyası
7.5 Lt 1433.00 TL
15 Lt 2831.00 TL



Redacril Koza İpeksi

Silikonlu, esnek, silinebilir, antibakteriyel, küf önleyici, ipeksi iç cephe boyası
2.5 Lt 577.00 TL
7.5 Lt 1589.00 TL
15 Lt 3145.00 TL



EGESAN Endüstriyel Rapid Boya (1. Grup) Beyaz, krom, sarı, kahverengi, turuncu, gri, mavi, yeşil

0.7 Lt 8.50 \$
2.2 Lt 19.00 \$
15 Kg 90.00 \$



Redacril Koza Grenli Silikonlu Dış Cephe Boyası

Silikonlu, esnek, antibakteriyel, küf önleyici grenli dış cephe boyası
25 Kg 2319.- TL



Redacril Koza Soft Mat

Silikonlu, esnek, silinebilir, antibakteriyel, küf önleyici, soft iç cephe boyası
3.5 Lt 436.20 TL
15 Lt 2733.00 TL



EGESAN Endüstriyel Rapid Boya (2. Grup) Bayrak kırmızı, traktör turuncu, lacivert

15 Kg 110.- \$



Redacril Koza Dış Cephe Astarı

Silikonlu, dolgulu dış cephe astarı
10 Kg 764.00 TL
20 Kg 1491.00 TL



Redacril Koza Silikonlu Mat

Silikonlu, mat iç cephe boyası
3.5 Lt 355.00 TL
10/1 Lt 959.00 TL
20/1 Lt 1792.00 TL



EGESAN Endüstriyel Astar

1 Kg - Gri 5.50 \$
3 Kg - Gri 11.50 \$
18 Kg - Gri 53.00 \$
1 Kg - Kırmızı 5.95 \$
3 Kg - Kırmızı 12.50 \$
18 Kg - Kırmızı 59.00 \$



Redacril Tavan Boyası

Mat tavan boyası
1 Lt 96.00 TL
GL 4/1 225.00 TL
GL 10/1 586.00 TL
GL 17.5 Kg 1016.00 TL
GL 20 Kg 1131.00 TL



Redacril Ekstra Plastik

Mat iç cephe boyası
GL 4/1 285.60 TL
GL 10/1 759.30 TL
GL 20/1 1505.40 TL



İsonem MS 82

1 Kg 29.- \$
Nem boyası, nemli ve rutubetli duvarlar için

İsonem Liquid Glass

2 Kg 59.- \$
cam, ahşap, seramik, mermer, granit gibi yüzeylerde şeffaf kaplama ile su yalıtımı sağlar.



Redacril Koza Ritmix İç Cephe Astarı

Akrilik reçine esaslı, su bazlı
3.5 Lt 228.00 TL
10 Lt 595.00 TL



Redacril Plastik Su Bazlı

Mat iç cephe boyası
GL 10/1 759.- TL
GL 20/1 1505.- TL



Lack Kendinden Vernikli Hobi Boyası
120 cc 99.00 TL
550 cc 408.00 TL

4001 - Beyaz
4003 - Fildişi
4004 - Krem
4006 - Bej
4009 - Sarı
4013 - Pudra Pembe
4016 - Turuncu
4018 - Gri Yeşil
4020 - Bayrak Kırmızı
4022 - Bordo
4024 - Mor
4026 - Menekşe
4028 - Antik Lavanta
4031 - Mavi
4032 - Lacivert
4035 - Kobalt Turkuaz
4038 - Fıstık Yeşili
4041 - Yağ Yeşili
4048 - Kaynak Gri
4050 - Siyah



Multi Surface Hobi Boyası
120 cc 75.00 TL
550 cc 275.00 TL

1001 - Beyaz
1003 - Fildişi
1004 - Krem
1006 - Vanilya
1009 - Bej
1016 - Sarı
1017 - Saman
1023 - Gül Kurusu
1028 - Şeker Pembe
1037 - Scarlet Kırmızı
1041 - Bordo
1044 - Mor
1048 - Lavanta
1052 - Açık Mavi
1055 - Mavi
1062 - Turkuaz
1032 - Turuncu
1070 - Kereviz
1074 - Fıstık Yeşili
1087 - Oksit Kahve
1099 - Karbon Siyah
1019 - Oksit Sarı



Akriolik Hobi Boyası
120 cc 66.00 TL
550 cc 237.00 TL

İnce Kum (Pearlsand) Hobi Boyası
120 cc 115.00 TL
550 cc 480.00 TL

Chalkart Hobi Boyası
120 cc 105.00 TL
550 cc 345.00 TL



Multi Surface Yıldız (Gildings) Hobi Boyası
120 cc 119.00 TL
550 cc 490.00 TL

5001 - Altın
5008 - Gümüş
5010 - Bakır

Multi Surface Metalize Yıldız (Gildings) Hobi Boyası
120 cc 140.00 TL
550 cc 580.00 TL

Multi Surface Hilight Yıldız (Gildings) Hobi Boyası
120 cc 140.- TL

Akriolik Simli (Acrylic Glitter) Hobi Boyası
120 cc 140.- TL



Vernik (Varnish) 801 - Su Bazlı Parlak Vernik
120 cc 86.00 TL
550 cc 275.00 TL

Vernik (Varnish) 803 - Su Bazlı Mat Vernik
120 cc 86.00 TL
550 cc 275.00 TL

Vernik (Varnish) 804 - Poliüretan Parlak Vernik
120 cc 126.00 TL
550 cc 432.00 TL

Vernik (Varnish) 806 - Taş Vernik
120 cc 121.00 TL
550 cc 468.00 TL

Koruyucu Wax
120 cc 155.00 TL

Karatahta (Chalkboard) Hobi Boyası
120 cc 81.00 TL
550 cc 278.00 TL

Eskitme Pudrasu (Liquid Chalk)
120 cc 110.00 TL
550 cc 460.00 TL

Wax Eskitme Kremi (Antique Cream)
120 cc 99.00 TL
550 cc 420.00 TL

Eskitme Antiquin 140.00 TL
120 cc
550 cc

Parmak Yıldız (Finger Wax)
40 cc 191.00 TL

Boyutlu Boya (Dimensional)
20 cc 65.00 TL
20 cc - Simli 65.00 TL
20 cc - Yıldız 65.00 TL

Sıvı Cam (Gloss Coating)
1 kg 955.- TL

Unicolor (Renk Tonlandırma)
32 renk 111.- TL

Hobi Dekupaj Tutkalı
8001 94.00 TL

Transfer Tutkalı
8002 78.00 TL

Peçete Tutkalı
8003 86.00 TL

Çatlatma Medium
8008 88.00 TL

Simli Altın
5801 140.00 TL



Seramik Gazbeton Yapıştırıcısı

25 Kg Kraft torba - Beyaz

200.00 TL / Pk

25 Kg Kraft torba - Gri

126.00 TL / Pk

1 Kg

15.00 TL

Seramik, fayans, karo vb malzemelerin yüzeylere yapıştırılmasında kullanılan çimento esaslı yapıştırıcıdır.

5,5 - 6,5 lt. temiz su ile 25 kg.'lık seramik yapıştırma harcı, düşük devirli bir mikser veya mala ile homojen bir karışım elde edinceye kadar karıştırılır. Harç, 5 dakika dinlendirilir. Uygulama öncesinde tekrar karıştırılır. Harç, yüzeye uygulanıp taraklanarak ve lastik sokmak yardımıyla 20 dk içerisinde yüzeye yapıştırılır Büyük boyuttaki seramikler için hem uygulama yapılacak yüzeye, hem de seramiğin arkasına harç sürülerek yapıştırılmalıdır. İç mekanlar da yatay ve düşey yüzeylerde, dış mekanlarda ise zemin uygulamalarında, çimento bazlı sıva, şap ve beton üzerine uygulanır.



Flex Elastik Karakterli Mermer, Doğaltaş ve Porselen Karo Yapıştırıcısı

25 Kg Kraft torba - Gri

208.00 TL / Pk

25 Kg Kraft torba - Beyaz

243.00 TL / Pk



Cipo Hazır Sıva Tamir Harcı Kalın Tamir Harcı 3-30 mm (Yüzey Düzeltme Harcı)

30 Kg Kraft torba

117.00 TL /

1 Kg

Pk

Çimento esaslı, yüksek yapışma özelliğini ve mekanik mukavemetini arttıran kimyasal katkıları ve bütünsel hareketini sağlayan elyaf donatılar içeren suya ve dona dayanıklı, 3 - 30 mm kalınlığında uygulanabilen yüzey düzeltme sıvası ve tamir harcıdır, iç ve dış ortam yatay ve düşey yüzeyler üzerindeki onarımı yapılacak boşluk, çatlak ve kot farkından kaynaklı yüzey düzeltme işlemlerinde kullanılır. Kullanım Yüzeyleri; Çimento esaslı sıva ve şaplar, beton plaklar, prefabrika ve tünel kalıp yapı elemanları, brüt beton, cotto, tuğla, bims ve gazbeton yüzeyler.

Jelprima Seramik Üzerine Yapıştırma Astarı

3.5 Kg - Turuncu

297.00 TL

15 Kg - Turuncu

675.00 TL

Sentetik reçine esaslı, dik yüzeylerde akmayacak derecede kıvamlı, yüksek yapışma mukavemeti ve yüzek direncine sahip, seramik üstüne seramik uygulaması için geliştirilmiş renkli astardır. Uygulama yüzeyleri: üstün performansı sayesinde iç ortamlarda çimento esaslı yüzeyler, ahşap plakalar, sırlı seramikler, mermer, doğal taş, sert karolar, asfalt ve boyalı yüzeyler üzerine uygulandığında yüzeyde sert ve pürüzlü bir film tabakası oluşturarak diğer kaplama malzemelerinin yüzeye çok daha iyi tutunmasını sağlar. -0.4-0.5 kg/m2 tüketim, 1-2 mm uygulama kalınlığı, +30C - +80C sıcaklık direnci, fırça ve rulo ile uygulama, ph:-8, +5C- +30C uygulama sıcaklığı



Derz Dolgu Malzemesi Silikonlu 1.8 mm

20 Kg - Gri - Bej

280.00 TL

20 Kg - Beyaz

235.00 TL

1 Kg

22.50 TL



Sıva Alçısı Saten

225.00 TL/Pk

22.50 TL/Kg



Sıva Alçısı Peritli

150.00 TL/Pk

15.00 TL/Kg



Kartonpiyer Alçı

150.00 TL/Pk

15.00 TL/Kg

Derz Alçısı

25 Kg

145.00 TL



Derz Dolgu Tüp

380 gr

55.00 TL

Duvar Kağıdı Tutkalı

500 gr

125.00 TL



Sututan (Su İzolasyon Malzemesi) AC-3500

3.5 Kg

315.- TL / Adet

20 Kg

1260.- TL / Adet

Temeller, çatılar, bodrum duvarları ve su tecridi gereken yatay ve düşey tüm sathlarda, her türlü malzeme üzerinden kolayca uygulanan bir izolasyon malzemesidir



Activo AC-5600 Brüt Beton Astarı

3.5 Kg - Beyaz

207.- TL / Pk

12 Kg - Beyaz

450.- TL / Pk



Toz Boya

Yeşil - Kırmızı - Mavi - Siyah - Kahverengi - Sarı

50.- TL

Gaz Yağı

0.5 Lt

95.- TL

0.750 ml

125.- TL

1 Lt

180.- TL

3 Lt

510.- TL



Sulu Kireç

5 Kg

75.- TL

İspirto

1 Lt

57.- TL



Sıvı Silikon

5 kg

27028

30 kg

27029

60 kg

27030



Sıva Filesi (1 top -50 mt)

75 gr
160 gr

28.- \$ / Top
35.- \$ / Top



Fiberglass Sineklik Teli

45.00 TL / m²



Parke Şiltesi

11.75 TL / m²



Stor Perde Aparatı Metal Dar Geniş

12.50 TL
12.50 TL



Stor Perde Aparatı Plastik Dar Geniş

10.00 TL
10.00 TL



Korniş Tekli 2'li 3'lü

27.50 TL / mt
38.00 TL / mt
43.00 TL / mt



Korniş Dönüş 2'li 3'lü

35.00 TL
42.00 TL



Korniş Ekleme Aparatı 3'lü

25.00 TL

Korniş Duvara Montaj Aparatı

34.00 TL

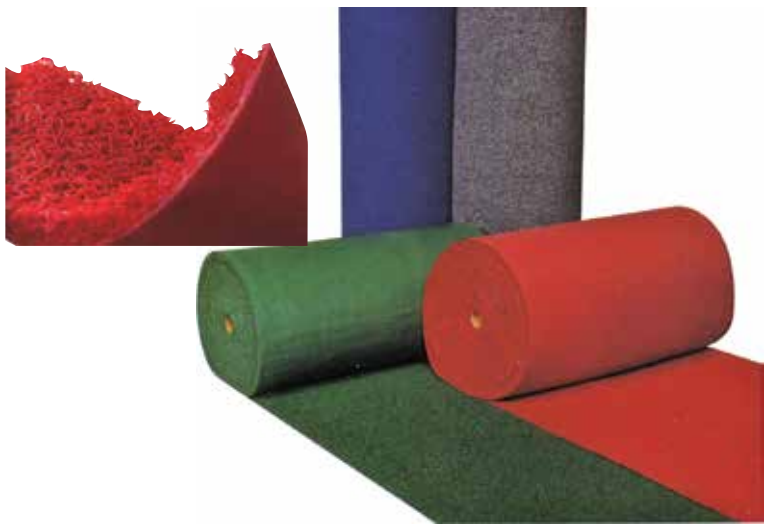

Kıvrıcık Paspas, Yoğun Trafik

12 mm kalınlık, 2.8 kg/mt
1mt x 20mt rulo, 7 renk seçeneği
Kırmızı, yeşil, mavi, siyah, gri, turuncu

325.- TL / m²

Kıvrıcık Paspas, Orta Trafik

14 mm kalınlık, 5.3 kg/mt
1mt x 15mt rulo, 7 renk seçeneği
Kırmızı, yeşil, mavi, siyah, gri

350.- TL / m²



Z Mat Paspas

Z Mat paspasları dayanıklı vinil çıkıntılarının birleşmesi ile hazırlanmıştır. Bu çıkıntılı çamuru ve nemi ayakkabılardan sökerken paspasın kaymamasını sağlar. Altı açık olmaması temizlik konusunda rahatlık sağlar. Kiri ve nemi alt kısımda biriktirmesi üst zeminin temiz ve kuru kalmasını sağlar. Vinil yapısı paspasın sıcaklıktan hasar görmesini engeller. Güneş ışığı ile temas ettiğinde rengi solmaz.

Z Mat Islak Zemin Paspası

9.50 \$ / m²

6 mm x 90 cm
6 mm x 120 cm

15 metrelik top halinde sevk edilir. İstenilen boylarda kesilir. Kırmızı, Gri, Yeşil, Siyah, Sarı, Mavi, Turuncu renk ile 7 farklı renk seçeneği



Alüminyum Kapı Altı Fırçası H Tip

100 cm

88.00 TL



Alüminyum Kapı Altı Fırçası T Tip

100 cm

88.00 TL



Kapı Altı Fırçası PVC Kendinden Yapışkanlı

100 c4

107.00 TL

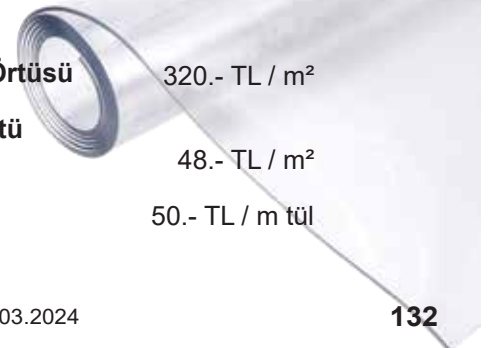

Kalın PVC Masa Örtüsü

320.- TL / m²

Kaymaz Şeffaf Örtü 50 cm en

48.- TL / m²

Masa Muşambası 140 cm en

50.- TL / m tül

Ağır Yük Dübeli
8x100mm (Vidasız)
10x100mm (Vidasız)
100 Adet/Paket



Adet
1.20 TL
2.35 TL

Bina İçi Gaz Beton Dübeli
8 mm (100 Adet) 41645
10 mm (100 Adet) 41646



Adet
2.05 TL
2.15 TL

Gözenekli beton için özel üretilmiş bir dübeştir. Spiral şeklinde ters açılı yapısı ile uygun basınç dağılımı yaparak gözenekli betonda yüksek taşıma değeri sağlar. Bina içi gaz beton dübeli, delik çapının iki katı oranında tutunma yeteneğine sahip olduğu için malzeme üzerinde bir bağlantı sağlar. Çakılma sırasında çatlamaz ve kırılmaz.

Turbolet Alçıpan Dübeli
Matkap Uçlu
13x33mm - 250 Adet/Paket



Adet
1.00 TL

Turbolet Alçıpan Dübeli
Düz Uçlu
12x28mm - 250 Adet/Paket



Adet
1.10 TL

Ağaç ve alçıpan yüzeylerde kullanılan bir dübeştir. Alçıpan kaplı yüzeylerde tablo, korniş, elektrik düğmeleri, lamba ve benzeri ürünlerin en kolay şekilde montajını sağlar. Montajı son derece pratiktir.



Tuğla Boşluk Dübeli
8 mm (500 Adet) 41605
10 mm (500 Adet) 41607

Adet
0.60 TL
0.80 TL



Roket Dübeli
8 mm (Sarı - 500 Adet) 41369
10 mm (Sarı - 500 Adet) 76014

Adet
0.50 TL
1.05 TL



Geniş Başlıklı Mantolama Dübeli
Ø60x10x100 mm - Siyah 500 Adet/Paket

Adet
1.75 TL

Taşıyıcı zemine ankraj boyu 50mm, matkap çapı 10 mm, pul çapı 60 mm, tüketim ısı yalıtım sistemleri ile 1m² için yaklaşık 6 adet



Plastik Paspayı Elemanı,
Norm Tipi
25mm (8-24mm) - 900 Adet/Paket
50mm (8-24mm) - 1000 Adet/Paket

Adet
1.15 TL
2.40 TL

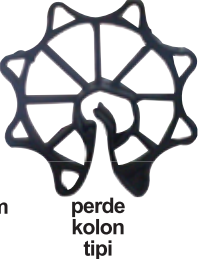

Perde Kolon Tipi
25mm (4-16mm) - 2500 Adet/Paket

Adet
0.80 TL

Perde Döşeme Tipi
25mm (6-18mm) - 2000 Adet/Paket

Adet
2.20 TL

ÖZİPEKLİLER

TEKNİK HIRDAVAT - ÇELİK TİCARET VE SAN. A.Ş. 01.05.2024

Saç Alçıpan Dübeli - Kısa Tip
11x28 mm
Saç Alçıpan Dübeli - Uzun Tip
11x40 mm

Adet
2.80 TL
3.70 TL



Delme yapılmaz. Kolay uygulanır. Çekiçle çakılır. 4 mm sunta vidası sıkılarak montaj yapılır. Perde, ayna, raf, havluluk, resim çerçevesi gibi eşyaların alçıpan yüzeylerin montajında kullanılır. Dikeyde 15 kg, yatayda 30 kg taşıma kapasitelidir.

Metal Alçıpan Paraşüt Korniş Dübeli
6 mm 4x46 mm

Adet
13.50 TL



Kalibre Alçıpan Dübel
8 mm (100 Adet)

Adet
0.65 TL



Kalibre Alçıpan Dübel Takım
Pul Başlı (100 Adet/Paket)

150.00 TL



Kalibre Alçıpan Dübel Takım
Bombe Başlı Pullu (100 Adet/Paket)

170.00 TL



Kanatlı Alçıpan Dübel
2 mm 500 Adet/Paket
3 mm 500 Adet/Paket

Adet
1.00 TL
1.10 TL

Alçıpan duvar, ahşap ve benzeri duvar bağlantılarında kullanılmak üzere tasarlanmıştır. Özel kanat ile uygulandığı yüzeyde emniyetli bir bağlantı yapar. Ancak emniyetli bağlantı için uygun booyda vida ile kullanılmalı ve uygulanacak yüzey kalınlığı ile dübel boyu uygun olmalıdır.

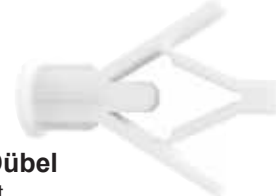

Plastik Dübel

6 mm (Beyaz - 1000 Adet) 41616 0.195 TL
7 mm (Beyaz - 1000 Adet) 41617 0.200 TL
8 mm (Beyaz - 1000 Adet) 41618 0.220 TL
10 mm (Beyaz - 500 Adet) 41620 0.450 TL
12 mm (Beyaz - 500 Adet) 41622 1.150 TL
14 mm (Beyaz - 250 Adet) 41624 2.250 TL



Mega Dübel
(korniş takma için pratik dübel)
8 mm - 500 Adet/Paket

Adet
0.60 TL

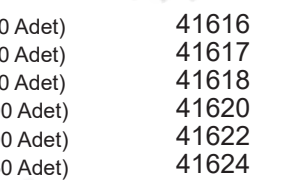

Çivili Dübel
500 Adet/Paket

Adet
0.80 TL





Saç Alçıpan Dübeli - Kısa Tip
11x28 mm
Saç Alçıpan Dübeli - Uzun Tip
11x40 mm

10'lu Paket
42.00 TL

60.00 TL



Turbolet Alçıpan Dübeli Matkap Uçlu
13x33mm
Turbolet Alçıpan Dübeli Düz Uçlu
12x28mm

10'lu Paket
6.00 TL

8.25 TL



Plastik Dübel
6 mm
7 mm
8 mm
10 mm
12 mm
14 mm

10'lu Paket
3.75 TL
3.75 TL
3.75 TL
6.00 TL
6.00 TL
18.75 TL



Tuğla Boşluk Dübeli
8 mm
10 mm

10'lu Paket
6.00 TL
8.25 TL



Çivili Dübel
Kanatlı Alçıpan Dübel

10'lu Paket
8.25 TL
12.00 TL



Roket Dübel
8 mm
10 mm

10'lu Paket
6.00 TL
8.25 TL



Sunta Vidaları (DIN 7505)

3.5x 13 mm
3.5x 16 mm
3.5x 20 mm
3.5x 30 mm
3.5x 40 mm
3.5x 50 mm
4.0x 20 mm
4.0x 30 mm
4.0x 40 mm
4.0x 50 mm
4.0x 60 mm
4.0x 70 mm
5.0x 30 mm
5.0x 40 mm
5.0x 50 mm
5.0x 60 mm
5.0x 70 mm
5.0x 80 mm
5.0x 100 mm
6.0x 50 mm
6.0x 60 mm
6.0x 70 mm
6.0x 80 mm
6.0x 100 mm
6.0x 120 mm

10'lu Paket

5.40 TL
6.60 TL
6.10 TL
8.50 TL
9.15 TL
10.50 TL
8.10 TL
10.50 TL
13.50 TL
15.90 TL
19.80 TL
22.20 TL
17.10 TL
23.10 TL
9.90 TL
29.40 TL
33.60 TL
42.60 TL
56.10 TL
38.70 TL
45.00 TL
51.60 TL
56.40 TL
75.30 TL
90.90 TL



Küçük S Kanca
Büyük S Kanca

3'lü Paket
11.48 TL
16.45 TL



Halkalı Vida

M 6
M 8
M 10

Halkalı Civata

M 6
M 8
M 10

Halka

No: 16
No: 20

3'lü Paket

91.00 TL
121.50 TL
170.50 TL

3'lü Paket

97.20 TL
105.70 TL
176.15 TL

3'lü Paket

27.90 TL
36.45 TL



Piton Vida

19x70
21x100
22x130
23x150
24x175

3'lü Paket

9.67 TL
12.83 TL
17.10 TL
21.24 TL
23.63 TL



NP1, İzolasyon ve Tamir Kimyasalı 4.75 €
290 ml, gri, siyah, terracotta, krem, beyaz, vizon, şeffaf, redwood
290 ml, Kristal 7.40 €



NP1, İzolasyon Sosis 9.50 €
600 ml, gri, siyah, beyaz



NP1 Automotive Sosis 11.50 €
600 ml, gri, siyah



Memento Kimyasal Dübel
300 ml 6.50 €
345 ml 8.20 €
410 ml 8.65 €

Maychem Kimyasal Dübel
300 ml 5.20 \$
345 ml 5.20 \$
410 ml 6.00 \$



Sedef Kimyasal Dübel 4.00 \$
345 ml



MAY 900 Poliüretan Köpük Memofom 3.58 €
600 gr

MAY 910 Poliüretan Köpük Memofom 5.00 €
750 ml, tabanlı model

TYTAN Polyfix 600 Poliüretan Köpük 3.30 €
600 gr



MAY 605 Memosil Silikon Kartuş
280 gr, Şeffaf 10010 2.10 €
280 gr, Beyaz 10011 2.10 €
280 gr, Kahverengi 2.10 €
280 gr, Gri 10012 2.10 €
280 gr, Siyah 10013 2.10 €

MAY 702 Silikonize Mastik Kartuş 1.10 €
500 gr, 23811 Beyaz

MAY 705 Memoakrilik Mastik Kartuş 1.05 €
310 ml, Beyaz, Gri, Siyah, Kahverengi



MAY 620 RTV Yüksek Isı Silikonu 4.10 €
310 ml, kırmızı
Yüksek ısıya mukavemetin gerektiği contalama, yapıştırma ve tamir işleri için geliştirilmiştir.

MAY 804 Naturel Silikon, Antibakteriyel
280 ml, şeffaf 3.60 €
280 ml, beyaz 3.60 €



MAY 600 PU Sıvı Çivi 5.05 €
300 ml, şeffaf



MAY 800 MDF Yapıştırıcı Kit
50 gr + 200 ml Koli Adedi : 50 2.40 €
100 gr + 400 ml Koli Adedi : 25 4.15 €

MAY 920 Deniz Tutkalı 4.65 €
550 gr / 600 ml 10065

POLİKOR**Supersoft Polyester Macun**

0.450 Kg (Oto)	8 Adet	5.25 \$
1.800 Kg (Oto)	8 Adet	11.95 \$
2.700 Kg (Oto)	8 Adet	14.85 \$

**POLY PUTY Polyester Macun**

0.450 Kg 1/2 (Oto)	3.30 \$
0.900 Kg 1/1 (Oto)	5.25 \$
1.800 Kg 2/1 (Oto)	7.60 \$
2.700 Kg 3/1 (Oto)	9.10 \$

**Poly Max Polyester Macun Sarı**

2.50 Kg brüt 3/1 (Oto)

**POLİKOR Politherm Isıya Dayanıklı Polyester Macun**

1.850 Kg 25.50 \$

**POLİKOR Super Polyester Macun**

1.85 Kg (Makina)	8 Adet	11.95 \$
3.60 Kg (Makina)	4 Adet	21.25 \$

Poly Puty Polyester Macun Gri

1.80 Kg 3/1 (Makina)	7.60 \$
4.20 Kg 4/1 (Makina)	13.70 \$

**POLİKOR Polilver Alüminyum Polyester Macun**

1.85 Kg 8 Adet 20.60 \$

**POLİKOR İnce Pasta**

200 ml Tüp	5.52 \$
0.5 Kg 12 Adet	11.05 \$
1 Kg 8 Adet	19.95 \$

**POLİKOR Oto Polish**

250 ml 12Adet	7.15 \$
1 Lt 12 Adet	19.90 \$

**Difix Doğalgaz Macunu**

Tüp - 50 gr	28.00 TL
Teneke - 400 gr	70.00 TL

**Difix Gres Yağı**

Küçük - 200 gr	160.00 TL
Büyük - 1000 gr	190.00 TL
Teneke - 14 kg	2000.00 TL
Tüp Gres - 50 gr	29.00 TL

**Grafix Mermer Yapıştırıcı Bej**

0.25 kg	2.60 \$
0.50 kg	3.15 \$
1.00 kg	4.30 \$
1.20 kg	4.45 \$

**Mermer Yapıştırıcı**

250 gr, Bej
1.23 kg, Beyaz
1.23 kg, Siyah
1.23 kg, Bej
25.5 kg, Beyaz
25.5 kg, Bej

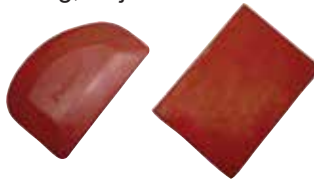
**Kauçuk Oto Macun Lastiği**

Oval	2.47 \$
Düz Kırmızı	2.20 \$

**Plastik Macun Uygulama Spatula****Zımpara Takoğu**

Büyük	6.60 \$
Orta	3.95 \$

**Difix Altın Yıldız Boya**

100 gr	82.00 TL
200 gr	110.00 TL

Difix Alüminyum Yıldız Boya

100 gr	54.00 TL
200 gr	90.00 TL

Difix Bakır Yıldız Boya

100 gr	90.00 TL
200 gr	120.00 TL

**Difix Toz Boya, Sim Boya**

20 gr - Altın	15.00 TL
20 gr - Gümüş	15.00 TL

**Ahşap Tutkalı**

100 gr	16.00 TL
700 gr	75.00 TL

**Difix Lavabo Açma Teli**

3 mt	120.00 TL
5 mt	145.00 TL
8 mt	180.00 TL

**Difix Makine Yağı**

50 cc 10.00 TL

**Difix Cam Macunu**

1 kg paket 75.00 TL

**Lavabo Açıcı**

Difix KAR YAK Baca Temizleyici 8.00 TL

**Pass WC Lavabo Açıcı**

1 kg 65.00 TL

Pass Harç Kum Eritici

1 kg 90.00 TL

Mitreapel PF321
Pipetli Poliüretan Köpük
750 ml, 600 gr



4.50 €

Mitreapel GM700
Yüksek Isı Silikonu
310 ml



5.40 €

Mitreapel PA300 Marin Tutkalı
600 ml, 550 gr



6.45 €

Mitreapel PF310 Poliüretan Köpük
750 ml, 850 gr



6.60 €

Mitreapel PF311
Tabancalı Poliüretan Köpük
750 ml, 850 gr

6.60 €

Mercury MF321
Pipetli Poliüretan Köpük
750 ml, 600 gr

4.50 €

Mitreapel PF370
Kapı ve Pencere Köpüğü
(Şişmeyen Köpük)
750 ml, 850 gr

6.98 €



Mitreapel TA300
PU Köpük Temizlevici
500 ml

3.60 €



Mitreapel Genel Amaçlı Silikon
280 ml, 320 gr,
SS700, Şeffaf 3.10 €
SS710, Beyaz 3.10 €
SS720, Siyah 3.10 €

Mitreapel Genel Amaçlı Silikon
250 ml, 280 gr,
SS701, Şeffaf 2.78 €
SS711, Beyaz 2.78 €
SS721, Siyah 2.78 €
SS731, Gri 2.78 €
SS741, Kahverengi 2.78 €
SS751, Bej 2.78 €



Mitreapel PU Sosis Mastik
600 ml,
PM400S, Beyaz 9.45 €
PM410S, Gri 9.45 €
PM420S, Siyah 9.45 €

Mitreapel SC700
Duşakabin Silikonu
280 ml, Şeffaf



4.35 €

Mitreapel SC710
Duşakabin Silikonu
280 ml, Beyaz

4.35 €



Mitreapel AS700
Akvaryum Silikonu
310 ml

5.10 €

Mitreapel MG700
Ayna ve Cam Yapıştırıcı
290 ml, Beyaz

6.90 €

Mitreapel MG740
Ayna ve Cam Yapıştırıcı
290 ml, Şeffaf

7.20 €

Mitreapel AS55
Silikonize Akrilik Mastik
500 gr, Beyaz 1.50 €
500 gr, Siyah 1.50 €
500 gr, Kahverengi 1.50 €
500 gr, Altın Meşe 1.50 €
500 gr, Gri 1.50 €
500 gr, Selvi 1.50 €
500 gr, Krem 1.50 €

Mitreapel AS50
Akrilik Boyanabilir Mastik
500 gr, Beyaz 1.48 €



Mitreapel WG206 Katkı Tutkalı
750 gr tüp 3.40 €

Mitreapel H660
Proseries High Tack Hibrit Yapıştırıcı
290 ml



7.50 €

Mitreapel MK 300 PU Sıvı Çivi
390 gr



6.15 €

Mitreapel WG150 MDF Profil Tutkalı
700 ml, 600 gr



3.30 \$

Mitreapel Hızlı Yapıştırıcı Kit
CA25 + AC100, 25 gr + 100 ml 2.18 €
CA50 + AC200, 250gr + 200 ml 3.00 €
CA100 + AC400, 100 gr + 400 ml 4.73 €



Mitreapel Hızlı Yapıştırıcı Kit
CA100 Tek Komponent 100 gr 3.15 €

Mitreapel Flex Hızlı Yapıştırıcı Kit
FC50 + FA200, 50 gr + 200 ml 2.77 €
FC100 + FA400, 100gr + 400 ml 4.20 €
FC125 + FA500, 125 gr + 500 ml 4.80 €





Alcon Hyper-RTV Nötr Sıvı Conta
Kırmızı, 90 gr M-3303 4.20 €
Siyah, 90 gr M-3304 4.20 €
Gri, 90 gr M-3308 4.20 €

Alcon Hyper-RTV Nötr Sıvı Conta
Kırmızı, 50 ml M-3302 2.48 €
Siyah, 50 ml M-3315 2.48 €



Alcon World Asetoksi RTV Sıvı Conta
Kırmızı, 50 ml M-3332 1.87 €
Siyah, 50 ml M-3331 1.87 €



Alcon World Asetoksi RTV Otomatik Sıvı Conta
Siyah, 50 ml M-3336 13.80 €
Gri, 50 ml M-3337 13.80 €
Kırmızı, 50 ml M-3338 13.80 €



Alcon Jellock Orange Sıvı Conta
50 ml M-3330 7.51 €



Alcon Şeffaf Silikon
Tüp, 40 ml M-5506 1.76 €



Alcon İzolasyon Sprey
Kırmızı, 400 ml M-9011 4.84 €
Şeffaf, 400 ml M-9012 4.84 €

Alcon Duman Dedektör Sprey
200 ml M-9008 6.67 €



Alcon AL-690 Yüzey Temizleyici Sprey
500 ml M-7727 7.36 €

Alcon AL-680 Kırmızı Nüfuz Edici Sprey
500 ml M-7726 10.20 €

Alcon AL-700 Çatlak Belirleyici Sprey
500 ml M-7728 9.20 €



Alcon Tampon Tamir Kiti
1000 gr M-2211 52.37 €



Alcon Shellock Kuvvetli Conta Yapıştırıcı
50 ml M-9904 7.13 €



Alcon Rapid Plastik Çelik 5 Dakika
16 gr M-2205 2.68 €



Alcon Özel Plastik Çelik Reçine
4.5 kg M-8801 224.00 €

Alcon Özel Plastik Çelik Katalizör
3 kg M-8803 149.50 €



Alcon Özel Plastik Çelik Endüvi Verniği
1000 gr kutu M-8814 52.30 €



Alcon Pro-Mix Epoksi Macun
40 gr M-2217 3.52 €
80 gr M-2207 6.36 €



Alcon Aqua Mix Bond
57 gr M-2239 4.28 €



Alcon Alcobond Cam Bandı
35mm x 100mt M-2232 24.53 €
50mm x 100mt M-2233 35.27 €



Alcon Epoksi Metalik Yapıştırıcı
30 gr mikserli şırıngalı M-2312 4.44 €



Alcon Epoksi Şeffaf Yapıştırıcı
30 gr mikserli şırıngalı M-2313 4.37 €



Alcon Metalize Plastik Çelik Yapıştırıcı
100 gr M-2220 11.96 €
500 gr M-2221 46.77 €



Alcon (A) Putty Metal Bond
500 gr M-2222 76.68 €



Alcon (B) Liquid Metal Bond
500 gr M-2226 92.00 €
Epoksi reçine ve çelik toz karışımı



Alcon Plastic Metal Bond (WR)
Wear Resistant Epoksi Macun
500 gr M-2235 227.00 €



ALCON
INDUSTRIAL

Alcon Prusya Mavisı
Teknik Test Macunu
40 gr M-9804 13.80 €



Alcon Plastic Metal Bond (BR)
Putty Bronze Bond
500 gr M-2223 138.00 €
Epoksi reçine ve bronz toz karışımı



Alcon Alsona 7111 Plastik
Epoksi ve Metal Karışım
1000 gr M-7111 230.00 €



Alcon Su Seviye Tespit Macunu
85 gr M-9811 10.15 €

Alcon Yakıt Seviye Tespit Macunu
75 ml M-9812 11.00 €

Alcon Plastic Metal Bond (F)
Putty Aluminium Bond
500 gr M-2224 115.00 €



Alcon Alcobond Epoksi Yama
455 gr M-2229 76.70 €



Alcon Rulman Gresli Multi Lube WR2
1000 gr M-9810 33.75 €



Alcon Plastic Metal Bond (F-2)
Epoxy Liquid Aluminium Bond
500 gr M-2225 115.00 €



Epoksi Döküm Tipi Reçine
1.6 kg 25.35 € / Takım

Alcon Coppersolid Otomatik
Bakırlı Montaj Pastası
500 gr kutu M-9800 31.30 €
90 ml tüp M-9801 9.50 €



Alcon Plastic Metal Bond (SF)
5 Dakika Epoksi Macun
500 gr M-2228 107.30 €



Alcon Sızıntı Giderici Sprey
400 ml
Beyaz M-9014 8.97 €
Siyah M-9015 8.97 €

Alcon Metal Polish
(Çok Amaçlı Metal Parlatici)
80 gr tüp M-9935 4.68 €



Alcon Plastic Metal Bond (TI)
Titanium Epoksi Macun
500 gr M-2234 168.70 €



Alcon AL-94
Cuttingtap Kesme Sıvısı
250 ml M-9809 9.66 €
500 ml M-9803 17.63 €
4 lt bidon M-9805 130.35 €



Alcon Constar Toz Çatlak İlacı
20 gr poşet M-9909 1.61 €

Alcon Silvery Toz Çatlak İlacı
3/4 oz kutu M-9906 1.76 €



Alcon Plastic Metal Bond (ST)
Paslanmaz Çelik Epoksi Macun
500 gr M-2227 118.00 €



Alcon Subap Alıştırma Macunu
250 gr
No : 40 - 60 - 80 - 100 30.00 €
No : 120 - 150 - 180 - 220 36.35 €
No: 280 - 400 - 600 41.85 €
No : 800 - 1200 41.85 €

Marker Ball (İşaretleme Kalem)
50 ml tüp
Beyaz M-3340 4.45 €
Sarı M-3344 4.45 €
Kırmızı M-3345 4.45 €



Sibax NS 13
Poliüretan Dolgu Köpüğü
300 ml 1.85 €



Sibax NS 66
Poliüretan Dolgu Köpüğü
600 gr, Gri 2.50 €



Sibax NS 72
Poliüretan Mega Tabancalı Köpük
1000 gr 5.60 €

Sibax NS 88
Poliüretan Tabancalı Köpük
750 ml 3.85 €

Sibax NS 82
Poliüretan Yangına Dayanıklı Köpük
900 gr (TSE Uygun) 7.15 €



Sibax NS 99
Poliüretan Mantolama Köpüğü
900 gr 4.70 €



Sibax NS 99T
Poliüretan Tabancalı
Mantolama Köpüğü
900 gr 4.75 €

Sibax NS 22
Poliüretan Köpük Temizleyici
500 ml 3.85 €



Sibax LS 10
Duşakabin Silikonu
310 ml, Şeffaf 3.20 €
310 ml, Beyaz 3.20 €



Sibax LS 22
Nötr Ayna Silikonu
280 ml, Şeffaf 3.35 €



Sibax LS 30
Akvaryum Silikonu
280 ml, Şeffaf 2.60 €



Sibax LS 66
Universal Silikon
280 gr, Şeffaf 1.55 €
280 gr, Beyaz 1.55 €
280 gr, Siyah 1.70 €
280 gr, Kahverengi 1.70 €
280 gr, Gri 1.70 €
280 gr, Antrasit 1.70 €



Sibax LS 99
Asetoksi Yüksek Isı Silikonu
280 ml, Kırmızı 2.90 €



Sibax WS 55
Oto Cam Yapıştırıcı
280 ml, Siyah 2.85 €
600 ml, Siyah 5.45 €



Sibax LS 65
Üniversal Silikon
40 ml, Şeffaf 0.75 €



Sibax NS 78
High Tack
Korniş Montaj Yapıştırıcı
290 ml, Beyaz 3.95 €



Sibax LS 44
Akrilik Mastik
475 gr, Beyaz 0.70 €
475 gr, Gri 0.75 €
475 gr, Siyah 0.75 €
475 gr, Kahverengi 0.75 €



Sibax NS 44
Anber Deniz Tutkalı
500 gr 3.45 €



Sibax NS 68
Akrilik Sıvı Çivi
280 ml 3.95 €



Sibax BS 12
Hızlı Yapıştırıcı Mdf Kit
200 ml + 50 gr 1.80 €
400 ml + 100 gr 3.20 €



Auto Kit FA1 - 089
Klima ve Hava Temizleyici
150 ml 105.00 TL



Auto Kit FA1 - 153
Kurşunsuz Benzin Enjektör Temizleyici
250 ml 88.00 TL

Auto Kit FA1 - 154
Dizel Yakıt Katkısı
250 ml 88.00 TL

Auto Kit FA1 - 155
Dizel Enjektör Temizleyici
250 ml 88.00 TL



Auto Kit FA1 - 199
Magic Dose Bor Dizel Enjektör Temizleyici
250 ml 97.00 TL

Auto Kit FA1 - 200
Magic Dose Bor Benzin Enjektör Temizleyici
250 ml 97.00 TL



Auto Kit FA1 - 300
Magic Dose Radyatör Sızıntı Temizleyici
250 ml 57.00 TL

Auto Kit FA1 - 301
Magic Dose Radyatör Temizleme
250 ml 57.00 TL

Auto Kit FA1 - 303
Duman Ömleyici Yağ Katkısı
250 ml 115.00 TL



Auto Kit
Torpido Parlatici, 400 ml
FA - 708 Ocean 140.00 TL
FA - 709 Mango 140.00 TL
FA - 707 Vanilya 140.00 TL
FA - 706 New Car 140.00 TL



Auto Kit FA1 - 187
Oto İç Cila Torpido Yemileme Koruma Sütü
500 ml 100.00 TL

Auto Kit FA1 - 210
Motor Temizleyici
500 ml 100.00 TL



Auto Kit FA1 - 230
Lastik Tamir Kiti
500 ml 144.00 TL



Auto Kit
Oto İç Cila
FA1 - 268 Vanilya 57.00 TL
FA1 - 269 New Car 57.00 TL



Auto Kit FA1 - 185
Genel Temizleyici Sprey
500 ml 73.00 TL

Auto Kit FA1 - 142
Magic Dose Silikonlu Genel Temizleme
750 ml 63.00 TL



Auto Kit FA1 - 211
Jant Temizleme
500 ml 66.00 TL

Auto Kit FA1 - 212
Zift Temizleme
500 ml 125.00 TL



Auto Kit FA1 - 213
Lastik Temizleme ve Parlatma
500 ml 75.00 TL

Auto Kit FA1 - 227
Hızlı Cila
500 ml 100.00 TL



Auto Kit FA1 - 228
Pasta Cila Set 2 Süngerli
300 gr 100.00 TL



Auto Kit FA1 - 232
Çizik Alıcı Pasta Cila Eko
300 gr 74.00 TL

Auto Kit FA1 - 233
Pasta Cila
300 gr 74.00 TL



Auto Kit FA1 - 236
Döşeme Temizleyici Kokulu
500 ml 70.00 TL

Auto Kit FA1 - 237
Torpido Bakım Sütü
500 ml 70.00 TL



**Auto Kit
Magic Dose Dekoratif Küre Koku
100 ml**

FA1 - 834 Odunsu	138.00 TL
FA1 - 833 Mango	138.00 TL
FA1 - 832 Okyanus	138.00 TL
FA1 - 831 Bubble Gum	138.00 TL



**Auto Kit
Magic Dose Multi Sprey Koku
500 ml**

FA1 - 194 Okyanus Esintisi	122.00 TL
FA1 - 195 İğde Çiçeği	122.00 TL
FA1 - 196 Kavun	122.00 TL
FA1 - 275 Kestane	122.00 TL
FA1 - 276 Aşk Endless	122.00 TL
FA1 - 277 Lavanta Lavender	122.00 TL



**Auto Kit
Magic Dose Multi Sprey Koku
350 ml**

FA1 - 360 Marina Okyanusu	92.00 TL
FA1 - 361 İğde Çiçeği	92.00 TL
FA1 - 362 Sonsuz Aşk	92.00 TL
FA1 - 363 Manolya	92.00 TL
FA1 - 364 Kır Çiçeği	92.00 TL
FA1 - 365 Yıldız	92.00 TL



**Auto Kit
Magic Dose İnci Koku**

FA1 - 382 Mango	82.00 TL
FA1 - 383 Vanilya	82.00 TL
FA1 - 366 Woody Odunsu	82.00 TL



**Auto Kit
Magic Dose Hava Temizleyici Jel Koku**

FA1 - 495 Mango	50.00 TL
FA1 - 496 Şeftali Kiraz	50.00 TL
FA1 - 497 Manolya	50.00 TL
FA1 - 498 Papatya	50.00 TL



**Auto Kit FA1 - 238
Çizik Alıcı Cila
300 ml 72.00 TL**

**Auto Kit FA1 - 288
Far Temizleme ve Parlatıcı
250 ml 116.00 TL**



**Auto Kit
Renkli Likit Cila, 300 ml**

FA1 - 262 Gri	74.00 TL
FA1 - 263 Kırmızı	74.00 TL
FA1 - 264 Siyah	74.00 TL
FA1 - 265 Beyaz	74.00 TL



**Auto Kit FA1 - 198
Magic Dose Bor Motor Yağı
250 ml 319.00 TL**



**Auto Kit FA1 - 271
Kokusuz Küllük 28.00 TL**

**Auto Kit FA1 - 272 63.00 TL
Desenli Cam Ünsel Küllük**

**Auto Kit FA1 - 282 20.00 TL
Kokusuz Renkli Küllük**



**Auto Kit FA1 - 567 42.00 TL
Fosforlu Lux Araç Numeratörü**

**Auto Kit FA1 - 999 25.00 TL
Kaza Tespit Tutanak Seti Kalemli**



**Auto Kit FA1 - 123
Buz Kazıyıcı 88.00 TL**



**Auto Kit FA1 - 163
Oto Cam Suyu 4 Mevsim
1 Lt 43.00 TL**

**Auto Kit FA1 - 148-B
Oto Cam Suyu
5 Lt 113.00 TL**



**Auto Kit FA1 - 305
Antifiriz Cam Buz Çözücü,
Solvent Ice 50.00 TL**

**Auto Kit FA1 - 309
Cam Buz Çözücü, Solvent Ice
500 ml 60.00 TL**

**Auto Kit FA1 - 308
Cam Yağmur Kaydırıcı
200 ml, Rain free 33.00 TL**

**Auto Kit FA1 - 304
Cam Buğu Önleyici
200 ml, Antifog 33.00 TL**



**Auto Kit FA1 - 502
Cam Çek Eko 20 cm 22.00 TL**



Auto Kit Silecek 9 Aparatlı

FA1 - 770 - 38 cm	150.00 TL
FA1 - 771 - 40 cm	150.00 TL
FA1 - 772 - 45 cm	150.00 TL
FA1 - 773 - 48 cm	150.00 TL
FA1 - 774 - 50 cm	150.00 TL
FA1 - 775 - 55 cm	150.00 TL
FA1 - 776 - 60 cm	150.00 TL
FA1 - 777 - 65 cm	150.00 TL
FA1 - 778 - 70 cm	150.00 TL

Auto Kit Universal Silecek

FA1 - 780 - 38 cm	88.00 TL
FA1 - 781 - 40 cm	88.00 TL
FA1 - 782 - 43 cm	88.00 TL
FA1 - 783 - 45 cm	88.00 TL
FA1 - 784 - 48 cm	88.00 TL
FA1 - 785 - 50 cm	88.00 TL
FA1 - 786 - 53 cm	88.00 TL
FA1 - 787 - 55 cm	88.00 TL
FA1 - 788 - 60 cm	88.00 TL
FA1 - 789 - 65 cm	88.00 TL
FA1 - 790 - 70 cm	88.00 TL



Auto Kit
Magic Dose Dekoratif Ayna Kokusu
10 ml

FA1 - 350 Mango	50.00 TL
FA1 - 351 Meyve Bahçesi	50.00 TL
FA1 - 352 Okyanus	50.00 TL
FA1 - 353 Sonsuz Aşk	50.00 TL
FA1 - 354 Odunsu	50.00 TL
FA1 - 355 Bubble Gum	50.00 TL



Auto Kit FA1 - 320
Limon Kolonyası
150 ml Sprey 53.00 TL



Auto Kit FA1 - 090
Extra Lüks Üstübü
150 gr 37.00 TL



Auto Kit FA1 - 136
Oto Yıkama Süngeri
Ekonomik 25.00 TL

Auto Kit FA1 - 137
Torpedo Parlatici Ultra
Sünger 16.00 TL



Auto Kit FA1 - 523
Mikrofiber Havlu Bez
50x70 cm 86.00 TL



Auto Kit FA1 - 820
Mikrofiber Sentetik
Temizleme Bezi
50x70 cm 113.00 TL

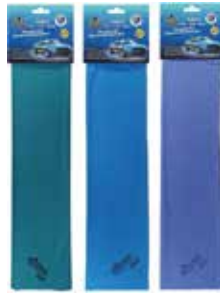

Auto Kit FA1 - 1187
Magic Dose Super
Oto Cam Bezi
50x60 cm 66.00 TL

Auto Kit FA1 - 886
Magic Temizlik Bezi
50x70 cm 73.00 TL



Auto Kit FA1 - 516
Mikrofiber Temizlik Bezi 4'lü
30x30 cm 56.00 TL

Auto Kit FA2 - 1259
Magic Dose
Yüzey Temizlik Havlusu 100'lü 114.00 TL



Auto Kit FA1 - 591
Jant Temizleme Köpüğü
500 ml 144.00 TL

Auto Kit FA1 - 592
Lastik Temizleme Köpüğü
500 ml 144.00 TL



Auto Kit FA1 - 597
Döşeme Temizleme Köpüğü
500 ml fırçalı 219.00 TL



Auto Kit FA1 - 234
Deri Vinil Koruyucu Seti 165.00 TL

Auto Kit FA1 - 306
2'li İç Bakım Seti Vakumlu 87.00 TL



Auto Kit FA1 - 143
Magic Dose Silikonlu Ünsel
Güçlü Temizleyici 1000 ml 88.00 TL



Auto Kit FA1 - 188
Cilalı Oto Şampuanı
1 Lt 85.00 TL

Auto Kit FA1 - 189
Oto Şampuanı Portakallı 74.00 TL



Auto Kit FA1 - 644
öncam Güneşlik Büyük Boy 92.00 TL



Auto Kit FA1 - 660
Dekoratif Çok Amaçlı
Kilim Minder 138.00 TL

Auto Kit FA1 - 661
Dekoratif Çok Amaçlı
Komple Kilim Minder 250.00 TL

Auto Kit FA1 - 662
Oto Kılıfı Kaptan 2'li 365.00 TL



Auto Kit FA1 - 1102
Araç Yastığı Karakter 84.00 TL



Auto Kit FA1 - 1103
Seyahat Boyun Yastığı 138.00 TL



Auto Kit FA1 - 1104
Araç Boyun Yastığı 100.00 TL



SOMOFİX SE600
Poliüretan Dolgu Köpüğü
600gr

2.42 €

SOMOFİX SE801
Poliüretan Dolgu Köpüğü
300ml 345gr

1.97 €



SOMOFİX S915
Poliüretan Mantolama Köpük
Tabancalı
750ml 940gr

4.70 €



SOMOFİX
Duşakabin Silikonu
280ml 320 gr
S230 - Şeffaf
S231 - Beyaz

2.99 €

2.99 €



SOMOFİX S911
Poliüretan Tabancalı Köpük
750ml 845gr

3.85 €



SOMOFİX S899
Poliüretan Köpük Temizleyici
500ml 430gr

2.14 €



SOMOFİX
Yapı İnşaat ve Dış Cephe Silikonu
310ml 355 gr
S370 - Şeffaf
S371 - Beyaz
S372 - Siyah

3.25 €

3.25 €

3.25 €



SOMOFİX S951
Poliüretan Mega Tabancalı Köpük
850ml 1000gr

4.62 €



SOMOFİX
Genel Amaçlı Silikon
280gr
SE280 - Şeffaf
SE281 - Beyaz
SE282 - Siyah
SE283 - Kahverengi
SE284 - Gri
SE289 - Antrasit

1.43 €

1.43 €

1.43 €

1.81 €

1.81 €

1.81 €



SOMOFİX S392
Cam Sızdırmazlık
Oto Cam Silikonu
Siyah 300ml 415gr

2.74 €



SOMOFİX S917
Poliüretan Yangına Dayanıklı
Tabancalı Köpük
750ml 900gr

5.38 €



SOMOFİX S815
Poliüretan Mantolama Köpük
750ml 920gr

4.62 €



SOMOFİX
Genel Amaçlı Tüp Silikon
50ml
S50 - Şeffaf
S51 - Beyaz

0.91 €

0.91 €



SOMOFİX
Ayna Silikonu
280ml 330 gr
S280 - Şeffaf
S281 - Beyaz
S282 - Siyah

3.08 €

3.08 €

3.08 €



SOMOFİX S85
Mum Silikon Şeffaf
11.3 x 300 mm, 1 kg

5.47 €



SOMOFİX S220
Akvaryum Silikonu
Şeffaf, 280ml 320gr

2.99 €



SOMOFİX S257
RTV Isı Silikonu Kırmızı
280ml 320gr

2.99 €



SOMOFİX SE450
Akırlık Mastık
45gr Beyaz

0.80 €



SOMOFİX
Akırlık Silikon ve Mastık
310ml 500gr
S121 - Beyaz
S122 - Siyah
S123 - Kahverengi
S124 - Gri
S128 - Antrasit

0.85 €
0.89 €
0.89 €
0.89 €
0.89 €



SOMAFİX S150P
Sıvı Çivi
310ml 400gr Şeffaf

3.16 €



SOMAFİX S160
Isı Mastığı 1500C
310ml 600gr Siyah

2.02 €



SOMAFİX S580
High Tack Korniş Yapıştırıcısı
280ml 480gr Beyaz

3.33 €



SOMAFİX
Poliüretan Mastık Kartuş
280ml 365gr
S421 - Beyaz
S422 - Siyah
S424 - Gri
S426 - Antrasit

2.91 €
2.91 €
2.91 €
2.91 €



SOMAFİX
Poliüretan Mastık Sosisi
600ml
S751 - Beyaz
S752 - Siyah
S754 - Gri
S757 - Antrasit

4.31 €
4.31 €
4.31 €
4.31 €



SOMAFİX
MDF Kit Hızlı Yapıştırıcısı
S663 - 200ml + 50gr
S665 - 400ml + 100gr

1.45 €
2.56 €



SOMAFİX SE700
Kimyasal Dübel
300ml

3.42 €



SOMAFİX S605
Deniz Tutkalı D4
500gr Amber

3.25 €



SOMAFİX S500
Deniz Tutkalı D3
550gr Beyaz

1.71 €



SOMOFİX S35
Fren Temizleme Spreyi
500ml 425gr
SOMOFİX S37
Sıvı Gres 500ml 420gr

1.62 €

2.22 €



SOMAFİX
Boru Sızdırmazlık
Orta Mukavemet Sökülebilir
S042 - 50gr Mavi
S042 - 250gr Mavi

2.90 €
9.40 €



SOMAFİX
Dış Sabitleyici
Orta Mukavemet
S043 - 50gr Mavi
S043 - 250gr Mavi

2.90 €
9.40 €



SOMAFİX
Dış Sabitleyici
Yüksek Mukavemet
S070 - 50gr Yeşil
S070 - 250gr Yeşil

2.90 €
9.40 €



SOMAFİX
Kenetleyici
Yüksek Mukavemet
S038 - 50gr Yeşil
S038 - 250gr Yeşil

2.90 €
9.40 €



SOMAFİX
Dış Sabitleyici
Düşük Mukavemet
S022 - 50gr Mor
S022 - 250gr Mor

2.90 €
9.40 €



EMS FORCE Civate Sabitleyiciler

TL-43, Orta Kuvvet Civate Sabitleyici

50 ml 5.13 \$
250 ml 12.35 \$

Yarıçapı 1/4" - 3/4" (6-20 mm) veya daha küçük olan, titreşim altında gevşeyen vida parçaları için idealdir. Yağ direnci geliştirilmiş çiviler ve vidalarda, somunların sabitlenmesi ve sızdırmazlıkların sağlanmasında kullanılır.

TL-70, Yüksek Kuvvet Civate Sabitleyici

50 ml 5.13 \$
250 ml 12.35 \$

Yarıçapı 1 (25 mm) olan bağlantı elemanları için uygundur. (Şanzıman ve motor bloğu saplamaları, vana setleri, vb.) Yüksek mukavemet gösterir, aynı zamanda ekstra somun ve kaynak kullanımı gerektirmez. Korozyonu ve sızıntıyı önler. Yağlı yüzeylerde mükemmel performans gösterir. Titreşim altındaki makine veya hareketli parçaların birleşiminde kullanılabilir.

RT-38, Çok Yüksek Kuvvet Rulman Sabitleyici

50 ml 5.13 \$
250 ml 12.35 \$

Oda sıcaklığında maksimum mukavemet istenen ve 0,25 mm (0,01") çapındaki boşlukları doldurmak için idealdir. Millerin ve gövdelerin üzerinde yuvalar ve burçları kilitlemek için uygundur. Mükemmel tutma, sızdırmazlık ve civataları sabitleme özelliğine sahiptir.

5542, Boru Sızdırmazlık Elemanı

50 ml 5.13 \$
250 ml 12.35 \$

Metal boru bağlantılarının kenetlenmesi ve sızdırmazlığı için idealdir. Orta mukavemetle sızdırmazlık özelliği ile düşük viskozitelidir.

5543, Boru Sızdırmazlık Elemanı Doğalgaz için

50 ml 5.13 \$
250 ml 12.35 \$

Metal boru bağlantılarının kenetlenmesi ve sızdırmazlığı için idealdir. Orta mukavemetle sızdırmazlık özelliği ile düşük viskozitelidir.

5577, Boru Sızdırmazlık Elemanı

50 ml 5.13 \$
250 ml 12.35 \$

Metal boru bağlantılarının kenetlenmesi ve sızdırmazlığı için idealdir. Orta mukavemetle sızdırmazlık özelliği ile düşük viskozitelidir.



Sellock Civate Sabitleyiciler

3641, Orta Mukavemetli Rulman Kenetleyici

50 gr 5.50 \$

Oda sıcaklığında maksimum mukavemet istenen ve 0,25 mm (0,01") çapındaki boşlukları doldurmak için idealdir. Millerin ve gövdelerin üzerinde yuvalar ve burçları kilitlemek için uygundur. Mükemmel tutma, sızdırmazlık ve civataları sabitleme özelliğine sahiptir.



LOCTITE Endüstriyel Yapıştırıcılar

638, Yüksek Mukavemetli Sıkı Geçme Bileşeni

50 ml 43.20 €
250 ml 169.- €

LOCTITE 638 yüksek mukavemetli, hızlı kürleşen, genel amaçlı bir sıkı geçme bileşenidir. LOCTITE 638, özellikle yapıştırma boşluklarının 0,25 mm'ye yaklaşabildiği durumlarda, silindirik parçaların yapıştırılması için tasarlanmıştır. Ürün, sıkı geçen metal yüzeyler arasında havasız kaldığında kürlenerek, şok ve titreşime bağlı gevşeme ve sızıntıları önler. Yalnızca aktif metallerde değil aynı zamanda pasif yüzeylerde de etkili olarak, iyi bir kürlenme performansı gösterir. Yüksek sıcaklık performansına ve güçlü yağ toleransına sahip ürün, hafif yüzey kirletici maddelere de tolerans gösterir.

620, Yüksek Sıcaklığa Dayanıklı Sıkı Geçme Bileşeni

50 ml 43.60 €
250 ml 169.- €

LOCTITE 620, yüksek mukavemetli, yüksek sıcaklığa dayanıklı bir sıkı geçme bileşenidir. LOCTITE 620, silindirik montaj parçalarının yapıştırılması için tasarlanmış bir sıkı geçme bileşenidir. Ürün, sıkı geçen metal yüzeyler arasında, hava olmaksızın kürenebilir ve şok ve titreşime bağlı gevşeme ve sızıntıları önler. Tipik uygulamaları arasında radyatör tertibatlarına pim, pompa muhafazalarına manşon ve şanzımanlara yatak yerleştirilmesi bulunmaktadır. Özellikle 200°C'ye kadar sıcaklık dayanımının gerektiği uygulamalar için uygundur.

270, Vida Sabitleyici

50 ml 39.75 €
250 ml 153.- €

Vida Gevşemezlik Ürünü- yüksek mukavemetli. Kalıcı kilitleme. Tüm metal dişli bağlantılara uygundur. LOCTITE 270 vibrasyon kaynaklı gevşemenin önlenmesi için, civata, somun ve saplamaları sağlamlaştırılması suretiyle sızdırmazlığını sağlanmasında maksimum etkinliğe yönelik yüksek mukavemetli bir vida gevşemezlik ürünüdür. Bu ürün, gevşememesi gereken tertibatların kalıcı olarak kilitletmesini sağlar. Paslanmaz çelik, alüminyum ve kaplamalı yüzeyler gibi pasif yüzeyler dahil tüm metallerde etkilidir. Motor yağları, korozyon önleyici yağlar ve kesme sıvıları gibi endüstriyel yağlardan kaynaklanan az miktardaki yüzey kirliliğine karşı dayanıklı olduğu kanıtlanmıştır. 300°C'ye kadar ısıtılarak sökülebilir.

243, Vida Sabitleyici

50 ml 39.75 €
250 ml 153.- €

LOCTITE 243, darbe ve titreşimden dolayı gevşemelerini önlemek için somunları ve civataları sızdırmaz hale getiren ve sabitleyen orta mukavemetli mavi bir vida gevşemezlik ürünüdür. LOCTITE 243, orta mukavemetli bir sabitleme sağlayan genel amaçlı bir vida sabitleyicidir. LOCTITE 243 paslanmaz çelik, alüminyum ve kaplama yüzeyler gibi pasif yüzeyler dahil tüm metallerde etkilidir. Motor yağları, korozyon önleyici yağlar ve kesme sıvıları gibi endüstriyel yağlardan kaynaklanan az miktardaki kontaminasyona karşı dayanıklı olduğu kanıtlanmıştır.

222, Vida Sabitleyici

50 ml 40.00 €

Vida Gevşemezlik Yapıştırıcısı - düşük mukavemetli. Kolay sökülebilir. Tüm metal dişli bağlantılara uygundur. LOCTITE 222, gömme başlı ve tespit vidaları da dahil, ayar yapılmasına olanak veren düşük mukavemetli bir vida gevşemezlik ürünüdür. Alüminyum veya pirinç gibi, sökülürken kırılabilecek düşük mukavemetli metallerde kullanışlıdır. Paslanmaz çelik, alüminyum ve kaplamalı yüzeyler gibi pasif yüzeyler de dahil tüm metallerde etkilidir. Motor yağları, korozyon önleyici yağlar ve kesme sıvıları gibi endüstriyel yağlardan kaynaklanan az miktardaki yüzey kirliliğine karşı dayanıklı olduğu kanıtlanmıştır.



JELLY MIX

Partiküllü El Temizleme Kremi

4 kg	775.45 TL
1/2 kg krem	130.65 TL
1/2 kg sıkma	125.50 TL
1 kg pompasız	200.00 TL
10 kg	1660.00 TL
15 kg	2130.00 TL



W-DO Torpido Parlatici

0.4	145.00 TL
1 kg	305.00 TL



W-STICK

Bant ve Yapışkan Sökücü

370.00 TL



WİPE SOL Özel Yağ Çözücü

1 kg sprey	195.00 TL
5 kg	764.00 TL
30 kg	3966.00 TL



MTR Clean Motor Temizleyici

0.4	115.00 TL
-----	-----------



W-GUMMI Lastik Parlatici

0.4	120.00 TL
-----	-----------



WİPE TIME Ağır Kir ve Yağ Çözücü

1 kg sprey	185.00 TL
5 kg	715.00 TL
30 kg	3675.00 TL



W-WASH

Fırçasız Oto Yıkama Köpüğü

1 kg	86.00 TL
5 kg	396.00 TL
30 kg	1875.00 TL



WİPE SHINE

WC tuvalet Fayans Temizleyici

1 kg	140.00 TL
5 kg	520.00 TL
30 kg	3300.00 TL



WİPE MIX

Çok Amaçlı Genel Temizlik

1 kg	210.00 TL
5 kg	810.00 TL
30 kg	4180.00 TL



W-Piramit Jant Temizleyici

0.4	130.00 TL
1 kg	215.00 TL



HARD POWER

Beton, Harç Çözücü

1 kg	115.00 TL
5 kg	405.00 TL
30 kg	1800.00 TL

**MXS Fren Balata Temizleme Sprey**

500 ml, 445gr, 335 gr net 2.22 \$
Klor içermez. Fren sisteminde yer alan kalıplar, balatalar, diskler, kampanalar, fren merkez silindiri, mungeneler, yaylar ve debriyaj parçalarını temizler, aynı zamanda tutma özelliğini artırır.

COLORIUM Fren Balata Sprey

500 ml, 420 gr, 310 gr net 1.80 \$
standart formül

HELPER

Fren Balata Sprey 1.69 \$
500 ml, 360 gr, 270 gr net

MXS Etiket Sökücü Sprey

200 ml, 175gr, 115 gr net 3.38 \$
400 ml, 330 gr, 230 gr net 6.26 \$

MXS

Güçlü Yapıştırıcı Sprey 3.86 \$
500 ml, 420 gr, 310 gr net



MXS Paslanmaz Inox Sprey 4.47 \$
400 ml, 380 gr, 280 gr net

MXS Galvaniz Çinko Sprey 4.92 \$
400 ml, 380 gr, 280 gr net

MXS Gold Efekt Sprey 5.00 \$
400 ml, 380 gr, 280 gr net

MXS Krom Efekt Sprey 5.00 \$
400 ml, 380 gr, 280 gr net

MXS Bronz Efekt Sprey 5.00 \$
400 ml, 380 gr, 280 gr net

MXS Paslanmaz Bakım Sprey 3.52 \$
400 ml, 370 gr, 265 gr net



MXS Eter Sprey 2.67 \$
200 ml

MXS Buz Çözücü Sprey 4.13 \$
400 ml, 365 gr, 260 gr net

**MXS MS-40 Çok Amaçlı Bakım Genel Yağlama Sprey**

200 ml, 200gr, 135 gr net 2.22 \$
400 ml, 375 gr, 280 gr net 3.55 \$
5 litre bidon 43.70 \$

COLORIUM Çok Amaçlı Bakım Genel Yağlama Sprey

200 ml, 185gr, 120 gr net 1.82 \$
400 ml, 330 gr, 350 gr net 3.04 \$



MXS Zincir ve Halat Sprey 3.07 \$
400 ml, 375 gr, 280 gr net

Colorium Zincir Halat Sprey 2.85 \$
400 ml, 330 gr, 230 gr net

MXS Zift Katran Temizleme Sprey 4.04 \$
400 ml, 375 gr, 280 gr net



MxS Kontakt Sprey Devre Temizleyici, Yağsız 2.03 \$
200 ml, 200gr, 135 gr net
400 ml, 365 gr, 270 gr net 3.34 \$

Kontakt sprey devre temizleyici, elektrik bağlantılarında iletkenliği güçlendirmek için kullanılan bir temizlik ürünüdür:

MxS Kontakt Sprey Devre Temizleyici, Yağlı 2.16 \$
200 ml, 200gr, 135 gr net
400 ml, 365 gr, 270 gr net 3.56 \$

Kontakt sprey devre temizleyici, akü kutup başı parçaların temizlenmesinde kullanılan bir spreydür.



MXS Pütür Siyah, 1000 gr 5.36 \$

MXS Pütür Sprey 4.52 \$
500 ml, 475 gr, 360 gr net

MXS

Mükemmel Sonuç



MXS Kalıp Ayırıcı Sprey Silikonlu 3.34 \$
400 ml, 365 gr, 270 gr net

MXS Kalıp Ayırıcı Sprey Silikonsuz 3.19 \$
400 ml, 365 gr, 270 gr net

MXS Kalıp Koruyucu Mum Sprey 4.68 \$
400 ml, 375 gr, 280 gr net



MXS Gazaltı Kaynak Sprey Silikonlu 3.34 \$
400 ml, 425 gr, 330 gr net

MXS Gazaltı Kaynak Sprey Silikonsuz 3.19 \$
400 ml, 425 gr, 330 gr net



MXS H3000 Sıvı Gres Sprey 2.92 \$
400 ml, 375 gr, 270 gr net

MXS H3000 Sıvı Gres Sprey 3.31 \$
500 ml

COLORIUM H3000 Sıvı Gres Sprey 2.70 \$
400 ml, 340 gr, 235 gr net

MXS H3000 Lityum Sıvı Gres Sprey 3.37 \$
400 ml, 375 gr, 270 gr net



COLORIUM Pas Sökücü Sprey 1.76 \$
200 ml, 185gr, 120 gr net

400 ml, 330 gr, 235 gr net 2.92 \$

MXS Pas Sökücü Sprey 3.19 \$
400 ml, 340 gr, 235 gr net



MXS Lastik Tamir Kiti Sprey
400 ml, 445 gr, 335 gr net 3.83 \$



MXS Motor Temizleme Sprey
500 ml, 445 gr, 330 gr net 4.01 \$
Solvent Bazlı

MXS Döşeme Temizleme Köpük Sprey
500 ml 3.52 \$



MXS Silikon Sprey
400 ml, 345 gr, 240 gr net 3.10 \$
COLORIUM Silikon Sprey
400 ml, 345 gr, 240 gr net 2.98 \$



MXS Klima Temizleme Dezenfekte
500 ml, 515 gr, 400 gr net 2.89 \$

MXS Klima Koku Giderici Sprey
200 ml, 425gr, 330 gr net
Lavanta 2.40 \$
Elma 2.40 \$
Potpori 2.40 \$



MXS Isıya Dayanıklı Sprey
400 ml, 380 gr, 280 gr net 6.02 \$
Siyah - Kırmızı - Gümüş



MXS Sprey Boya
400 ml, 380 gr, 280 gr net 3.46 \$

Parlak Renkler
1013 İnci Beyaz
1015 Açık Fildişi
1028 Kavun Sarı
3000 Alev Kırmızı
3002 Karmen Kırmızı
3004 Bordo
5002 Ultramarin Mavi
5015 Gök Mavi
5021 Su Mavisı
6002 Yaprak Yeşil
6005 Gri Yeşil
6018 Sarı Yeşil
6026 Opal Yeşil
7001 Gümüş Gri
7016 Antrasit Gri
7031 Mavi Gri
7035 Açık Gri
8003 Kil Kahve
8011 Ceviz
8017 Çikolata Kahve
9001 Krem
9005 Parlak Siyah
9010 Parlak Beyaz

Trafik Renkler
1023 Trafik Sarı
2009 Trafik Turuncu
3020 Trafik Kırmızı
5017 Trafik Mavi
7043 Trafik Gri
9016 Trafik Beyaz
9017 Trafik Siyah

Sinyal Renkler
1003 Sinyal Sarı
3001 Sinyal Kırmızı
5005 Sinyal Mavi
7004 Sinyal Gri
8002 Sinyal Kahverengi
9003 Sinyal Beyaz
9004 Sinyal Siyah

Floresan Renkler
Floresan Sarı
Floresan Kırmızı
Floresan Kavuniçi
Floresan Yeşil

Mat Renkler
9005-M Mat Siyah
9010-M Mat Beyaz

MXS Floresan Sprey Boya
400 ml, 380 gr, 280 gr net 5.38 \$

MXS Sprey Vernik Mat
400 ml, 380 gr, 280 gr net 3.99 \$

MXS XL Pro Sprey Vernik Mat
500 ml, 475 gr, 360 gr net 5.32 \$

MXS Sprey Vernik Parlak
400 ml, 380 gr, 280 gr net 3.46 \$

MXS XL Pro Sprey Vernik Parlak
500 ml, 380 gr, 280 gr net 4.61 \$

COLORIUM Sprey Boya
400 ml, 350 gr, 250 gr net 2.66 \$
5005 Sinyal Mavi 7016 Antrasit Gri
3002 Karmen Kırmızı 3001 Sinyal Kırmızı



HELPER Sprey Boya
200 ml, 175 gr, 110 gr net 1.38 \$
400 ml, 300 gr, 205 gr net 2.07 \$

9005-M Mat Siyah 3020 Trafik Kırmızı
9005 Parlak Siyah 1003 Sinyal Sarı
9010 Parlak Beyaz 9003 Sinyal Beyaz
9006 Gümüş 6017 Mayıs Yeşili
5017 Trafik Mavi

MXS

Mükemmel Sonuç



MXS Dolgu Astarı Sprey
400 ml, 380 gr, 280 gr net 3.46 \$

MXS Dolgu Astarı Sprey
500 ml 4.53 \$

MXS Plastik Astar Sprey
400 ml 4.33 \$

MXS Boya Sökücü Sprey
400 ml, 350 gr, 250 gr net 3.30 \$

MXS Boya Sökücü
1000 gr 8.21 \$

HELPER Boya Sökücü
1000 gr 7.11 \$



MXS Radyatör Delik Tıkama
300 ml, 305 gr, 240 gr net 3.40 \$

MXS Benzin Enjektör Temizleyici
300 ml, 305 gr, 240 gr net 3.40 \$

MXS Dizel Enjektör Temizleyici
300 ml, 305 gr, 240 gr net 3.55 \$



MXS Motor İç Temizleyici
300 ml, 305 gr, 240 gr net 3.67 \$

MXS Radyatör İç Temizleme
300 ml, 305 gr, 240 gr net 3.40 \$

MXS Dizel Patikül Filtre Temizleme
300 ml, 305 gr, 240 gr net 3.67 \$
500 ml 7.60 \$

MXS Emisyon Düşürücü
300 ml, 305 gr, 240 gr net 3.67 \$

MXS Duman Kesici
300 ml, 305 gr, 240 gr net 3.40 \$

MXS Motor Yağ Katkısı
300 ml, 305 gr, 240 gr net 3.40 \$

MXS Lifter Ses Kesici Katkı
300 ml, 305 gr, 240 gr net 3.40 \$



MxS Benzin Yakıt Katkısı

300 ml 3.55 \$

MxS Dizel Yakıt Katkısı

300 ml 3.68 \$



MxS Dizel Yakıt Antifiriz

300 ml 3.67 \$



MxS Pütür Boyanabilir

Alt Kaplama 5.36 \$

Siyah

1 kg

MxS Pütür Boyanabilir

Alt Kaplama 5.36 \$

Gri

1 kg



MxS XL Pro Sprey Boya

500 ml, 475 gr, 360 gr net 4.53 \$

9005 Parlak Siyah Jant Boya

9010 Parlak Beyaz Astar Gri

3020 Parlak Kırmızı 9005-M Mat Siyah

**Teflon Bant**

12 mm x 8 mt	MK0715	0.145 \$
19 mm x 30 mt	MK0716	0.560 \$

Teflon Bant

12 mm x 8 mt	MES 701	0.20 \$
19 mm x 30 mt	MES 702	0.80 \$

Gaz Teflon Bant

12 mm x 8 mt	MK0720	0.42 \$
--------------	--------	---------

**Çift Taraflı Akrilik Bant**

18 mm x 2 mt	MK0812	0.63 \$
25 mm x 2 mt	MK0813	0.77 \$

**Elektrik Bantları**

0.13 mm x 0.19 mm x 10 yard		
Siyah	MK0750	0.43 \$
Beyaz	MK0760	0.43 \$
Kırmızı	MK0770	0.43 \$
Mavi	MK0780	0.43 \$
Yeşil	MK0790	0.43 \$
Sarı	MK0800	0.43 \$
Gri	MK0810	0.43 \$

**Merdiven Kaydırmazlık Bant**

25 mm x 15 mt - Siyah	MK0832	3.30 \$
25 mm x 25 mt - Siyah	MK0834	5.10 \$
50 mm x 10 mt - Siyah	MK0836	4.40 \$
50 mm x 15 mt - Siyah	MK0838	6.60 \$
50 mm x 25 mt - Siyah	MK0840	10.30 \$
25 mm x 15 mt - Sarı Siyah	MK0842	4.40 \$
50 mm x 15 mt - Sarı Siyah	MK0843	9.00 \$

Merdiven Kaydırmazlık Bant

25 mm x 25 mt - Siyah	MES 1442	7.10 \$
-----------------------	----------	---------

Merdiven Kaydırmazlık Bant

36 mm x 25 mt - Siyah		10.00 \$
-----------------------	--	----------

**Alçıpan Derz Bandı**

48 mm x 45 yard	MK0815	1.60 \$
48 mm x 90 yard	MK0816	3.10 \$
96 mm x 90 yard	MK0818	6.10 \$

Tamir Bandı

48 mm x 10 yard, Gri	MK0726	0.88 \$
48 mm x 10 yard, Beyaz	MK0727	0.88 \$
48 mm x 10 yard, Siyah	MK0728	0.88 \$
48 mm x 10 yard, Kırmızı	MK0729	0.88 \$
48 mm x 10 yard, Sarı	MK0730	0.88 \$
48 mm x 10 yard, Mavi	MK0731	0.88 \$
48 mm x 10 yard, Yeşil	MK0732	0.88 \$

Tamir Bandı

48 mm x 10 yard, Gri	MES 4513	1.05 \$
----------------------	----------	---------

**Ballysan Kontakt Yapıştırıcı**

50 gr	MK1410	0.65 \$
-------	--------	---------

**Japon Yapıştırıcı**

20 gr	MK1380	0.48 \$
-------	--------	---------

Bond 505 Yapıştırıcı

20 gr	MES 1827	0.60 \$
-------	----------	---------

**İki Karışimli Çelik Yapıştırıcı**

10 gr + 10 gr	MK1400	0.74 \$
---------------	--------	---------

İki Karışimli Çelik Yapıştırıcı Şeffaf

7.5 gr + 7.5 gr	MK1404	1.00 \$
-----------------	--------	---------

İkili Çelik Yapıştırıcı Set

20 gr	MES 143	1.20 \$
-------	---------	---------

**Kağıt Maskeleme Bantları**

18 mm x 20 mt	MK0736	0.37 \$
24 mm x 20 mt	MK0737	0.48 \$
36 mm x 20 mt	MK0738	0.72 \$
48 mm x 20 mt	MK0739	0.96 \$

**Sızdırmazlık Bandı**

48 mm x 2 mt	MK0844	1.15 \$
72 mm x 2 mt	MK0845	1.68 \$
96 mm x 2 mt	MK0846	2.24 \$

Çift Taraflı Köpük Bant

18 mm x 2 mt	MK0811	0.34 \$
--------------	--------	---------

**Kapı Altı Sızdırmazlık Bandı**

40 mm x 3 mt	MK0856	2.05 \$
--------------	--------	---------

**Küvet Lavabo Su Sızdırmazlık Bandı**

22 mm x 3.2 mt	MK0850	1.82 \$
38 mm x 3.2 mt	MK0852	2.00 \$



Kağıt Maskeleye Bantları

19 mm x 25 mt
25 mm x 25 mt
36 mm x 25 mt
48 mm x 25 mt

0.50 €
0.65 €
1.00 €
1.23 €



Çift Taraflı Köpük Bant

10 mm x 10 mt	170 Adet	72153	0.65 \$
15 mm x 10 mt	150 Adet	72155	0.95 \$
20 mm x 10 mt	100 Adet	72157	1.28 \$
25 mm x 10 mt	70 Adet	72159	1.65 \$
30 mm x 10 mt	60 Adet	72161	1.90 \$
40 mm x 10 mt	50 Adet	72165	2.55 \$
50 mm x 10 mt	35 Adet	72167	3.15 \$



Çift Taraflı Filmik Bant

12 mm x 25 mt	72170	0.70 €
18 mm x 25 mt	72171	0.88 €
24 mm x 25 mt	72172	1.15 €
36 mm x 25 mt	72173	1.80 €
48 mm x 25 mt	72174	2.30 €



Eriyen Bant

19 x 10 mt
50 x 10 mt

2.75 \$
6.00 \$



Polyester Siyah Tüylü Bant

19 mm x 15 mt

2.45 €



Koli Bant Makinası
Koli Bant Makinası Büyük

7.30 \$
21.00 \$



Alüminyum Folyo Bant

48x25 mt
75x25 mt
96x25 mt -

1.90 \$
2.85 \$
3.75 \$



Alüminyum Folyo Bant Takviyeli

48x25 mt
96x25 mt

2.00 \$
4.50 \$



PVC Cam Bandı

45 mm x 30 mt - Turuncu

3.50 €



Doğalgaz PVC Anti Korozyon Bant

0.50 mm x 50 mm x 25 mt
0.50 mm x 100 mm x 25 mt

13.20 \$
26.60 \$



Yer İşaretleme Bandı

50x30 mt - Sarı, Beyaz, Kırmızı, Yeşil
50x30 mt - Sarı/Siyah
50x30 mt - Kırmızı/Beyaz

4.25 \$
4.85 \$
4.65 \$



Doğalgaz Macunu

400 gr

2.56 \$



Plastik Çember Otomatik Beyaz (Dar Kasnak)

8 mm	105.00 TL / Kg
10 mm	105.00 TL / Kg
12 mm	105.00 TL / Kg

Plastik Çember Manuel Siyah (Geniş Kasnak)

12 mm	97.00 TL / Kg
16 mm	97.00 TL / Kg

Plastik Çember Manuel Beyaz (Geniş Kasnak)

12 mm	105.00 TL / Kg
-------	----------------

Polyester Çember Yeşil

12 mm - 2200 mt	1400.- TL / Top
16 mm - 1400 mt	1400.- TL / Top



Kompozit Lifli Çember

13 mm - 1100 mt	45.36 € / Bobin
16 mm - 850 mt	40.50 € / Bobin
19 mm - 600 mt	37.26 € / Bobin
25 mm - 400 mt	34.83 € / Bobin
34 mm - 300 mt	61.00 € / Bobin

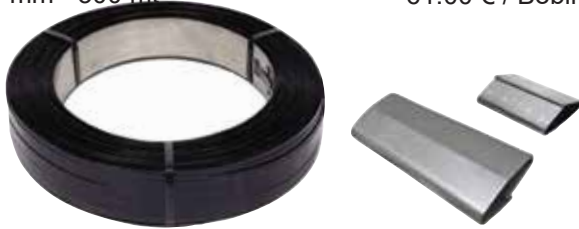

Çelik Ambalaj Şeridi

16x0.5 mm - Siyah	36112	3.45 \$ / Kg
19x0.5 mm - Siyah	36113	3.45 \$ / Kg
32x0.8 mm - Siyah	36115	3.10 \$ / Kg

Çelik Çember Klipsi Kapalı

16 mm (4000 adet torba)	36117	0.058 \$ / Adet
19 mm (4000 adet torba)	36118	0.058 \$ / Adet
32 mm (1000 adet torba)		0.145 \$ / Adet



U-182 Çelik Çember Germe

16 mm - 19 mm	36122	175.- \$
---------------	-------	----------

S-298 Çelik Çember Germe

32 mm		400.- \$
-------	--	----------



Çelik Çember Tokalama

U16 - 16 mm	36123	75.- \$
U19 - 19 mm		75.- \$
U32 - 19 mm		260.- \$



Plastik Çember Bukle Tel Tokası

13 mm	36129	29.00 \$ / Paket
1000 adet/torba		
16 mm	36130	32.00 \$ / Paket
1000 adet/torba		
19 mm	36132	47.00 \$ / Paket
1000 adet/torba		
25 mm	36131	55.00 \$ / Paket
500 adet/torba		
32 mm	36133	74.00 \$ / Paket
250 adet/torba		



Plastik Çember Plastik Toka

13 mm, 16 mm, 19 mm için	36146	270.- TL / Torba
Torba adedi: 1000		



Plastik Çember Metal Saç Tokası

12'lik - 0.40 mm	36148	288.- TL / Torba
1200 adet/torba		
16'lık - 0.40 mm	36150	288.- TL / Torba
800 adet/torba		
19'luk - 0.40 mm	36152	288.- TL / Torba
500 adet/torba		



Plastik Ambalaj Köşebentli

12 - 16 mm - 1000 Adet/Torba	36119	256.- TL / Torba
16 - 19 mm - 2000 Adet/Torba	36127	600.- TL / Torba
25 - 32 mm - 1000 Adet/Torba	36128	810.- TL / Torba



HP 19 P



HP 12 PP

Koli Çember Makinası	36047	81.- \$
----------------------	-------	---------

HP 19 P

Portatif Koli Çember Makinası	36046	51.- \$
-------------------------------	-------	---------



Plastik File ve Koruma Kılıfı

10 mm çap	175.00 TL / Kg
20-50 mm çap	140.00 TL / Kg



Çırpı İpi Çeşitleri

100 gr	21.00 TL
200 gr	49.00 TL
400 gr	82.00 TL

Boyalı Çırpı İpi

Kırmızı MK0410	2.35 \$
Mavi MK0411	2.35 \$

Çırpı İpi Çeşitleri

Mavi MES 546	3.40 \$
Kırmızı MES 547	3.40 \$



Paket İpi 115.00 TL / kg



Çuval Ağız İpi 115.00 TL / kg



Ambalaj İpi 115.00 TL / kg



İskota Halat

3 mm	5.60 \$ / kg
4 mm	5.60 \$ / kg
5 mm	4.80 \$ / kg
6 mm	3.70 \$ / kg
8 mm	3.70 \$ / kg
10 mm	3.70 \$ / kg
12 mm	3.70 \$ / kg



Kendir Jüt Halat

3 mm	6.75 \$ / kg
4 mm	6.75 \$ / kg
5 mm	6.10 \$ / kg
6 mm	6.10 \$ / kg
8 mm	6.10 \$ / kg
10 mm	6.10 \$ / kg
12 mm	6.10 \$ / kg



Jüt Kuka İp

100 gr	35.00 TL
200 gr	68.00 TL



Streç Fil Polietilen

17 Mikron
50 cm, 2.250 kg 7.30 \$/Adet
6 Adet / Koli

23 Mikron
50 cm, 2.250 kg 7.30 \$/Adet
6 Adet / Koli

17 Mikron
50 cm, 1.300 kg 4.00 \$/Adet
6 Adet / Koli

23 Mikron
50 cm, 1.300 kg 4.00 \$/Adet
6 Adet / Koli

17 Mikron
10 cm 1.95 \$/Adet

17 Mikron
1.8 kg 5.75 \$/Adet

23 Mikron
1.8 kg 5.75 \$/Adet

Streç Film Siyah
1800 kg 6.50 \$/Adet



Çöp Torbaları
Orta Boy 13.25 TL/Paket
55x60 cm

Büyük Boy 15.50 TL/Paket
65x60 cm

Jumbo Boy 25.00 TL/Paket
80x100 cm



Doli Siyah Hantal
100x150 cm 58.00 TL/Paket

Endüstriyel Jumbo Çöp Torbası
80x110 cm 47.00 TL/Paket

Dökme Çöp Torbası
80x110 cm 65.00 TL/Kg
100x150 cm 65.00 TL/Kg



Kilitli Naylon Torba
7x9 cm 19.00 TL / torba
9x11 cm 29.00 TL / torba
14x11 cm 43.00 TL / torba
17x23 cm 108.00 TL / torba
19x25 cm 150.00 TL / torba
23x31 cm 155.00 TL / torba
100 adetlik paketlerde



Plastik Bardak Otomat

180 cc 71182 23.00 TL/torba
100 Adet / Torba

Plastik Bardak Otomatı

90.00 TL



Kağıt Bardak

175 cc 00572 26.00 TL/torba
50 Adet / Torba

Köpük Bardak

175 cc 32.00 TL/torba
40 Adet / Torba



Plastik Karıştırıcı Çubuk

Beyaz 00571 35.00 TL/torba
Şeffaf 00574 35.00 TL/torba
1000 Adet / Torba



Plastik Çatal

170 mm 01489 39.00 TL/Paket
100 Adet / Paket

Plastik Kaşık

Küçük 125 mm 01488 39.00 TL/Paket
Büyük 160 mm 01487 46.00 TL/Paket
100 Adet / Paket

Plastik Bıçak

170 mm 01480 39.00 TL/Paket
100 Adet / Paket



Plastik Tabak

Küçük 125 mm 08023 21.00 TL/Paket
Orta 170 mm 08012 23.00 TL/Paket
Büyük 160 mm 08011 26.00 TL/Paket
100 Adet / Paket



Galoz

10'lu paket 15.00 TL
1000'li paket 200.00 TL



Saç Bonesi

10x20 75.00 TL
100'lü paket

Katlanır
90 kg



Paket Taşıma Arabası
300 kg 01325 74.- \$

Paket Taşıma Arabası
150 kg 01325 42.- \$



Geçme Kollu Katlanır Küçük Koli Taşıma Arabası
90 kg 50.- \$



Tekli Tüp Taşıma Arabası 36060 110.- \$
İkili Tüp Taşıma Arabası 36061 122.- \$



Varil Taşıma Arabası 36065 85.- \$
Damacana Su Taşıma Arabası 36066 94.- \$



Plastik Çember Arabası 36049 74.- \$
Kompozit Çember Arabası U-112 36050 73.- \$



Koli Taşıma Arabası 150 kg 36048 110.- \$
Koli Taşıma Arabası Merdiven Atlamalı 36045 315.- \$



Transpalet Junior marka 2.5 Ton 390.- \$

2500 kg kaldırma kapasitesi,
520x1220 mm çatal,
190mm kaldırma yüksekliği

Transpalet Döküm Pompa 2.5 Ton 440.- \$

2500 kg kaldırma kapasitesi,
520x1150 mm çatal,
200mm kaldırma yüksekliği



Varil Taşıma ve Kaldırma Arabası 36070 1225.- \$



Profil Merdiven

3 Basamak	74040110	710.- TL
4 Basamak	74040120	845.- TL
5 Basamak	74040130	970.- TL
6 Basamak	74040140	1107.- TL
7 Basamak	74040150	1260.- TL
8 Basamak	74040160	1495.- TL
9 Basamak	74040170	1675.- TL



PTT Merdiven Sürgülü, İki parçalı 2x200 cm 2x300 cm 2x400 cm

2x200 cm	2 325.- TL
2x300 cm	3 490.- TL
2x400 cm	5 400.- TL



Akrobat Merdiven

4 Kırım - 375 cm	3 345.- TL
4 Kırım - 475 cm	4 070.- TL
4 Kırım - 580 cm	5 235.- TL

Özel mafsal - kilit sistemleri sayesinde çok maksatlı olarak kullanılabilirler. Dört parçalı olması sebebiyle kapandıklarında çok az yer kaplarlar ve ufak araçların bagajlarına sığabilecek boyutlardadır.



Çift Çıkışlı Ev Tipi Merdivenler

3 Basamak	1 015.- TL
4 Basamak	1 310.- TL
5 Basamak	1 570.- TL
6 Basamak	1 890.- TL
7 Basamak	2 210.- TL
8 Basamak	2 410.- TL
9 Basamak	2 735.- TL



Telekopik Alüminyum İskele

2x9 Basamak - 4.94 mt	34 000.- TL
2x10 Basamak - 6.02 mt	37 000.- TL
2x12 Basamak - 7.10 mt	40 000.- TL
2x14 Basamak - 8.18 mt	43 000.- TL



A Tipi Sürgülü ve Sürgüsüz Merdiven Tekeri



Polyester Sapanlar 1x6 Gözlü

1 Ton - 1 Metre	3.95 \$
1 Ton - 2 Metre	4.95 \$
1 Ton - 3 Metre	6.78 \$
2 Ton - 2 Metre	7.18 \$
2 Ton - 3 Metre	9.50 \$
2 Ton - 5 Metre	14.00 \$
2 Ton - 6 Metre	16.70 \$
3 Ton - 3 Metre	13.30 \$
3 Ton - 5 Metre	20.95 \$
3 Ton - 6 Metre	23.55 \$
4 Ton - 3 Metre	16.70 \$
4 Ton - 6 Metre	31.65 \$
5 Ton - 1 Metre	9.25 \$
5 Ton - 3 Metre	21.25 \$
5 Ton - 5 Metre	33.40 \$
5 Ton - 6 Metre	39.30 \$
6 Ton - 3 Metre	28.00 \$
6 Ton - 5 Metre	43.60 \$
6 Ton - 6 Metre	51.90 \$



Tır Gümrük Halatı

4/6 mm şıkş ucu soketlidir.

36 mt	20.00 \$
38 mt	21.00 \$
40 mt	22.00 \$
42 mt	24.00 \$



Makaralı Emniyet Zinciri

3 mm	95.00 TL/kg
4 mm	95.00 TL/kg
5 mm	95.00 TL/kg
6 mm	95.00 TL/kg
7 mm	95.00 TL/kg
8 mm	95.00 TL/kg
9 mm	95.00 TL/kg
10 mm	95.00 TL/kg
12 mm	95.00 TL/kg
14 mm	95.00 TL/kg
16 mm	95.00 TL/kg



Kancalı Amerşikan Zinciri

2 Ton	29.00 \$
-------	----------



Mekanizmalı Mini Spanzet

25 mm x 3 mt	132.00 TL
25 mm x 5 mt	140.00 TL



Tokalı Mini Spanzet

Mandal Gerdirme	
25 mm x 3 mt	62.00 TL
25 mm x 5 mt	68.60 TL



Zincirli CARASKAL

1 ton - 3 metre	MK0500	88.40 \$
2 ton - 3 metre	MK0501	102.00 \$
1 ton - 5 metre	MK0502	95.00 \$
2 ton - 5 metre	MK0503	127.00 \$

Zincirli CARASKAL

1 ton - 3 metre	MES916	105.00 \$
2 ton - 3 metre	MES917	130.00 \$
1 ton - 5 metre	MES918	135.00 \$
2 ton - 5 metre	MES919	165.00 \$



Zincirli CARASKAL

1 ton - 3 metre	63.30 \$
1 ton - 5 metre	76.95 \$
2 ton - 3 metre	84.75 \$
2 ton - 5 metre	107.10 \$
3 ton - 3 metre	116.85 \$
3 ton - 5 metre	151.00 \$
5 ton - 5 metre	224.00 \$

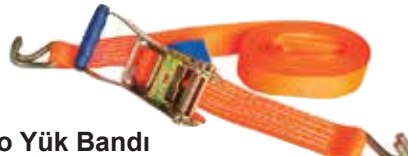

Oto Yük Bandı

25 mm x 4 mt (400 kg)	4.- \$/Adet
50 mm x 12 mt (2 ton)	
50 mm x 10 mt (2 ton)	8.- \$/Adet

Oto Yük Bandı Mekanizması

Oto Yük Bandı Spanzeti	5.- \$
------------------------	--------

Örme Kolon

1" - 25 mm	7.40 TL/ mt
2" - 50 mm	10.25 TL/ mt

100 metrelik toplar halinde satılır.



Hubzug Zincirli Çektirme

0.75 ton x 1.5 m	
1.50 ton x 1.5 m	103.32 \$
3.00 ton x 1.5 m	147.60 \$
6.00 ton x 1.5 m	201.72 \$



Elektrikli Caraskal

125 / 250 kg
500W - 20 m

250 / 500 kg
1000W - 20 m

400 / 800 kg
1300W - 20 m

500 / 1000 kg
1600W - 20 m

600 / 1200 kg
1900W - 20 m



Elektrikli Vinç

125 mm / 250 kg	MES 939	187.40 \$
250 mm / 500 kg	MES 938	249.00 \$
400 mm - 800 kg	MES 937	257.50 \$
600 mm / 1200 kg	MES 936	374.80 \$

Elektrikli Caraskal

125 - 250 kg	MK0510	155.00 \$
250 - 500 kg	MK0511	205.00 \$
400 - 800 kg	MK0512	222.00 \$
600 - 1200 kg	MK0513	314.00 \$



Zincir Gerdirme (Standart Kırmızı)

1/4 - 5/16"	33.00 \$
5/16 - 3/8"	47.00 \$
3/8 - 1/2"	70.00 \$
1/2 - 5/8"	93.00 \$

Zincir Gerdirme (Cırcırlı)

1/4 - 5/16"	42.00 \$
5/16 - 3/8"	54.00 \$
3/8 - 1/2"	58.00 \$
1/2 - 5/8"	72.00 \$

Gerdirme Halatlı Çektirme

1000 kg	36.11 \$
2000 kg	42.08 \$
3000 kg	52.60 \$
5000 kg	78.91 \$



6x7 FC LİFT ÖZLÜ GALVANİZ ÇELİK HALAT (DIN 3064)

Ölçü (mm)	MİN.K.Y. M.B.L/kg	kg/mt	Fiyat (USD)
2	248	0.014	0.145 \$
3	528	0.032	0.253 \$
4	940	0.056	0.441 \$
5	1460	0.088	0.668 \$

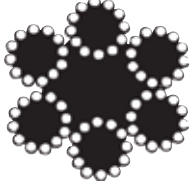

6x12 + 7 Gergi Halatı Galvaniz

Ölçü (mm)	MİN.K.Y. M.B.L/kg	kg/mt	Fiyat
6	1270	0.087	0.66 \$
8	2290	0.156	1.12 \$
10	3670	0.250	1.66 \$
12	5210	0.355	2.43 \$
14	7130	0.485	3.33 \$
16	9150	0.624	4.30 \$

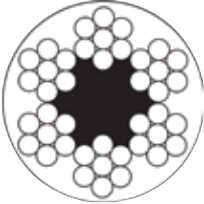

PVC İzoleli Çelik Halatlar Sarı renk, Şeffaf kaplama

Ölçü (mm)	MİN.K.Y. M.B.L/kg	kg/mt	Fiyat
1-2	140	0.029	0.125 \$
2-3	290	0.042	0.24 \$
3-4	550	0.057	0.38 \$
3-5	590	0.068	0.48 \$
4-6	940	0.098	0.76 \$
5-7	1360	0.155	1.21 \$
6-8	1620	0.185	1.10 \$
8-10	2450	0.295	1.74 \$
10-12	3680	0.470	2.35 \$

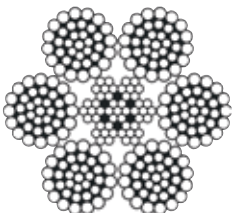

6x36 Galvaniz Çelik Halat (TS 1918/14)

24 mm	15.71 €/mt
26 mm	18.40 €/mt

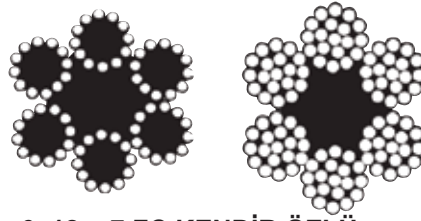

6x12 + 7 FC KENDİR ÖZLÜ ÇELİK HALAT SİYAH

Ölçü (mm)	MİN.K.Y. M.B.L/kg	kg/mt	Fiyat
6	1270	0.087	0.634 \$
8	2290	0.156	1.053 \$
10	3670	0.250	1.628 \$
12	5210	0.355	2.349 \$
14	7130	0.485	3.216 \$
16	9150	0.624	4.160 \$

KENDİR ÖZLÜ ÇELİK HALAT 6x19 FC + Lift Özlü Siyah (DIN 3060)

İnşaat vinçlerinde kullanılır.

Ölçü (mm)	MİN.K.Y. M.B.L/kg	kg/mt	Fiyat
6	1990	0.125	0.911 \$
8	3540	0.221	1.555 \$
10	5530	0.346	2.336 \$
12	7970	0.498	3.340 \$
14	10800	0.678	4.440 \$
16	14200	0.886	5.510 \$
20	23000	1.480	9.100 \$
22	26800	1.670	10.20 \$
24	34315	2.146	10.80 \$

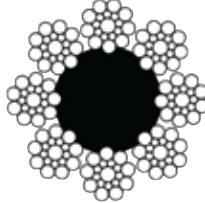

ASANSÖR HALATI 8x19 S + Lift Özlü (TS 1918/18)

Ölçü (mm)	MİN.K.Y. M.B.L/kg	kg/mt	Fiyat
8	3650	0.232	2.26 €
10	5170	0.348	2.70 €
12	6250	0.422	3.85 €



6x19 + Lift Özlü (TS 1918/10)

Ölçü (mm)	MİN.K.Y. M.B.L/kg	kg/mt	Fiyat
6	1990	0.125	1.13 \$
8	3540	0.221	1.70 \$
10	5530	0.346	2.57 \$
12	7970	0.498	3.65 \$
14	10800	0.678	4.95 \$
16	14200	0.866	6.45 \$

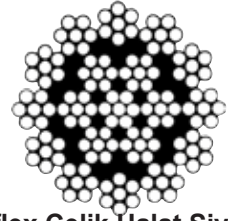

19x7 Nuflex Çelik Halat Siyah

4 mm	0.758 \$
5 mm	1.126 \$
6 mm	1.328 \$
8 mm	2.250 \$
10 mm	3.441 \$
12 mm	4.897 \$
14 mm	6.543 \$
16 mm	8.867 \$
18 mm	11.222 \$
20 mm	13.200 \$

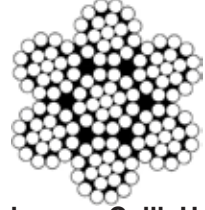

7x19 Paslanmaz Çelik Halat 316 Kalite

5 mm	1.91 \$
6 mm	2.66 \$



Zincir Kancası

1/4" 6 mm	3.175 \$
5/16" 8 mm	4.410 \$
3/8" 10 mm	5.261 \$
1/2" 13 mm	10.970 \$

Sapan Kancası

1/4" 6 mm	3.89 \$
5/16" 8 mm	4.74 \$
3/8" 10 mm	6.99 \$
1/2" 13 mm	14.56 \$



Emniyet Pimli Kanca G80

7/8" - 2 ton	18.05 \$
--------------	----------



Fırdöndü Kanca

1 Ton	7.62 \$
1.5 Ton	9.25 \$
2 Ton	13.51 \$
3 Ton	15.56 \$
5 Ton	26.67 \$
7 Ton	55.64 \$

Kuşgöz Kanca

0.75 Ton	3.51 \$
1 Ton	3.87 \$
1.5 Ton	4.74 \$
2 Ton	6.72 \$
3 Ton	9.70 \$
4.5 Ton	16.50 \$



Klemens A Tip Galvaniz

3 mm	0.090 \$
5 mm	0.107 \$
6 mm	0.160 \$
8 mm	0.234 \$
10 mm	0.511 \$
12 mm	0.930 \$
14 mm	1.406 \$
18 mm	1.757 \$
20 mm	2.545 \$
22 mm	3.429 \$
25 mm	5.527 \$
28 mm	7.604 \$
32 mm	9.915 \$
36 mm	12.823 \$
40 mm	16.113 \$
45 mm	23.507 \$
50 mm	33.111 \$



Düz Kilit Galvaniz

6 mm	0.341 \$
8 mm	0.540 \$
10 mm	0.810 \$
12 mm	1.246 \$



Karabina Galvaniz

4 mm	0.280 \$
5 mm	0.298 \$
6 mm	0.397 \$
7 mm	0.543 \$
8 mm	0.698 \$
9 mm	0.957 \$
10 mm	1.189 \$
11 mm	1.629 \$
12 mm	2.407 \$
13 mm	3.755 \$
14 mm	4.807 \$



Vidalı Karabina Galvaniz

4 mm	0.405 \$
5 mm	0.405 \$
6 mm	0.511 \$
7 mm	0.628 \$
8 mm	0.799 \$
10 mm	1.289 \$
12 mm	2.535 \$



Standart Gerdirme Galvaniz

6 mm	0.490 \$
8 mm	0.788 \$
10 mm	1.076 \$
12 mm	2.364 \$
14 mm	3.120 \$
16 mm	4.640 \$
20 mm	8.220 \$
22 mm	11.590 \$
25 mm	15.017 \$



Aybolt Erkek (DIN 580)

6 mm	0-14 Ton	1.02 \$
8 mm	0-14 Ton	1.10 \$
10 mm	0.23 Ton	1.56 \$
12 mm	0.34 Ton	2.20 \$
14 mm	0.58 Ton	2.28 \$
16 mm	0.70 Ton	3.45 \$
18 mm	0.98 Ton	3.55 \$
20 mm	1.20 Ton	5.00 \$
22 mm	1.60 Ton	5.13 \$
24 mm	1.80 Ton	9.95 \$
27 mm		12.70 \$
30 mm	3.60 Ton	19.80 \$
33 mm		31.65 \$
36 mm	5.10 Ton	31.65 \$
42 mm	6.10 Ton	49.25 \$

Aybolt Dişi (DIN 580)

6 mm	0-14 Ton	0.94 \$
8 mm	0-14 Ton	0.94 \$
10 mm	0.23 Ton	1.52 \$
12 mm	0.34 Ton	2.15 \$
14 mm	0.58 Ton	2.20 \$
16 mm	0.70 Ton	3.40 \$
18 mm	0.98 Ton	3.45 \$
20 mm	1.20 Ton	4.90 \$



Fırdöndü Galvaniz

6 mm	360 Ton	2.034 \$
8 mm	500 Ton	2.641 \$
10 mm	900 Ton	4.058 \$
12 mm	1400 Ton	8.840 \$
16 mm	2000 Ton	12.365 \$
20 mm	2900 Ton	19.380 \$
22 mm	4000 Ton	26.071 \$
25 mm	7000 Ton	47.691 \$



Kilitli Fırdöndü Galvaniz

6 mm	360 Ton	3.45 \$
8 mm	500 Ton	4.40 \$
10 mm	900 Ton	5.60 \$
12 mm	1400 Ton	10.55 \$
16 mm	2000 Ton	13.70 \$
20 mm	2900 Ton	23.20 \$
22 mm	4000 Ton	40.00 \$
25 mm	7000 Ton	56.00 \$



Radansa (DIN 6899 - B)

6 mm	0.170 \$
8 mm	0.224 \$
10 mm	0.288 \$
12 mm	0.437 \$
14 mm	0.586 \$
16 mm	0.948 \$



Tonajlı Kilitler Omega G-209

5/16"	0.75 Ton	1.353 \$
3/8"	1 Ton	1.864 \$
1/2"	2 Ton	3.781 \$
5/8"	3.25 Ton	6.710 \$
3/4"	4.75 Ton	10.416 \$
7/8"	6.50 Ton	15.538 \$
1"	8.50 Ton	21.620 \$
1 1/8"	9.50 Ton	30.587 \$
1 1/4"	12 Ton	43.026 \$
1 3/8"	13.50 Ton	58.884 \$
1 1/2"	17 Ton	76.650 \$
1 3/4"	25 Ton	129.530 \$
2"	35 Ton	192.130 \$



Tonajlı Kilitler Düz G-210 Somunlu

5/16"	0.75 Ton	1.54 \$
3/8"	1 Ton	2.03 \$
1/2"	2 Ton	4.16 \$
5/8"	3.25 Ton	7.04 \$
3/4"	4.75 Ton	10.84 \$
7/8"	6.50 Ton	15.87 \$
1"	8.50 Ton	21.96 \$
1 1/8"	9.50 Ton	31.34 \$
1 1/4"	12 Ton	43.37 \$
1 3/8"	13.50 Ton	58.63 \$



Tonajlı Kilitler Omega G-209 Somunlu

5/16"	0.75 Ton	1.61 \$
3/8"	1 Ton	2.16 \$
1/2"	2 Ton	4.25 \$
5/8"	3.25 Ton	7.29 \$
3/4"	4.75 Ton	11.19 \$
7/8"	6.50 Ton	16.70 \$
1"	8.50 Ton	22.23 \$
1 1/8"	9.50 Ton	32.70 \$
1 1/4"	12 Ton	46.05 \$
1 3/8"	13.50 Ton	61.50 \$
1 1/2"	17 Ton	80.40 \$
1 3/4"	25 Ton	137.90 \$
2"	35 Ton	197.71 \$



Tonajlı Kilitler Düz G-210

5/16"	0.75 Ton	1.30 \$
3/8"	1 Ton	1.77 \$
1/2"	2 Ton	3.66 \$
5/8"	3.25 Ton	6.35 \$
3/4"	4.75 Ton	9.92 \$
7/8"	6.50 Ton	14.62 \$
1"	8.50 Ton	20.22 \$
1 1/8"	9.50 Ton	28.88 \$
1 1/4"	12 Ton	39.63 \$

Yivli Kaput Kilidi 44.00 TL

Yeni Kaput Kilidi 37.70 TL

Büyük Kaput Kilidi 66.00 TL

Küçük Kaput Kilidi 44.00 TL

Yeni Açık Kasa Kilidi 173.00 TL

Transit Kilidi 138.00 TL

Düz Dorse Kilidi 392.- TL

Demir Kapı Sürgüsü
14 mm 38.00 TL
18 mm 42.00 TL

Yaylı Ferforje Sürgüsü
100 mm 57.00 TL
150 mm 75.00 TL
200 mm 96.00 TL
300 mm 126.00 TL

Orjinal Yaylı Pim
6 mm 5.80 TL
8 mm 6.00 TL
10 mm 7.00 TL



Çift Rulmanlı V Makara

40 mm	41800	66.50 TL
50 mm	41801	84.25 TL
60 mm	41802	126.00 TL
70 mm	41803	169.00 TL
80 mm	41804	204.00 TL
90 mm	41805	255.00 TL
100 mm	41806	308.00 TL
120 mm	41807	434.00 TL

Çift Rulmanlı Kulaklı V Makara

30 mm		68.00 TL
40 mm	41810	89.00 TL
50 mm	41811	111.00 TL
60 mm	41812	143.00 TL
70 mm	41813	203.00 TL
80 mm	41814	255.00 TL
90 mm	41815	344.00 TL
100 mm	41816	506.00 TL
120 mm	41817	526.00 TL

Bayrak Makarası Plastik
40 mm 43.00 TL

Kablo Taşıyıcı Makarası
Plastik 12.00 TL

Denge Makarası Metal
Bilyalı 55.00 TL

Denge Makarası Plastik
Bilyalı 40.50 TL

Karoser Yaprak Mentеше
4 mm 33.25 TL
5 mm 42.00 TL
6 mm 52.00 TL
8 mm 58.00 TL

Karoser Kapak Kaması 19.50 TL
Römork Kaması Galvaniz 22.00 TL
Karoser Kapak Kilitli Laması
45x10x100 mm 28.00 TL

Karoser Tırtırlı Kapak Kilidi
Erkek Galvanizli 48.00 TL
Karoser Kapak Sallama Halkası
10 mm 36.50 TL

Mil Mentеше

Ø10 mm x 50 mm	41670	9.60 TL
300 Adet/Paket		
Ø12 mm x 55 mm	41680	11.45 TL
200 Adet/Paket		
Ø14 mm x 60 mm	41690	17.80 TL
150 Adet/Paket		
Ø16 mm x 70 mm	41700	19.00 TL
120 Adet/Paket		
Ø18 mm x 80 mm	41710	23.90 TL
120 Adet/Paket		
Ø20 mm x 80 mm	41720	33.60 TL
100 Adet/Paket		
Ø22 mm x 85 mm	41730	43.60 TL
72 Adet/Paket		
Ø24 mm x 100 mm	41740	55.90 TL
66 Adet/Paket		
Ø26 mm x 110 mm	41750	76.95 TL
50 Adet/Paket		

16,18,20,22,24,26 mm mil menteşeler yağlama deliklidir.

Kanatlı Mentеше

22 mm	51.85 TL
24 mm	80.20 TL
26 mm	98.00 TL
30 mm	145.80 TL

Delikli Kanatlı Mentеше

14 mm	20.25 TL
16 mm	27.55 TL
18 mm	34.50 TL
20 mm	44.60 TL

Ayarlı Denge Makarası Metal
Çiftli 186.00 TL

Ayarlı Denge Makarası Plastik
Çiftli 162.00 TL

Ayarlı Denge Makarası Metal
Tekli 89.00 TL

Ayarlı Denge Makarası PVC
Tekli 64.00 TL

Salıncak Makarası
50 138.00 TL

Kablo Taşıyıcı Makara
40 mm 389.00 TL

Şaryo Makarası 414.00 TL



Tekerlek Takozu Plastik 410.00 TL



155010 Uzun Baba Erkek 27.50 TL

155100 Kısa İlave Erkek 27.50 TL



159100 Orta Damper Mentеше 79.00TL

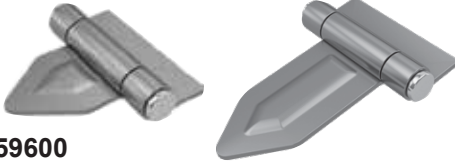

159600 Üçgen Mentеше Normal 71.00 TL

159700 Üçgen Mentеше Büyük 80.00 TL



Otosan Mentеше 70.00 TL



Sepet Römork Mentеше 70.00 TL



Kasa Kapak Çivisi Hortumlu
Tekli 36.00 TL
Tekli Kilitli 45.00 TL
Çiftli 75.00 TL
Çiftli Kilitli 98.00 TL



Kamyon Kasa Bağlantı
8 mm Galvaniz 27.50 TL
10 mm Galvaniz 50.00 TL



313 800, El Vinci Halatlı
313 820, Frensiz 1200 LB 1 300.00 TL
313 840, Frenli 1600 LB 2 535.00 TL
313 845, Frenli 2000 LB 4 800.00 TL



Ayarlı Kriko

Ayarlı Kriko
60'lık 60x60 1615.- TL
70'lık 70x70 Özel Tip 2150.- TL
80'lık 80x80 2400.- TL



Şanzıman Ayarlı Römork Krikosu

Şanzımanlı Ayarlı Römork Krikosu 60'lık 2 400.- TL

Şanzımanlı Ayarlı Römork Krikosu 70'lık 3 450.- TL



Şanzıman Römork Krikosu

Şanzıman Ayarlı Römork Krikosu 80'lık 3 600.- TL



Mini İlaçlama Krikosu 1650.- TL
50x50 profil

Q Kriko Plastik Tekerli 1415.- TL
650 kg



Kaplin Kare

Kaplin Döküm

Kare Kaplin 1800.00 TL
1400 Kg
800 Kg, e-Belgeli 940.00 TL

Kare Kaplin 3 750.- TL
3500 Kg

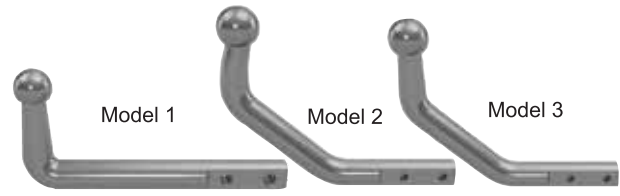

Model 1

Model 2

Model 3

Taksi Topuzu

Model 1, Dik, 10 kN 1500.00 TL
Model 2, Eğik, 10 kN 1500.00 TL
Model 3, Eğik, 10 kN 1500.00 TL



Antifiriz Bometresi 8.75 \$



Akü Bometresi 8.00 \$



Akü Kutup Başı
(+) 42.00 TL
(-) 42.00 TL



Şerit Reflektör 96.00 TL/Metre
Sarı, Beyaz, Kırmızı,
50 mm x 50 mt

Şerit Reflektör Ekonomik
Sarı, Kırmızı, Beyaz 15.00 TL/Metre
50 mm x 50 mt



Reflektörler Kamyon
28761 472.- TL/Çift



TIR 28762 632.- TL/Çift



Traktör 28763 365.- TL/Adet
Adet olarak satılır.



Akü Takviye Kablosu
1200 Amper 265.00 TL



Star Akü Takviye Kablosu
1500 Amper 505.00 TL



Çeki Halatı
3.5 ton 305.00 TL

Çeki Halatı Bez
2 ton, 4 metre 175.00 TL



Trafik Seti 565.- TL
Set; reflektör, yangın söndürme cihazı, boyunluk, yangın örtüsü, takoz, halat, ilk yardım ve el feneri



Lüks Trafik Seti 645.- TL
Set; reflektör, yangın söndürme cihazı, boyunluk, yangın örtüsü, takoz, halat, ilk yardım



El Pompası Kısa Krom MK4810 3.95 \$

El Pompası Ekonomik MK4800 6.30 \$

El Pompası Turuncu MK4830 11.10 \$

El Pompası Krom Saatli MK4820 10.40 \$



Top Şişirme Hortum Seti
5 parça 1.00 \$



Hava Kompresörü Küçük MK4900 31.80 \$
Hava Kompresörü Büyük MK4910 52.00 \$



Hava Kompresörü Elektrikli Küçük MK4920 42.00 \$
Hava Kompresörü Elektrikli Büyük MK4930 59.00 \$



Hava Jaki Hortum Girişli MK1285 2.40 \$
Hava Jaki Euro Girişli MK1286 2.40 \$



Eğri Kamyoncu Hava Jaki Hortum Girişli MK1287 3.30 \$
Eğri Kamyoncu Hava Jaki Euro Girişli MK1287-1 3.30 \$



Lastik Hava Basınç Ölçer 300 mm MK1287-2 6.90 \$



Hava Basma Uç Mandalı MK1287-10 1.50 \$



Ayak Pompası Kalın 2 piston MK4870 17.50 \$

Ayak Pompası Kalın 1 piston MK4840 11.70 \$



Ayak Pompası Kobra MK4850 17.80 \$



Motor Kilidi Yaylı 150 cm MK2476 11.50 \$



Motor Kilidi Yaylı 150 cm MK2478 12.50 \$



Bisiklet Kilidi 80 cm MK2470 2.65 \$

Bisiklet Kilidi 80 cm MES 601 2.60 \$



Bisiklet Kilidi Uzun 150 cm MK2472 5.00 \$

Bisiklet Kilidi 150 cm MES 602 6.00 \$



Şifreli Bisiklet Kilidi 80 cm MK2474 5.72 \$



Küçük Şarjlı El Feneri Mıknatıslı 00356 18.50 \$

Büyük Şarjlı El Feneri Mıknatıslı 00357 30.50 \$



İç Lastik Yaması 24'lü set MK4790 1.06 \$



Plastik Kaynak Elektrodu PP malzeme, 100 gr 3.12 \$



Dışa Geçme Köşeli Tapa

10x20 mm	250 Adet/torba	2.50 TL
20x20 mm	250 Adet/torba	2.90 TL
25x25 mm	250 Adet/torba	4.30 TL
20x30 mm	250 Adet/torba	4.30 TL
30x30 mm	250 Adet/torba	4.50 TL
40x40 mm	250 Adet/torba	5.30 TL



Dışa Geçme Yuvarlak Tapa

06 mm	250 Adet/torba	1.60 TL
13 mm	250 Adet/torba	1.90 TL
16 mm	250 Adet/torba	1.80 TL
19 mm	250 Adet/torba	1.80 TL
21 mm	250 Adet/torba	2.50 TL
25 mm	250 Adet/torba	1.80 TL
27 mm	250 Adet/torba	6.00 TL
28 mm	250 Adet/torba	6.30 TL
32 mm	250 Adet/torba	4.90 TL
76 mm	250 Adet/torba	20.00 TL



İçe Geçme Köşeli Tapa

10x20 mm	250 Adet/torba	1.50 TL
10x30 mm	250 Adet/torba	2.20 TL
15x25 mm	250 Adet/torba	1.80 TL
20x20 mm	250 Adet/torba	1.50 TL
20x30 mm	250 Adet/torba	1.90 TL
20x40 mm	250 Adet/torba	1.90 TL
25x25 mm	250 Adet/torba	1.90 TL
25x40 mm	250 Adet/torba	8.00 TL
30x30 mm	250 Adet/torba	2.00 TL
30x40 mm	250 Adet/torba	3.00 TL
30x50 mm	250 Adet/torba	4.70 TL
30x60 mm	250 Adet/torba	8.70 TL
40x40 mm	250 Adet/torba	4.00 TL
50x50 mm	250 Adet/torba	8.00 TL
40x60 mm	250 Adet/torba	6.00 TL
40x80 mm	250 Adet/torba	8.60 TL
40x100 mm	250 Adet/torba	25.00 TL
50x100 mm	250 Adet/torba	22.00 TL
60x60 mm	250 Adet/torba	8.00 TL
80x80 mm	250 Adet/torba	17.00 TL
100x100 mm	250 Adet/torba	30.00 TL



Oynar Bingo

Sadece Plastik	4.75 TL
25'lik M8 somun	17.00 TL



İçe Geçme Köşeli Tırnaklı Tapa (Kalın Plastik)

10x20 mm	250 Adet/torba	1.50 TL
15x15 mm	250 Adet/torba	1.50 TL
20x20 mm	250 Adet/torba	2.10 TL
20x30 mm	250 Adet/torba	1.95 TL
20x40 mm	250 Adet/torba	1.95 TL
20x60 mm	250 Adet/torba	3.62 TL
25x25 mm	250 Adet/torba	1.99 TL
30x30 mm	250 Adet/torba	2.00 TL
30x40 mm	250 Adet/torba	4.62 TL
30x50 mm	250 Adet/torba	4.62 TL
40x40 mm	250 Adet/torba	3.00 TL
40x60 mm	250 Adet/torba	8.10 TL
60x60 mm	250 Adet/torba	12.10 TL



İçe Geçme Yuvarlak Tırnaklı Tapa

16 mm	0.95 TL
19 mm	0.95 TL
21 mm	2.10 TL
25 mm	2.75 TL
32 mm	2.75 TL
48 mm	3.10 TL



İçe Geçme Oval Tırnaklı Tapa

15x30 mm	1.50 TL
20x40 mm	1.80 TL
25x50 mm	1.70 TL



İçe Geçme Yuvarlak Tapa

13 mm	250 Adet/torba	1.50 TL
16 mm	250 Adet/torba	1.70 TL
16 mm - 1.2	250 Adet/torba	1.50 TL
16 mm - 1.5	250 Adet/torba	1.50 TL
16 mm - 2.0	250 Adet/torba	2.00 TL
19 mm	250 Adet/torba	1.80 TL
21 mm	250 Adet/torba	1.80 TL
21 mm - 1.5	250 Adet/torba	2.50 TL
25 mm	250 Adet/torba	1.70 TL
27 mm	250 Adet/torba	4.90 TL
32 mm	250 Adet/torba	3.00 TL
38 mm	250 Adet/torba	4.20 TL
42 mm	250 Adet/torba	4.90 TL
45 mm	250 Adet/torba	4.00 TL
48 mm	250 Adet/torba	4.60 TL
51 mm	250 Adet/torba	5.00 TL
60 mm	250 Adet/torba	6.20 TL
100 mm	250 Adet/torba	22.00 TL



İçe Geçme Köşeli Eğik

30x30 mm	3.30 TL
----------	---------

Trafik Tapası

60 mm	27.00 TL
-------	----------



Lale Tapa

25 mm	15.00 TL
32 mm	18.00 TL



Oval Tapa

20x40 i açılı	11.00 TL
---------------	----------



Oval Tapa

15x30 iç oval eğik	2.75 TL
--------------------	---------



Flans

67 mm	4.30 TL
-------	---------



İçe Geçme Ezik Tapa

32 mm	5.25 TL
-------	---------



Dışa Geçme Ezik Tapa

32 mm	9.50 TL
-------	---------



Manyar Ayak

8.5 mm	3.80 TL
9 mm	3.80 TL
10 mm	4.00 TL
12 mm	4.60 TL
13 mm	5.00 TL
17 mm	8.00 TL



Ayarlı İçe Geçme Tapa

41 mm	19.00 TL
51 mm	25.00 TL
60 mm	30.00 TL



Baza Yatak Birleştirici

6.40 TL



Baza Denge Takozu

2.00 TL



Baza Yatak Tutucu (Denstop)

3.00 TL



Şeffaf Tırtırlı Mantar

9 mm	2.50 TL
11 mm	3.00 TL
13 mm	3.50 TL



Bingo Koltuk Ayak

No:1 - 3/8 - M10	13.00 TL
No:4 - 3/8 - M10	17.00 TL
No:5 - 3/8 - M10	18.00 TL



Pim Uç Tapa

No:3 - 7.5x17x14 mm 1.80 TL



Büyük Ağaç Vialı Ayak

18.00 TL



Baza Stoper Yuvarlak

2.20 TL



Lama Pabuç

8 mm - Şeffaf	2.50 TL
8 mm - Siyah	2.50 TL
10 mm - Şeffaf	3.80 TL
10 mm - Siyah	3.80 TL



Baston Ayağı

100 Adet/Torba 12.00 TL



Baza Yüzüğü

Kısa 2.20 TL
Uzun 2.20 TL



Ranza Ara Bağlantı Aparatı

19.00 TL



Baza Amortisör Emniyet Kilidi

Sağ Taraf 5.00 TL
Sol Taraf 5.00 TL



U Lama Altılık

10 mm 3.20 TL



Dışa Geçme Piknik Tapa

21 mm 3.60 TL
25 mm 10.00 TL



Huni Tapa

32 mm 16.00 TL



Petek Tapa

32 mm - 32x60 mm 19.00 TL



Dolap Altı Tapa

Küçük 7.00 TL
32-20.5-7.14 mm



Baza Kulbu

19.00 TL



Saç Kenar PVC Fitolu

100 mt top

8.5 ince	600.- TL/top
10 ince	640.- TL/top
8.5 kalın	650.- TL/top
10 kalın	800.- TL/top
11 kalın	1000.- TL/top
12 kalın	1100.- TL/top

Sac Kenar Fitolu

Yumuşak fitil, siyah 9.00 TL/mt
0.8 - 1.2 mm sac kalınlığı



PVC Fitolu İçi Dolu

100 mt top

3 mm	620.- TL/top
4 mm	700.- TL/top
5 mm	1100.- TL/top
6 mm	
8 mm	
10 mm	

PVC Fitolu İçi Boş

100 mt top

3 mm	600.- TL/top
4 mm	700.- TL/top
5 mm	1100.- TL/top
6 mm	
8 mm	
10 mm	



PVC Çatal Fitolu

100 mt top

Siyah	600.- TL/top
Renkli	800.- TL/top



2'li Fitolu PVC

50 mt top

berber büro koltukları için 1100.- TL/top



E Fitolu PVC

50 mt top

berber büro koltukları için 1250.- TL/top



Metal Sustalı Kol Cıvatalı Gri Boyalı - SMC

Ø 60 M6 x 20	86.00 TL
Ø 60 M6 x 25	86.00 TL
Ø 60 M6 x 30	86.00 TL
Ø 60 M6 x 40	90.00 TL
Ø 60 M6 x 50	96.00 TL
Ø 60 M8 x 20	86.00 TL
Ø 60 M8 x 25	86.00 TL
Ø 60 M8 x 30	86.00 TL
Ø 60 M8 x 40	90.00 TL
Ø 60 M8 x 50	96.00 TL
Ø 60 M10 x 20	90.00 TL
Ø 60 M10 x 25	90.00 TL
Ø 60 M10 x 30	90.00 TL
Ø 60 M10 x 40	96.00 TL
Ø 60 M10 x 50	99.00 TL
Ø 60 M12 x 30	99.00 TL
Ø 60 M12 x 40	106.00 TL
Ø 60 M12 x 50	112.00 TL
Ø 80 M6 x 20	106.00 TL
Ø 80 M6 x 25	106.00 TL
Ø 80 M6 x 30	106.00 TL
Ø 80 M6 x 40	111.00 TL
Ø 80 M6 x 50	117.00 TL
Ø 80 M8 x 20	106.00 TL
Ø 80 M8 x 25	106.00 TL
Ø 80 M8 x 30	106.00 TL
Ø 80 M8 x 40	117.00 TL
Ø 80 M8 x 50	117.00 TL
Ø 80 M10 x 20	106.00 TL
Ø 80 M10 x 25	106.00 TL
Ø 80 M10 x 30	106.00 TL
Ø 80 M10 x 40	111.00 TL
Ø 80 M10 x 50	117.00 TL
Ø 80 M12 x 30	111.00 TL
Ø 80 M12 x 40	117.00 TL
Ø 80 M12 x 50	120.00 TL



Metal Sustalı Kol Burçlu

Gri Boyalı - SMB

Ø 60 M6	79.00 TL
Ø 60 M8	79.00 TL
Ø 60 M10	79.00 TL
Ø 60 M12	86.00 TL
Ø 80 M6	86.00 TL
Ø 80 M8	86.00 TL
Ø 80 M10	86.00 TL
Ø 80 M12	82.00 TL



Plastik Sustalı Kol Cıvatalı

No :1 M6 x 30	53.00 TL
No :1 M8 x 20	53.00 TL
No :1 M8 x 32	53.00 TL
No :1 M8 x 40	53.00 TL
No :2 M10 x 25	55.00 TL
No :2 M10 x 35	55.00 TL
No :2 M10 x 40	55.00 TL
No :2 M10 x 50	60.00 TL
No :3 M12 x 60	70.00 TL



Plastik Sustalı Kol Burçlu

No :1 M8	52.00 TL
No :2 M8	52.00 TL
No :2 M10	52.00 TL
No :3 M10	52.00 TL
No :3 M12	60.00 TL



Metal Sustalı Kol Cıvatalı

Ø 60 M6 x 20	86.00 TL
Ø 60 M8 x 20	86.00 TL
Ø 60 M8 x 30	86.00 TL
Ø 60 M8 x 40	90.00 TL
Ø 80 M10 x 25	106.00 TL
Ø 80 M10 x 30	106.00 TL
Ø 80 M10 x 40	111.00 TL
Ø 80 M10 x 50	116.00 TL



Metal Sustalı Kol Burçlu

Ø 60 M6	79.00 TL
Ø 60 M8	79.00 TL
Ø 80 M8	86.00 TL
Ø 80 M10	86.00 TL
Ø 80 M12	92.00 TL



Polyamid Döner Kol

Ø 55 M6 x 15	53.00 TL
Ø 65 M8 x 18	56.00 TL
Ø 75 M10 x 15	60.00 TL
Ø 75 M12 x 15	66.00 TL



Kauçuk Taban Boyalı Makina Ayak - SLB

Ø 40 M8 x 50	86.00 TL
Ø 40 M10 x 50	93.00 TL
Ø 40 M10 x 100	99.00 TL
Ø 40 M12 x 50	93.00 TL
Ø 40 M12 x 100	99.00 TL
Ø 60 M10 x 50	120.00 TL
Ø 60 M10 x 100	126.00 TL
Ø 60 M12 x 50	120.00 TL
Ø 60 M12 x 100	126.00 TL
Ø 80 M16 x 100	145.00 TL
Ø 80 M12 x 50	185.00 TL
Ø 80 M12 x 100	199.00 TL
Ø 80 M14 x 100	211.00 TL
Ø 80 M16 x 100	211.00 TL
Ø 80 M16 x 150	225.00 TL
Ø 80 M16 x 200	265.00 TL
Ø 80 M20 x 100	239.00 TL
Ø 80 M20 x 150	265.00 TL
Ø 80 M20 x 200	277.00 TL
Ø 100 M12 x 100	239.00 TL
Ø 100 M14 x 100	265.00 TL
Ø 100 M16 x 100	265.00 TL
Ø 100 M16 x 150	292.00 TL
Ø 100 M16 x 200	305.00 TL
Ø 100 M20 x 100	277.00 TL
Ø 100 M20 x 150	302.00 TL
Ø 100 M20 x 200	330.00 TL
Ø 120 M12 x 100	330.00 TL
Ø 120 M14 x 100	344.00 TL
Ø 120 M16 x 100	344.00 TL
Ø 120 M16 x 150	371.00 TL
Ø 120 M16 x 200	397.00 TL
Ø 120 M20 x 100	371.00 TL
Ø 120 M20 x 150	397.00 TL
Ø 120 M20 x 200	423.00 TL
Ø 160 M16 x 100	529.00 TL
Ø 160 M16 x 150	556.00 TL
Ø 160 M16 x 200	608.00 TL
Ø 160 M20 x 100	556.00 TL
Ø 160 M20 x 150	608.00 TL
Ø 160 M20 x 200	661.00 TL
Ø 200 M16 x 100	900.00 TL
Ø 200 M16 x 150	925.00 TL
Ø 200 M20 x 100	925.00 TL
Ø 200 M20 x 150	966.00 TL

Krom Tezgah Tamponu - SL

Ø 40 M8 x 50	86.00 TL
Ø 40 M10 x 50	93.00 TL
Ø 40 M10 x 100	99.00 TL
Ø 40 M12 x 50	93.00 TL
Ø 40 M12 x 100	99.00 TL
Ø 60 M10 x 50	120.00 TL
Ø 60 M10 x 100	125.50 TL
Ø 60 M12 x 50	120.00 TL
Ø 60 M12 x 100	125.50 TL
Ø 60 M16 x 100	145.00 TL
Ø 80 M12 x 50	185.00 TL
Ø 80 M12 x 100	199.00 TL
Ø 80 M14 x 100	211.00 TL
Ø 80 M16 x 100	211.00 TL
Ø 80 M16 x 150	225.00 TL
Ø 80 M16 x 200	265.00 TL
Ø 80 M20 x 150	265.00 TL
Ø 80 M20 x 200	277.00 TL
Ø 100 M12 x 100	239.00 TL
Ø 100 M14 x 100	265.00 TL
Ø 100 M16 x 100	265.00 TL
Ø 100 M16 x 150	292.00 TL
Ø 100 M16 x 200	305.00 TL
Ø 100 M20 x 100	277.00 TL
Ø 100 M20 x 150	305.00 TL
Ø 100 M20 x 200	330.00 TL
Ø 120 M12 x 100	330.00 TL
Ø 120 M16 x 100	344.00 TL
Ø 120 M16 x 150	371.00 TL
Ø 120 M16 x 200	397.00 TL
Ø 120 M20 x 100	371.00 TL
Ø 120 M20 x 150	397.00 TL
Ø 120 M20 x 200	423.00 TL
Ø 160 M16 x 100	529.00 TL
Ø 160 M16 x 150	556.00 TL
Ø 160 M16 x 200	608.00 TL
Ø 160 M20 x 100	556.00 TL
Ø 160 M20 x 150	608.00 TL
Ø 160 M20 x 200	661.00 TL
Ø 200 M16 x 100	900.00 TL
Ø 200 M16 x 150	925.00 TL
Ø 200 M20 x 100	925.00 TL
Ø 200 M20 x 150	966.00 TL



Tezgah Tamponu Somunlu - SH

Ø 80 M12 x 120	265.00 TL
Ø 80 M16 x 140	278.00 TL
Ø 120 M12 x 140	397.00 TL
Ø 120 M16 x 140	397.00 TL
Ø 160 M16 x 210	632.00 TL
Ø 160 M20 x 170	661.00 TL
Ø 200 M20 x 170	1110.00 TL
Ø 200 M24 x 170	1163.00 TL
Ø 240 M30 x 200	1983.00 TL



Kauçuk Taban Saç Gövde Mafsallı Tezgah Tamponu - SMHB

Ø 80 M12 x 100	305.00 TL
Ø 80 M16 x 100	305.00 TL
Ø 80 M16 x 150	318.00 TL
Ø 80 M20 x 100	318.00 TL
Ø 80 M20 x 150	331.00 TL
Ø 100 M12 x 100	344.00 TL
Ø 100 M16 x 100	344.00 TL
Ø 100 M16 x 150	371.00 TL
Ø 100 M20 x 100	371.00 TL
Ø 100 M20 x 150	397.00 TL
Ø 120 M12 x 100	423.00 TL
Ø 120 M16 x 100	450.00 TL
Ø 120 M16 x 150	450.00 TL
Ø 120 M20 x 100	450.00 TL
Ø 120 M20 x 150	475.00 TL
Ø 160 M16 x 100	608.00 TL
Ø 160 M16 x 150	635.00 TL
Ø 160 M20 x 100	635.00 TL
Ø 160 M20 x 150	661.00 TL





Polyamid Tabanlı Mafsallı Ayak SP Serisi

Ø 60 M12 x 100	120.00 TL
Ø 60 M12 x 150	140.00 TL
Ø 60 M16 x 60	96.00 TL
Ø 60 M16 x 100	104.00 TL
Ø 60 M16 x 150	120.00 TL
Ø 60 M16 x 200	146.00 TL
Ø 60 M20 x 100	117.00 TL
Ø 60 M20 x 150	132.00 TL
Ø 60 M20 x 200	160.00 TL
Ø 80 M12 x 100	120.00 TL
Ø 80 M12 x 150	145.00 TL
Ø 80 M16 x 60	103.00 TL
Ø 80 M16 x 100	103.00 TL
Ø 80 M16 x 150	111.00 TL
Ø 80 M16 x 200	160.00 TL
Ø 80 M20 x 100	122.00 TL
Ø 80 M20 x 150	145.00 TL
Ø 80 M20 x 200	173.00 TL
Ø 80 M24 x 200	239.00 TL
Ø 110 M12 x 100	132.00 TL
Ø 110 M16 x 60	106.00 TL
Ø 110 M16 x 100	114.00 TL
Ø 110 M16 x 150	128.00 TL
Ø 110 M16 x 200	173.00 TL
Ø 110 M20 x 100	132.00 TL
Ø 110 M20 x 150	145.00 TL
Ø 110 M20 x 200	185.00 TL
Ø 110 M24 x 200	265.00 TL



Çelik Tabanlı Cıvatalı Mafsallı Krom Kaplı Ayak - CM Serisi

Ø 60 M12 x 80	213.00 TL
Ø 60 M16 x 60	252.00 TL
Ø 60 M16 x 100	265.00 TL
Ø 60 M16 x 150	292.00 TL
Ø 80 M12 x 100	358.00 TL
Ø 80 M12 x 150	384.00 TL
Ø 80 M16 x 60	331.00 TL
Ø 80 M16 x 100	358.00 TL
Ø 80 M16 x 150	371.00 TL
Ø 80 M16 x 200	384.00 TL
Ø 80 M20 x 100	371.00 TL
Ø 80 M20 x 150	397.00 TL
Ø 80 M20 x 200	424.00 TL
Ø 100 M12 x 100	450.00 TL
Ø 100 M12 x 150	477.00 TL
Ø 100 M16 x 60	424.00 TL
Ø 100 M16 x 100	450.00 TL
Ø 100 M16 x 150	477.00 TL
Ø 100 M16 x 200	503.00 TL
Ø 100 M20 x 100	477.00 TL
Ø 100 M20 x 150	503.00 TL
Ø 100 M20 x 200	529.00 TL
Ø 100 M24 x 200	661.00 TL
Ø 120 M16 x 100	608.00 TL
Ø 120 M16 x 150	635.00 TL
Ø 120 M16 x 200	661.00 TL
Ø 120 M20 x 100	635.00 TL
Ø 120 M20 x 150	661.00 TL
Ø 120 M20 x 200	700.00 TL
Ø 120 M24 x 200	727.00 TL



Uzun Gövde

64x55 mm - M8

34.00 TL

64x55 mm - M10

34.00 TL

Yıldız Kelebek Sap

80x45 M16x30

55.00 TL



Matkap Kolu

No:10 - 83 mm

15.00 TL

No:12 - 83 mm

15.00 TL

No:16 - 83 mm

20.00 TL

100 Adet/torba



PVC Kol

25x115 mm

23.00 TL

25 Adet/torba

PVC Yassı Kol

30x10x100 mm

13.00 TL



Planya Kolu

No:1 - 25x63 mm, 9 mm 12.00 TL

No:2 - 28x85 mm, 9 mm 15.00 TL

25 Adet/torba



Köşebent Tapa

30 mm

25 Adet/torba

4.75 TL

40 mm

25 Adet/torba

4.75 TL



Plastik Kelebek Somun Tapa

M6

2.25 TL

5/16

2.25 TL



Bakalit Tutamak M6



Polyamid Tabanlı Mafsallı Ayak Hafif Tip

Ø 50 M6 x 30	44.00 TL
Ø 50 M8 x 50	44.00 TL
Ø 50 M10 x 50	44.00 TL
Ø 50 M12 x 50	44.00 TL
Ø 60 M8 x 50	50.00 TL
Ø 60 M8 x 80	56.00 TL
Ø 60 M10 x 50	50.00 TL
Ø 60 M10 x 80	56.00 TL
Ø 60 M12 x 50	62.00 TL
Ø 60 M12 x 80	56.00 TL
Ø 80 M8 x 50	53.00 TL
Ø 80 M8 x 80	60.00 TL
Ø 80 M10 x 50	53.00 TL
Ø 80 M10 x 80	60.00 TL
Ø 80 M12 x 50	53.00 TL
Ø 80 M12 x 80	60.00 TL





Kelebek Saplarda (Erkek)

Ø 20x25 M6x15	11.80 TL
Ø 30x26 M6x15	13.85 TL
Ø 30x26 M8x20	14.60 TL
Ø 40x29 M6x20	15.25 TL
Ø 40x29 M8x20	17.25 TL
Ø 40x29 M10x25	17.90 TL
Ø 50x32 M8x25	26.50 TL
Ø 50x32 M10x30	29.10 TL
Ø 50x32 M12x25	33.00 TL
Ø 63x38 M8x30	33.00 TL
Ø 63x38 M10x30	34.40 TL
Ø 63x38 M12x30	39.65 TL
Ø 70x40 M10x30	46.25 TL
Ø 70x40 M12x45	49.50 TL



Silindir Saplarda (Erkek)

Ø 18x40 M6x15	20.65 TL
Ø 21x50 M8x15	24.50 TL
Ø 21x50 M10x15	26.50 TL
Ø 23x65 M8x20	27.80 TL
Ø 23x65 M10x20	32.00 TL
Ø 26x80 M10x25	34.35 TL
Ø 26x80 M12x25	41.00 TL
Ø 28x90 M10x25	42.30 TL
Ø 28x90 M12x25	50.25 TL



Plastik Profil Boru Kulp

PBK 1 - 200x20	79.00 TL
PBK 1 - 300x20	91.00 TL
PBK 1 - 400x20	103.00 TL
PBK 1 - 500x20	114.00 TL
PBK 1 - 600x20	124.00 TL
PBK 2 - 200x25	97.00 TL
PBK 2 - 300x25	110.00 TL
PBK 2 - 400x25	112.00 TL
PBK 2 - 500x25	137.00 TL
PBK 2 - 600x25	150.00 TL
PBK 3 - 200x30	135.00 TL
PBK 3 - 300x30	162.00 TL
PBK 3 - 400x30	189.00 TL
PBK 3 - 500x30	218.00 TL
PBK 3 - 600x30	242.00 TL



Silindir Saplarda (Dişi)

Ø 18x40 M6	22.70 TL
Ø 21x50 M8	26.45 TL
Ø 21x50 M10	31.10 TL
Ø 23x65 M8	32.20 TL
Ø 23x65 M10	35.05 TL
Ø 26x80 M10	41.00 TL
Ø 26x80 M12	43.60 TL
Ø 28x90 M10	47.65 TL
Ø 28x90 M12	50.20 TL



Kelebek Saplarda (Dişi)

Ø 20x25 M6x11	12.30 TL
Ø 30x26 M6x11	13.20 TL
Ø 30x26 M8x15	14.60 TL
Ø 40x29 M6x11	17.25 TL
Ø 40x29 M8x15	18.25 TL
Ø 40x29 M10x17	18.90 TL
Ø 50x32 M8x15	28.80 TL
Ø 50x32 M10x17	29.75 TL
Ø 50x32 M12x22	31.65 TL
Ø 63x38 M8x15	37.75 TL
Ø 63x38 M10x17	38.35 TL
Ø 63x38 M12x22	41.00 TL
Ø 70x40 M10x17	52.85 TL
Ø 70x40 M12x22	54.22 TL



Volant Kolları Cam Elyaflı Kolsuz

100 mm	152.00 TL
125 mm	182.00 TL
150 mm	239.00 TL
175 mm	344.00 TL
200 mm	384.00 TL



Rotil Ayak Üst

25x25 M8	9.90 TL
30x30 M10	11.20 TL
30x40 M10	13.25 TL
40x40 M10	13.25 TL
40x40 M12	17.25 TL
40x40M16	26.45 TL
40x60M12	11.50 TL
60x60M16	44.85 TL



Rotil Ayak Alt

35 mm - M8 x 35	12.60 TL
35 mm - M10 x 35	15.80 TL
45 mm - M10 x 35	22.50 TL
45 mm - M12 x 40	29.10 TL

Rotil Ayak Takımı

25x25 mm - M8	14.60 TL
30x30 mm - M10	17.10 TL
30x40 mm - M10	21.25 TL
40x40 mm - M10	23.50 TL
40x40 mm - M12	27.75 TL
40x40 mm - M16	60.00 TL
50x50 mm - M16	68.50 TL



Plastik Boru Kulp

Cam Elyaf katkılı plastik	
PBKP 1 - Ø 20	23.10 TL
PBKP 2 - Ø 25	29.50 TL
PBKP 3 - Ø 30	34.60 TL



Bakalit Tutamak

No : 1 -132x109 mm	61.25 TL
No : 2 -165x131 mm	72.70 TL



Logo Tutamak

42 x 146 mm	49.00 TL
-------------	----------



Plastik Tutamak

No : 1 - 120 mm	11.80 TL
No : 2 - 138 mm	14.60 TL



A Tipi Lastik Takoz	Pullu	Pulsuz
A 10 x 10 - M4	13.46 TL	-
A 15 x 10 - M4	14.00 TL	-
A 15 x 15 - M4	14.92 TL	11.93 TL
A 20 x 15 - M6	15.29 TL	10.70 TL
A 20 x 20 - M6	15.83 TL	11.09 TL
A 25 x 10 - M6	16.97 TL	-
A 25 x 20 - M6	17.89 TL	12.51 TL
A 30 x 20 - M8	21.72 TL	15.20 TL
A 30 x 30 - M8	23.02 TL	16.12 TL
A 40 x 20 - M8	28.10 TL	-
A 40 x 30 - M8	30.53 TL	21.38 TL
A 40 x 40 - M8	32.97 TL	23.06 TL
A 40 x 50 - M8	40.75 TL	28.52 TL
A 50 x 10 - M10	40.75 TL	-
A 50 x 20 - M10	44.26 TL	-
A 50 x 30 - M10	47.88 TL	33.51 TL
A 50 x 40 - M10	51.72 TL	36.19 TL
A 50 x 50 - M10	55.45 TL	38.82 TL
A 50 x 35 - M10	49.61 TL	34.74 TL
A 60 x 20 - M10	63.82 TL	-
A 60 x 30 - M10	69.17 TL	-
A 60 x 35 - M10	71.66 TL	-
A 60 x 40 - M10	74.36 TL	52.07 TL
A 60 x 50 - M10	79.66 TL	53.77 TL
A 60 x 60 - M10	90.25 TL	63.18 TL
A 70 x 30 - M12	107.33 TL	75.13 TL
A 70 x 40 - M12	114.30 TL	80.02 TL
A 70 x 50 - M12	121.32 TL	84.92 TL
A 70 x 60 - M12	127.22 TL	89.06 TL
A 70 x 70 - M12	146.24 TL	102.36 TL
A 75 x 40 - M12	120.78 TL	84.56 TL
A 75 x 50 - M12	128.73 TL	90.12 TL
A 75 x 60 - M12	136.73 TL	95.71 TL
A 80 x 40 - M12	135.21 TL	94.65 TL
A 80 x 50 - M12	144.40 TL	101.08 TL
A 80 x 60 - M12	153.64 TL	107.54 TL
A 80 x 80 - M12	177.47 TL	124.33 TL
A 90 x 55 - M16	198.55 TL	-
A 100 x 40 - M16	233.79 TL	163.66 TL
A 100 x 50 - M16	248.16 TL	173.71 TL
A 100 x 55 - M16	255.35 TL	178.76 TL
A 100 x 60 - M16	262.59 TL	-
A 100 x 65 - M16	269.78 TL	-
A 100 x 75 - M16	284.15 TL	-
A 100 x 100 - M16	484.27 TL	338.99 TL
A 120 x 40 - M16	321.33 TL	224.85 TL
A 120 x 60 - M16	362.08 TL	-
A 130 x 50 - M16	468.33 TL	-
A 130 x 60 - M16	564.33 TL	395.26 TL
A 140 x 50 - M20	824.74 TL	-
A 140 x 70 - M20	880.24 TL	-
A 150 x 50 - M20	778.80 TL	545.15 TL
A 150 x 100 - M20	1405.10 TL	-
A 200 x 100 - M20	1796.52 TL	1257.57 TL

A Tipi Lastik Takoz Pullu
A 30x20 M8 - 8 Adet Set 190.24 TL
16 adet M8 somunla beraber flaşlı

B Tipi Lastik Takoz	
B 10 x 10 - M4	14.05 TL
B 15 x 10 - M4	14.59 TL
B 15 x 15 - M4	15.40 TL
B 20 x 15 - M6	18.32 TL
B 20 x 20 - M6	18.86 TL
B 25 x 10 - M6	19.42 TL
B 25 x 20 - M6	20.48 TL

B 30 x 20 - M8	24.92 TL
B 30 x 25 - M8	25.99 TL
B 30 x 30 - M8	27.18 TL

B 40 x 20 - M8	33.18 TL
B 40 x 30 - M8	35.61 TL
B 40 x 40 - M8	37.88 TL
B 40 x 50 - M8	45.72 TL

B 50 x 10 - M10	45.23 TL
B 50 x 20 - M10	48.75 TL
B 50 x 30 - M10	52.85 TL
B 50 x 40 - M10	56.31 TL
B 50 x 50 - M10	60.20 TL
B 50 x 35 - M10	54.37 TL

B 60 x 20 - M10	68.20 TL
B 60 x 30 - M10	73.17 TL
B 60 x 35 - M10	75.93 TL
B 60 x 40 - M10	78.58 TL
B 60 x 50 - M10	83.87 TL
B 60 x 60 - M10	94.63 TL

B 70 x 30 - M12	113.97 TL
B 70 x 40 - M12	121.00 TL
B 70 x 50 - M12	127.97 TL
B 70 x 60 - M12	135.05 TL
B 70 x 70 - M12	152.89 TL

B 75 x 40 - M12	131.32 TL
B 75 x 50 - M12	139.48 TL
B 75 x 60 - M12	147.70 TL

B 80 x 40 - M12	141.70 TL
B 80 x 50 - M12	150.99 TL
B 80 x 60 - M12	160.24 TL
B 80 x 80 - M12	189.12 TL

B 90 x 55 - M16	212.71 TL
-----------------	-----------

B 100 x 40 - M16	229.30 TL
B 100 x 50 - M16	243.68 TL
B 100 x 55 - M16	250.76 TL
B 100 x 65 - M16	265.19 TL
B 100 x 75 - M16	279.56 TL
B 100 x 100 - M16	477.19 TL
B 120 x 40 - M16	314.15 TL
B 120 x 60 - M16	354.95 TL
B 130 x 50 - M16	478.33 TL
B 130 x 60 - M16	573.98 TL

B 140 x 50 - M20	814.52 TL
B 140 x 70 - M20	870.13 TL
B 150 x 50 - M20	795.07 TL
B 150 x 100 - M20	1432.12 TL
B 200 x 100 - M20	1764.96 TL

C Tipi Lastik Takoz	
C 10 x 10 - M4	14.59 TL
C 15 x 10 - M4	15.40 TL
C 15 x 15 - M4	16.21 TL
C 20 x 15 - M6	19.73 TL
C 20 x 20 - M6	20.16 TL
C 25 x 10 - M6	23.94 TL
C 25 x 20 - M6	24.91 TL

C 30 x 20 - M8	28.53 TL
C 30 x 30 - M8	27.92 TL

C 40 x 20 - M8	37.29 TL
C 40 x 30 - M8	39.45 TL
C 40 x 40 - M8	41.67 TL
C 40 x 50 - M8	49.66 TL

C 50 x 10 - M10	49.61 TL
C 50 x 20 - M10	53.18 TL
C 50 x 30 - M10	56.80 TL
C 50 x 40 - M10	60.37 TL
C 50 x 50 - M10	63.99 TL
C 50 x 35 - M10	58.53 TL

C 60 x 20 - M10	72.74 TL
C 60 x 30 - M10	78.10 TL
C 60 x 35 - M10	80.85 TL
C 60 x 40 - M10	83.55 TL
C 60 x 50 - M10	88.79 TL
C 60 x 60 - M10	99.55 TL

C 70 x 30 - M12	120.46 TL
C 70 x 40 - M12	127.54 TL
C 70 x 50 - M12	134.57 TL
C 70 x 60 - M12	141.54 TL
C 70 x 70 - M12	159.42 TL

C 75 x 40 - M12	127.27 TL
C 75 x 50 - M12	135.43 TL
C 75 x 60 - M12	143.37 TL

C 80 x 40 - M12	148.40 TL
C 80 x 50 - M12	157.64 TL
C 80 x 60 - M12	166.77 TL
C 80 x 80 - M12	190.71 TL

C 90 x 55 - M16	212.71 TL
-----------------	-----------

C 100 x 40 - M16	222.22 TL
C 100 x 50 - M16	236.65 TL
C 100 x 55 - M16	243.84 TL
C 100 x 65 - M16	258.27 TL
C 100 x 75 - M16	272.53 TL
C 100 x 100 - M16	467.84 TL
C 120 x 40 - M16	307.23 TL
C 120 x 60 - M16	348.03 TL
C 130 x 60 - M16	583.22 TL

C 140 x 50 - M20	826.20 TL
C 140 x 70 - M20	881.81 TL
C 150 x 50 - M20	811.39 TL
C 150 x 100 - M20	1405.10 TL
C 200 x 100 - M20	1752.10 TL

**D Tipi Lastik Takoz**

Pullu	Pulsuz
D 10 x 10 - M4	10.81 TL
D 15 x 10 - M4	11.55 TL
D 15 x 15 - M4	12.29 TL
D 20 x 15 - M6	13.19 TL
D 20 x 20 - M6	13.62 TL
D 25 x 10 - M6	14.91 TL
D 25 x 20 - M6	16.25 TL
D 30 x 20 - M8	18.71 TL
D 30 x 30 - M8	20.13 TL
D 40 x 20 - M8	21.78 TL
D 40 x 30 - M8	24.05 TL
D 40 x 40 - M8	26.48 TL
D 40 x 50 - M8	34.37 TL
D 50 x 10 - M10	28.47 TL
D 50 x 20 - M10	32.53 TL
D 50 x 30 - M10	36.15 TL
D 50 x 40 - M10	39.61 TL
D 50 x 50 - M10	43.23 TL
D 50 x 35 - M10	37.88 TL
D 60 x 20 - M10	47.29 TL
D 60 x 30 - M10	52.64 TL
D 60 x 35 - M10	55.34 TL
D 60 x 40 - M10	58.04 TL
D 60 x 50 - M10	63.39 TL
D 60 x 60 - M10	74.15 TL
D 70 x 30 - M12	79.66 TL
D 70 x 40 - M12	86.63 TL
D 70 x 50 - M12	93.71 TL
D 70 x 60 - M12	100.73 TL
D 70 x 70 - M12	118.57 TL
D 75 x 50 - M12	105.22 TL
D 75 x 60 - M12	113.60 TL
D 80 x 40 - M12	105.92 TL
D 80 x 50 - M12	115.16 TL
D 80 x 60 - M12	124.35 TL
D 80 x 80 - M12	143.59 TL
D 90 x 55 - M16	172.39 TL
D 100 x 40 - M16	173.26 TL
D 100 x 50 - M16	187.63 TL
D 100 x 55 - M16	194.71 TL
D 100 x 65 - M16	209.14 TL
D 100 x 75 - M16	223.63 TL
D 100 x 100 - M16	428.93 TL
D 120 x 40 - M16	258.54 TL
D 120 x 60 - M16	299.45 TL
D 130 x 50 - M16	379.59 TL
D 130 x 60 - M16	455.52 TL
D 140 x 50 - M20	582.63 TL
D 140 x 70 - M20	638.13 TL
D 150 x 50 - M20	540.26 TL
D 150 x 100 - M20	1026.90 TL
D 200 x 100 - M20	1418.23 TL

Pulsuz**E Tipi Lastik Takoz**

E 10 x 10 - M4	11.89 TL
E 15 x 10 - M4	12.16 TL
E 15 x 15 - M4	13.24 TL
E 20 x 15 - M6	14.59 TL
E 20 x 20 - M6	15.13 TL
E 25 x 10 - M6	15.37 TL
E 25 x 20 - M6	16.54 TL
E 30 x 20 - M8	20.62 TL
E 30 x 30 - M8	21.98 TL
E 40 x 20 - M8	25.83 TL
E 40 x 30 - M8	28.10 TL
E 40 x 40 - M8	30.53 TL
E 40 x 50 - M8	38.37 TL
E 50 x 10 - M10	33.40 TL
E 50 x 20 - M10	37.29 TL
E 50 x 30 - M10	40.75 TL
E 50 x 40 - M10	44.25 TL
E 50 x 50 - M10	47.88 TL
E 50 x 35 - M10	42.53 TL
E 60 x 20 - M10	51.77 TL
E 60 x 30 - M10	57.07 TL
E 60 x 35 - M10	59.82 TL
E 60 x 40 - M10	62.53 TL
E 60 x 50 - M10	67.88 TL
E 60 x 60 - M10	78.58 TL
E 70 x 30 - M12	86.20 TL
E 70 x 40 - M12	93.22 TL
E 70 x 50 - M12	100.19 TL
E 70 x 60 - M12	107.33 TL
E 70 x 70 - M12	125.11 TL
E 75 x 40 - M12	100.41 TL
E 75 x 50 - M12	108.35 TL
E 75 x 60 - M12	116.62 TL
E 80 x 40 - M12	112.57 TL
E 80 x 50 - M12	121.81 TL
E 80 x 60 - M12	131.00 TL
E 80 x 80 - M12	150.24 TL
E 90 x 55 - M16	179.53 TL
E 100 x 40 - M16	168.61 TL
E 100 x 50 - M16	183.04 TL
E 100 x 55 - M16	190.23 TL
E 100 x 65 - M16	204.60 TL
E 100 x 75 - M16	219.03 TL
E 100 x 100 - M16	391.21 TL
E 120 x 40 - M16	251.46 TL
E 120 x 60 - M16	292.26 TL
E 130 x 50 - M16	387.27 TL
E 130 x 60 - M16	464.76 TL
E 140 x 50 - M20	594.30 TL
E 140 x 70 - M20	649.80 TL
E 150 x 50 - M20	556.53 TL
E 150 x 100 - M20	1080.84 TL
E 200 x 100 - M20	1396.02 TL

Armut Tipi Lastik Takoz

35x35 - M8x18	37.83 TL
100x95 - M16x42	324.25 TL
95x83 - M16x42	297.23 TL
52x28 - M10x28	62.16 TL
60x60 - M12x37	91.87 TL
30x36 - M8x18	40.55 TL
30x30 - M8x18	35.14 TL
45x45 - M10x28	64.85 TL
70x60 - M12x37	87.28 TL
23x25 - M8x10	37.83 TL
25x16 - M6x18	32.43 TL
50x60 - M10x28	75.66 TL
16x16 - M6x18	27.02 TL
125x100 - M16x42	486.38 TL
50x58 - M8x18	64.15 TL

**Kesik Armut Tipi Lastik Takoz**

25x10 - M8x18	16.21 TL
22x14 - M6x16	17.57 TL
15x10 - M6x16	20.52 TL
20x20 - M6x18	24.33 TL
43x55 - M10x18	75.66 TL

**Gramaj Lastik Takoz Yuvarlak**

Ø 200 x H10	64.85 TL
Ø 115 x H15	35.14 TL

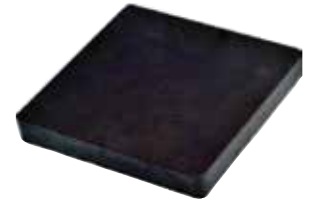
**Gramaj Lastik Takoz Kare**

215 x 215 - H10	94.59 TL
410 x 410 - H10	351.27 TL

**Fiçı Tipi Kaplin**

27 x 40 x 51	64.85 TL
38 x 60 x 75	243.19 TL
17 x 27 x 33	35.14 TL
22 x 37 x 43	54.04 TL
22 x 34 x 44	54.04 TL
49 x 78 x 97	373.30 TL
34 x 47 x 56	135.11 TL
14 x 25 x 30	32.43 TL
22 x 35 x 42	40.55 TL
15 x 26 x 32	32.43 TL



Kare Lastik Takozu

100x100x50	118.89 TL
100x150x50	1183.74 TL
150x150x30	162.13 TL
300x300x30	648.51 TL
400x400x40	1540.20 TL



Silindir Lastik Takozu

30x100	32.43 TL
40x100	28.92 TL
50x100	67.57 TL
60x100	97.28 TL
70x100	118.89 TL
80x100	151.32 TL
90x100	167.53 TL
100x100	186.46 TL



Kauçuk Sandal Takoz

Ø 80 x 125	189.15 TL
Ø 100 x 155	216.18 TL



Kauçuk Gromet Takoz (Geçit Lastiği)

10x16, h:7.5, Ø15 mm	14.53 TL
23x37, h:8, Ø32 mm	14.53 TL
30x50, h:12, Ø40 mm	26.64 TL
9.5x22, h:7.5, Ø16 mm	13.29 TL
8.5x17, h:15, Ø14 mm	10.93 TL
10x30, h:10, Ø25 mm	18.16 TL
7.5x22, h:15, Ø18 mm	14.53 TL
6.4x25, h:8.5, Ø18 mm	12.11 TL
9x17, h:18, Ø13 mm	14.53 TL
8x23, h:13, Ø18 mm	13.29 TL
11x23, h:10, Ø18 mm	18.16 TL
27x40, h:10, Ø33 mm	24.22 TL
13x36, h:10, Ø25 mm	19.34 TL
10x18, h:7, Ø15 mm	9.69 TL
18x29, h:13, Ø24 mm	20.58 TL
19x38, h:13, Ø27 mm	21.76 TL
8.6x17, h:8, Ø10 mm	9.69 TL
20x42/30, h:10, Ø25 mm	20.58 TL
13x25, h:10,	9.51 TL
15x30, h:10, Ø22 mm	18.37 TL
45x64, h:16, Ø52 mm	82.69 TL
60x90, h:10, Ø73 mm	91.87 TL
13x24/21, h:9, Ø20 mm	12.17 TL
40x60, h:15, Ø49 mm	59.45 TL



Küçük Kamyon Kasa Takozu

235 x 245 mm	226.99 TL
270 x 290 mm	308.06 TL



Kauçuk Terazı Ayak Takozu

Ø 27 x 10 - M6	8.13 TL
Ø 50 x 17 - M10	13.53 TL
Ø 70 x 18 - M12	18.91 TL



Kauçuk Dayama Lastik Takoz

21x27 - d:5.5, h 12	11.34 TL
30x43 - d:7, h 30	25.95 TL
30x32 - d:6, h 24	20.00 TL
22x26 - d:4, h 15	12.97 TL
30x45 - d:8, h 50	32.43 TL



Kauçuk Konik Vibrasyon Takozu

50x70, h:40, M10	70.25 TL
70x90, h:50, M10	102.68 TL
90x140, h:70, M12	216.17 TL
80x100, h:50, M12	118.89 TL
100x170, h:100, M20	432.34 TL
100x150, h:100, M16	351.27 TL
100x150, h:65, M16	243.19 TL
85x105, h:50, M20	135.11 TL



AT Tipi (Makara) Lastik Takoz

AT 25x10, h:20, M6x18	32.43 TL
AT 30x15, h:20, M6x18	35.14 TL
AT 43x27, h:25, M8x18	51.35 TL
AT 80x65, h:60, M12x37	151.32 TL
AT 110x56, h:60, M16x47	270.26 TL
AT 30x22, h:20, M8x18	37.83 TL
AT 95x80, h:80, M16x47	297.20 TL



Cıvatalı Kauçuk Kare Takoz

M12x33, 90x70	124.29 TL
---------------	-----------

Cıvatalı Kauçuk Kare Takoz

M12x33, 110x90	259.40 TL
----------------	-----------



Kilit Mandalı Burçlu

Cam Elyaf Katkılıdır.

No : 1 M4 x 22	7.15 TL
No : 1 M5 x 22	7.15 TL
No : 2 M5 x 27	7.80 TL
No : 2 M6 x 27	8.45 TL
No : 3 M6 x 35	9.10 TL
No : 3 M8 x 35	9.10 TL



Kilit Mandalı Cıvatalı

Cam Elyaf Katkılıdır.

No : 1 M4 x 10	7.15 TL
No : 1 M4 x 15	7.15 TL
No : 1 M5 x 10	7.15 TL
No : 1 M5 x 15	7.80 TL
No : 2 M5 x 15	7.80 TL
No : 2 M5 x 20	7.80 TL
No : 2 M6 x 15	7.80 TL
No : 2 M6 x 20	9.10 TL
No : 3 M6 x 20	9.10 TL
No : 3 M6 x 25	9.10 TL
No : 3 M6 x 30	9.10 TL



Tırtırlı Düşme Burçlu

Cam Elyaf Katkılıdır.

No : 1 M4 x 15	8.45 TL
No : 1 M5 x 15	8.45 TL
No : 1 M6 x 15	8.45 TL
No : 2 M5 x 20	9.75 TL
No : 2 M6 x 20	9.75 TL
No : 2 M8 x 20	9.75 TL
No : 3 M6 x 25	11.05 TL
No : 3 M8 x 25	11.05 TL
No : 3 M10 x 25	14.95 TL



Tırtırlı Düşme Cıvatalı

Cam Elyaf Katkılıdır.

No : 1 M4 x 10	8.45 TL
No : 1 M4 x 20	8.45 TL
No : 1 M5 x 10	8.45 TL
No : 1 M5 x 20	8.45 TL
No : 1 M6 x 10	8.45 TL
No : 1 M6 x 20	8.45 TL
No : 2 M5 x 15	9.75 TL
No : 2 M5 x 25	9.75 TL
No : 2 M6 x 15	9.75 TL
No : 2 M6 x 25	9.75 TL
No : 2 M6 x 30	9.75 TL
No : 2 M8 x 15	9.75 TL
No : 2 M8 x 25	9.75 TL
No : 3 M6 x 20	11.05 TL
No : 3 M6 x 30	11.05 TL
No : 3 M8 x 20	11.05 TL
No : 3 M8 x 30	11.05 TL
No : 3 M10 x 20	11.05 TL
No : 3 M10 x 30	11.05 TL

**Yaylı Vidalı Klips**

M4	0.23 \$
M5	0.21 \$
M6	0.23 \$
M8	0.40 \$

**Vida Sürümlü Sac Klips**

3.5 mm	0.052 \$
3.9 mm	0.052 \$

**Küp Mentеше**

8 mm x 8 mm M6	59.50 TL
10 mm x 10 mm M6	79.25 TL
12 mm x 12 mm M8	132.00 TL

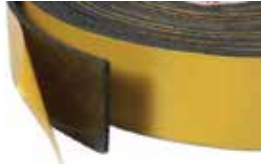
**Yapışkanlı Sünger Bant**

10x10x5 mm	52.90 TL/top
15x10x5 mm	79.40 TL/top
20x10x5 mm	106.00 TL/top
30x10x5 mm	159.00 TL/top
40x10x5 mm	212.00 TL/top
50x10x5 mm	265.00 TL/top

**Plastik Vida Klips**

Ø8 mm	2.20 TL
-------	---------

**Çark Kolu**

26x86 mm - M10	91.00 TL
26x86 mm - M12	91.00 TL

Katlanır Çark Kolu

26x86 mm - M10	145.00 TL
26x86 mm - M12	145.00 TL

**Metal Katlanır Çark Kolu**

60 mm M6x13 mm	172.00 TL
65 mm M8x15 mm	172.00 TL
75 mm M10x15 mm	198.00 TL
75 mm M12x15 mm	198.00 TL

**Tırnak Volant**

45 mm	86.00 TL
65 mm	119.00 TL
80 mm	152.00 TL
100 mm	206.00 TL
125 mm	429.00 TL

**Düz Volant**

Bakalit Cam Elyaf	
100 mm	169.00 TL
125 mm	225.00 TL
150 mm	291.00 TL
175 mm	350.00 TL
200 mm	377.00 TL

Volant kolları kolsuz satılır. Talebe göre silindirik saplardan verilir.

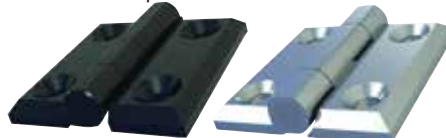
**Yaprak Mentеше (Statik Boya)**

40x40, 452	42.25 TL
50x50, 460	66.00 TL
60x60	119.00 TL

Yaprak Mentеше (Krom)

30x30	29.90 TL
40x40, 454	42.25 TL
50x50, 462	66.00 TL
60x60	119.00 TL

Yaprak Mentеше Cıvatalı (Krom)

40x40	62.00 TL
50x50	95.00 TL

**Plastik Mentеше Cam Elyaf Katkılı**

30 mm	12.55 TL
40 mm	19.80 TL
50 mm	29.00 TL
75 mm	70.00 TL
100 mm	79.00 TL

**Yük Taşıyıcı Makara**

(Alüminyum dahil) 475.00 TL/metre
20 mm yükseklik, 50 mm genişlik

**Masif Palet**

35x80 cm	76.00 TL
----------	----------

**Masif Palet**

58x68 cm	76.00 TL
----------	----------

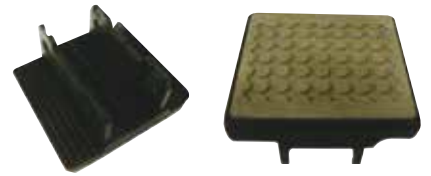
**Geniş Masif Palet**

70x80 cm	76.00 TL
----------	----------

**Masif Palet Takım Tekerleği**

20x70 cm	
----------	--

**Kenar Bantlama Makinası Paleti**

61x80 cm	76.00 TL
----------	----------

**Tırtırlı Üst Baskı Kauçuk Teker**

(Plastik gövde) 76.00 TL
70x24 mm, 21 mm delik ölçüsü

**Tetikli Kol**

19 mm çap, 120 mm boy	38.00 TL
-----------------------	----------

**İndeksleme Pistonu**

30 mm çap, 28 mm boy	100.00 TL
----------------------	-----------



**Eko 6002 Seri
Döner Moblen Teker**

MHB 80 - 50 kg	110.66 TL
MHB 100 - 70 kg	127.74 TL
MHB 125 - 100 kg	176.86 TL
MHB 150 - 120 kg	198.70 TL



**Eko 6000 Seri
Delikli Pimsiz Moblen Teker**

MHB 80 - 50 kg	113.73 TL
MHB 100 - 70 kg	129.41 TL
MHB 125 - 100 kg	181.55 TL
MHB 150 - 120 kg	203.46 TL



**Eko 6003 Seri
Pimli Teker**

SLB 80 - 50 kg	205.46 TL
SLB 100 - 70 kg	224.47 TL
SLB 125 - 100 kg	307.87 TL
SLB 150 - 120 kg	350.58 TL



**Eko 6002 Seri
Döner Frenli Teker**

SLB 80 F4 - 50 kg	190.42 TL
SLB 100 F4- 70 kg	202.28 TL
SLB 125 F4- 100 kg	259.68 TL
SLB 150 F4- 120 kg	310.85 TL
SLB 200 F4- 160 kg	562.93 TL



**Eko 6004 Seri
Sabit Moblen Teker**

MHB 80 - 50 kg	69.35 TL
MHB 100 - 70 kg	90.11 TL
MHB 125 - 100 kg	134.83 TL
MHB 150 - 120 kg	162.23 TL



**Eko 6003 Seri
Pimli Moblen Frenli Teker**

MHB 80 F4 - 50 kg	196.06 TL
MHB 100 F4- 70 kg	216.42 TL
MHB 125 F4- 100 kg	318.21 TL
MHB 150 F4- 120 kg	346.45 TL



**Eko 6003 Seri
Pimli Frenli Teker**

SLB 80 F4 - 50 kg	239.64 TL
SLB 100 F4- 70 kg	257.64 TL
SLB 125 F4- 100 kg	354.58 TL
SLB 150 F4- 120 kg	404.01 TL



**3002 Seri Konteynır Tip
Sac Döner Teker**

SLB 100 - 100 kg	216.29 TL
SLB 120 - 120 kg	248.97 TL
SLB 150 - 150 kg	301.17 TL
SLB 200 - 200 kg	501.09 TL



**Eko 6002 Seri
Döner Moblen Frenli Teker**

MHB 80 F4- 50 kg	144.84 TL
MHB 100 F4- 70 kg	161.06 TL
MHB 125 F4- 125 kg	223.31 TL
MHB 150 F4- 150 kg	253.39 TL



**Eko 6000 Seri
Delikli Pimsiz Moblen
Frenli Teker**

MHB 80 F4 - 50 kg	146.61 TL
MHB 100 F4- 70 kg	164.44 TL
MHB 125 F4- 100 kg	226.06 TL
MHB 150 F4- 120 kg	257.92 TL



Eko 6002 Seri Döner Teker

SLB 80 - 50 kg	156.24 TL
SLB 100 - 70 kg	168.46 TL
SLB 125 - 100 kg	213.22 TL
SLB 150 - 120 kg	256.26 TL
SLB 200 - 160 kg	458.35 TL



**3004 Seri Konteynır Tip
Sac Sabit Teker**

SLB 100 - 100 kg	175.00 TL
SLB 125 - 120 kg	206.00 TL
SLB 150 - 150 kg	280.00 TL
SLB 200 - 200 kg	452.00 TL



**Moblen Polyamid Yedek
Teker (Hafif Seri)**

MHB 80x25 - 50 kg	11.65 TL
MHB 100x30-70 kg	20.09 TL
MHB 125x37.5-100 kg	44.72 TL
MHB 150x40-120 kg	50.71 TL



**Eko 6000 Seri Merkez
Delikli Pimsiz Teker**

SLB 80 - 50 kg	159.30 TL
SLB 100 - 70 kg	170.63 TL
SLB 125 - 100 kg	217.91 TL
SLB 150 - 120 kg	261.02 TL



Eko 6004 Seri Sabit Teker

SLB 80 - 50 kg	114.93 TL
SLB 100 - 70 kg	131.33 TL
SLB 125 - 100 kg	171.20 TL
SLB 150 - 120 kg	219.78 TL
SLB 200 - 160 kg	375.83 TL



**3002 Seri Konteynır Tip
Sac Dönerli Frenli Teker**

SLB 100 F4- 70 kg	268.96 TL
SLB 125 F4- 100 kg	295.71 TL
SLB 150 F4- 120 kg	355.75 TL
SLB 200 F4- 160 kg	598.98 TL



**Eko 6003 Seri
Pimli Moblen Teker**

MHB 80 - 50 kg	159.88 TL
MHB 100 - 70 kg	183.05 TL
MHB 125 - 100 kg	271.51 TL
MHB 150 - 120 kg	293.00 TL



**Eko 6000 Seri Merkez
Delikli Pimsiz Frenli Teker**

SLB 80 F4 - 50 kg	192.19 TL
SLB 100 F4- 70 kg	205.66 TL
SLB 125 F4- 100 kg	262.43 TL
SLB 150 F4- 120 kg	315.47 TL



SLB 20 Seri Yedek Teker

SLB 80x25 - 50 kg	57.23 TL
SLB 100x30-70 kg	61.31 TL
SLB 125x37.5-100 kg	81.08 TL
SLB 150x40-120 kg	108.27 TL
SLB 200x50-150 kg	239.00 TL



**4002 Seri
Ağır Taşıyıcı Döküm
Döner Teker**

ADB 55 - 100 kg	183.09 TL
ADB 80 - 140 kg	343.70 TL
ADB 100 - 200 kg	535.33 TL
ADB 125 - 350 kg	644.48 TL
ADB 150 - 400 kg	913.13 TL



**4004 Seri
Ağır Taşıyıcı Döküm
Sabit Teker**

ADB 55 - 140 kg	151.11 TL
ADB 80 - 200 kg	227.23 TL
ADB 100 - 350 kg	434.46 TL
ADB 125 - 450 kg	542.02 TL
ADB 150 - 600 kg	704.55 TL



**4002 Seri
Polyamid Ağır Tip Burçlu
Döner Teker**

MAB 55 - 100 kg	91.42 TL
MAB 80 - 150 kg	223.58 TL
MAB 100 - 200 kg	333.05 TL
MAB 125 - 280 kg	371.52 TL
MAB 150 - 350 kg	550.20 TL
MAB 200 - 500 kg	707.21 TL



**4004 Seri
Polyamid Ağır Tip Burçlu
Sabit Teker**

MAB 55 - 100 kg	59.44 TL
MAB 80 - 150 kg	107.11 TL
MAB 100 - 200 kg	232.18 TL
MAB 125 - 280 kg	269.06 TL
MAB 150 - 350 kg	341.62 TL
MAB 200 - 500 kg	483.58 TL



**4002 Seri
Polyamid Ağır Tip Burçlu
Frenli Teker**

MAB 55 F4 - 100 kg	111.70 TL
MAB 80 F3- 150 kg	341.07 TL
MAB 100 F3- 200 kg	430.86 TL
MAB 125 F3- 280 kg	469.33 TL
MAB 150 F3- 350 kg	669.83 TL



**4002 Seri
Ağır Taşıyıcı Döküm
Üzeri PU Kaplı Rulmanlı
Döner Teker**

DUR 80 - 200 kg	557.44 TL
DUR 100 - 350 kg	753.17 TL
DUR 125 - 450 kg	924.95 TL
DUR 150 - 600 kg	1216.17 TL
DUR 200 - 900 kg	1852.45 TL



**4002 Seri
Ağır Taşıyıcı Döküm
Üzeri PU Kaplı Rulmanlı
Frenli Teker**

DUR 80 F3- 200 kg	674.42 TL
DUR 100 F3- 350 kg	850.92 TL
DUR 125 F3- 450 kg	1022.76 TL
DUR 150 F3- 600 kg	1395.80 TL
DUR 200 F3- 900 kg	1970.96 TL



**4004 Seri
Ağır Taşıyıcı Döküm
Üzeri PU Kaplı Rulmanlı
Sabit Teker**

DUR 80 - 200 kg	440.97 TL
DUR 100 - 350 kg	652.29 TL
DUR 125 - 450 kg	822.49 TL
DUR 150 - 600 kg	1067.59 TL
DUR 200 - 900 kg	1628.82 TL



**PU Kaplı Döküm
Rulmanlı Yedek Teker**

DUR 80x30 - 200 kg	352.72 TL
DUR 100x35 - 350 kg	452.57 TL
DUR 125x40 - 450 kg	606.12 TL
DUR 150x45 - 600 kg	800.61 TL
DUR 200x50 - 900 kg	1316.96 TL



4002 Seri Ağır Taşıyıcı Döküm Frenli Teker

ADB 55 F4 - 140 kg	203.37 TL
ADB 80 F3- 200 kg	461.19 TL
ADB 100 F3- 350 kg	633.14 TL
ADB 125 F3- 450 kg	742.29 TL



**3002 Seri
Moblen Üzeri PU Kaplı
Frenli Burçlu Teker**

PUB 80 F4	187.76 TL
100 kg 100x35	
PUB 100 F4	264.27 TL
135 kg 124x40	
PUB 125 F4	308.32 TL
170 kg 150x45	
PUB 150 F4	405.43 TL
210 kg 200x50	



**3002 Seri
Moblen Üzeri PU Kaplı
Burçlu Döner Teker**

PUB 80	151.30 TL
100 kg 80x30	
PUB 100	211.59 TL
135 kg 100x35	
PUB 125	261.58 TL
170 kg 125x40	
PUB 150	350.85 TL
210 kg 150x45	
PUB 200	669.60 TL
300 kg 200x50	



**3004 Seri Taşıyıcı
Moblen Üzeri PU Kaplı
Sabit Burçlu Teker**

PUB 80	107.24 TL
100 kg 80x30	
PUB 100	169.61 TL
135 kg 100x35	
PUB 125	215.83 TL
170 kg 124x40	
PUB 150	302.50 TL
210 kg 150x45	
PUB 200	588.19 TL
300 kg 200x50	



**Moblen Üzeri PU Kaplı
Yedek Teker**

PUB 80x30 100 kg	47.70 TL
PUB 100x35 200 kg	77.21 TL
PUB 125x40 280 kg	119.10 TL
PUB 150x45 350 kg	190.87 TL
PUB 200x50 600 kg	407.51 TL



**4002 Seri Ağır Taşıyıcı
Moblen Üzeri PU Kaplı
Frenli Burçlu Teker**

PUB 100 F3	475.61 TL
200 kg 100x35	
PUB 125 F3	535.74 TL
280 kg 124x40	
PUB 150 F3	786.06 TL
350 kg 150x45	
PUB 200 F3	1061.51 TL
600 kg 200x50	



**4002 Seri Ağır Taşıyıcı
Moblen Üzeri PU Kaplı
Burçlu Döner Teker**

PUB 80	250.42 TL
100 kg 80x30	
PUB 100	377.81 TL
200 kg 100x35	
PUB 125	437.94 TL
280 kg 125x40	
PUB 150	666.44 TL
350 kg 150x45	
PUB 200	943.00 TL
600 kg 200x50	



**4004 Seri Ağır Taşıyıcı
Moblen Üzeri PU Kaplı
Sabit Burçlu Teker**

PUB 80	133.94 TL
100 kg 80x30	
PUB 100	276.93 TL
200 kg 100x35	
PUB 125	335.47 TL
280 kg 124x40	
PUB 150	457.85 TL
350 kg 150x45	
PUB 200	719.37 TL
600 kg 200x50	



**Moblen Üzeri PU Kaplı
Rulmanlı Yedek Teker**

PUR 100x35 200 kg	134.23 TL
PUR 125x40 280 kg	174.71 TL
PUR 150x45 350 kg	247.48 TL
PUR 200x50 600 kg	405.41 TL



1100 Seri
MHB 50, 30 kg 40.28 TL
MHB 075, 50 kg 70.17 TL



1100 Seri
MEB 50, 30 kg 43.50 TL
MEB 075, 50 kg 73.73 TL



1302 Seri
MEB 50, 50 kg 75.13 TL



1801 Seri
PPB 50, 21.00 TL
PPB 050 FR, 30.50 TL



1100 Frenli Seri
MHB 50 FR, 30 kg 61.01 TL
MHB 075 FR, 50 kg 92.97 TL



1100 Frenli Seri
MEB 50 FR, 30 kg 64.32 TL
MEB 075 FR, 50 kg 96.53 TL



1302 Frenli Seri
MEB 50 FR, 50 kg 111.94 TL



3002 Seri Ağır Taşıyıcı Döküm Üzeri PU Kaplı Rulmanlı Döner Teker
DUR 80 458.33 TL
100 kg
DUR 100 586.96 TL
135 kg
DUR 125 748.59 TL
170 kg
DUR 150 960.59 TL
240 kg
DUR 200 1579.06 TL
300 kg



1101 Seri
MHB 50, 30 kg 41.10 TL
MHB 075, 50 kg 62.22 TL



1101 Seri
MEB 50, 30 kg 44.41 TL
MEB 075, 50 kg 65.78 TL



1301 Seri
MEB 50, 50 kg 70.52 TL



1301 Frenli Seri
MEB 50 FR, 50 kg 106.00 TL



1101 Frenli Seri
MHB 50 FR, 30 kg 61.58 TL
MHB 075 FR, 50 kg 85.02 TL



1101 Frenli Seri
MEB 50 FR, 30 kg 64.89 TL
MEB 075 FR, 50 kg 88.58 TL



1802 Seri
PPB 40, 20 kg 17.50 TL
PPB 50, 30 kg 22.75 TL



3004 Seri Ağır Taşıyıcı Döküm Üzeri PU Kaplı Rulmanlı Sabit Teker
DUR 80 414.26 TL
100 kg
DUR 100 544.98 TL
135 kg
DUR 125 702.85 TL
170 kg
DUR 150 912.33 TL
240 kg
DUR 200 1497.64 TL
300 kg



1102 Seri
MHB 50, 30 kg 43.17 TL
MHB 075, 50 kg 67.02 TL



1102 Seri
MEB 50, 30 kg 46.48 TL
MEB 075, 50 kg 70.58 TL



1802 Frenli Seri
PPB 40 FR, 20 kg 20.15 TL
PPB 50 FR, 30 kg 30.50 TL



1102 Frenli Seri
MHB 50 FR, 30 kg 63.01 TL
MHB 075 FR, 50 kg 89.52 TL



1102 Frenli Seri
MEB 50 FR, 30 kg 66.32 TL
MEB 075 FR, 50 kg 93.08 TL



2001 Seri
MEB 100, 100 kg 157.86 TL
MEB 125, 125 kg 176.08 TL



1104 Seri
MHB 50, 30 kg 25.75 TL
MHB 075, 50 kg 52.74 TL



1104 Seri
MEB 50, 30 kg 29.06 TL
MEB 075, 50 kg 56.30 TL



2003 Seri
MEB 100, 100 kg 160.43 TL
MEB 125, 125 kg 178.65 TL

3002 Seri Ağır Taşıyıcı Döküm Üzeri PU Kaplı Rulmanlı Döner Frenli Teker
DUR 80 F3 556.13 TL
100 kg
DUR 100 F3 684.76 TL
135 kg
DUR 125 F3 846.40 TL
170 kg
DUR 150 F3 1058.39 TL
240 kg
DUR 200 F3 1685.17 TL
300 kg



Sac Jantlı Dolgu Rulmanlı Tekerler

255-20R - 250x50x20	310.00 TL
258-20R - 250x80x20	395.00 TL
370-20R - 300x70x20	403.00 TL
327-20R - 325x75x20	445.00 TL

Harç Arabası Tekerleği



Sac Jantlı Dolgu Burçlu Teker

358-25B- 350x80x25
El arabası tekeridir. 170.00 TL

Sac Jantlı Dolgu Rulmanlı Teker
327-25R- 325x75x25 210.00 TL

Sac Jantlı Havalı Teker
SHR02- 350x7x20 315.00 TL



MAB Yedek Teker 055x25

7.62 TL



Transpalet Tekerleri (Polyamid)

70x60 Rulmansız	61.90 TL
82x70 (6204) Rulmanlı	175.51 TL
82x70 Rulmansız	106.51 TL
160x50x20 (6204) Rulmanlı	247.73 TL
180x50x20 Rulmanlı	271.27 TL
200x50x20 Rulmanlı	300.30 TL



Transpalet Tekerleri (Döküm + PU)

70x60x20 Rulmanlı	389.19 TL
82x70 (6204) Rulmanlı	589.05 TL
150x50x17 (6204) Rulmanlı	800.61 TL
200x50x20 Rulmanlı	1316.96 TL



Sac Jantlı Havalı (Şişme) Rulmanlı Tekerler

SHR01 - 300x4x20	380.00 TL
SHR05 - 350x7x20, 4 pr	
SHR07 - 350x8x20	
SHR17 - 400x8x20, 6 pr	

Sac Jantlı Dolgu Burçlu Tekerler

245-20B - 250x45x20	202.00 TL
255-20B - 250x50x20	247.00 TL
258-20B - 250x80x20	342.00 TL
370-20B - 300x70x20	358.00 TL
327-20B - 325x75x20	412.00 TL

Harç Arabası Tekerleği



Plastik Jantlı Havalı (Şişme) Rulmanlı Tekerler

MHS01 - 200x50x20	235.00 TL
MHS02 - 300x4x20	350.00 TL

İç Lastikler

300x4 İç Lastik	110.00 TL
350x8 İç Lastik	130.00 TL

Dış Lastikler

350x7 Dış Lastik	120.00 TL
------------------	-----------



Sabit Maşalı Teker

14.00 TL



Mobilya Gömme Teker

32.- TL

-Zeminden yükseklik toplam 8 mm'dir.
-Plastik malzemeden üretilmiştir. 35 mm delik delinerek montaj yapılır.
-Kullanıldığı alanlar içerisinde gizli tekerlek görevi görür.
-Ürün genellikle ana gövde tekerleğini göstermek yerine ürünün çalışırlığını gösterir.
-Piyasada en çok kullanılan sektör ise ağırlıklı olarak mobilya tv stand, sehpa gibi alanlarda kullanılır.
-Gömme tekerlek yerine ufo tekerlek olarak da bilinir.
-Ürünlerin aksesuar kategorisinde plastik gömme teker aksesuar olarak bilinir.



Plastik Jantlı Dolgu Burçlu Tekerler

P124-16 - 125x40x20	70.00 TL
P154-16 - 150x45x16	85.00 TL
P154-20 - 150x45x20	85.00 TL
P240-20 - 200x40x20	140.00 TL
P205-20 - 200x50x20	150.00 TL
P255-22 - 250x50x22	219.00 TL
P360-22 - 300x60x22	295.00 TL

Plastik Jantlı Dolgu Teker

P205-20 - 200x50x20	100.00 TL
---------------------	-----------

Çöp Konteynir Tekerleri



Mediven Tekerleği

38.00 \$

BİNEK ARAÇLAR (PCMO) BENZİNLİ MOTOR YAĞLARI



Maxima 5/40 Benzinli Motor Yağı (4 Lt) 870.- TL
Maxima 10W - 40 Benzinli Motor Yağı (4 Lt) 680.- TL
12.5 cST viskozite (100°), 156 V.I, 225° alevlenme noktası -38° akma noktası



Maxima 15W-40 Benzinli Motor Yağı

Üstün kaliteli mineral baz yağlara yüksek performans katıkları eklenerek üretilen motor yağıdır. Yüksek devirli eski ve yeni tip motorlarda kullanılır. Özellikle binek ve dur-kalk tipi ticari binek araçlar için uygundur. Sıcak ve soğukta tortu oluşumunu ve birikintiyi önleyerek motorun temiz kalmasını sağlar. Soğukta ilk çalışmayı kolaylaştırır, sıcakta ise etkili yağlama sağlar

Maxima 15W - 50 (4 Lt) 765.- TL
Maxima 15W - 50 (3 Lt) 665.- TL
15.1 cST viskozite (100°), 126 V.I, 215° alevlenme noktası -33° akma noktası



Maxima 20W-50 Benzinli Motor Yağı

Yüksek kalite ürünü baz yağlara yüksek performans katıkları eklenerek üretilen benzinli motor yağıdır. Özellikle zor şartlar altında çalışan, dur-kalk tipi şehir içi trafikte seyreden araçlar için uygundur. Yüksek performanslı ve turboşarjlı motorları da içeren binek otomobiller ve hafif ticari vasıtaların benzinli motorlarında kullanılır. Şehir içi trafik ve otoyol gibi zor koşullarda her mevsim rahatlıkla kullanılır.

Maxima 20W - 50 (4 Lt) 648.- TL
Maxima 20W - 50 (3 Lt) 466.- TL
19.5 cST viskozite (100°), 137 V.I, 222° alevlenme noktası -27° akma noktası



Kızak Yağı D (16 Kg Teneke) 2765.- TL
68 - 8.7 cST viskozite (40°-100°), 228° alevlenme noktası -18° akma noktası

Kızak Yağı G (16 Kg Teneke) 3035.- TL
220 - 18.52 cST viskozite (40°-100°), 242° alevlenme noktası -9° akma noktası



Saf Su
1 Kg 20.00 TL
20 Kg 260.00 TL
30 Kg 350.00 TL

HİDROLİK SİSTEM YAĞLARI

Yüksek stabiliteye sahip parafinik esaslı baz yağlara, aşınma, oksidasyon ve pas önleyici katık paketi eklenmesi ile üretilen yağlardır. Bütün endüstriyel ve hareketli hidrolik sistemler için önerilir. Özel endüstriyel uygulamaları içinde iş makineleri, presler, hareketli yapı elemanları, plastik enjeksiyon ve çekme makineleri vidalı hava kompresörleri yer alır. Havadan ve sudan ayrılma özelliği çok iyidir. Ağır çalışma şartları altında hidrolik sistemlerde bulunan pompa ve motorların aşınmasını önler. Köpük önleyici katık içermesi nedeni ile kavitasyonu engeller. Çalışma sıcaklığının geniş bir aralıkta değiştiği ağır iş makinelerinde ise HYDRO TECH HVI serisi yağlar tavsiye edilir.



Hydro Oil HD 32 (15 Kg) 2205.- TL
32-5.49 cST viskozite (40°-100°), 101 V.I, 212° alevlenme noktası -27° akma noktası

Hydro Oil HD 46 (15 Kg) 2135.- TL
48-6.9 cST viskozite (40°-100°), 101 V.I, 230° alevlenme noktası -24° akma noktası

Hydro Oil HD 68 (15 Kg) 2164.- TL
68-8.40 cST viskozite (40°-100°), 101 V.I, 236° alevlenme noktası -24° akma noktası

METAL KESME VE İŞLEME YAĞLARI

Çeşitli metallerin kesme ve taşlama işlerinde maksimum soğutma ve yağlama sağlayan, su ile emülsiyon yaparak kullanılan parafinik esaslı kesme yağlarıdır. Alüminyum ve bakır alaşımları, yumuşak çelik ve dökme demir gibi metallerin hafif ve ağır talaş kaldırma işlemlerinde ve alüminyum çubukların sıcak çekilmesinde yağlayıcı ve soğutucu olarak kullanılır. Emülsiyon pH'ı 9.0'dır. Çok iyi pastan koruma ve kesme karakteristiğine sahiptir. Emülsiyon stabilitesi yüksektir.



Bor Yağı (15 Kg) 4 187.- TL
43 cST viskozite (40-100°)
Bor Yağı (Fıçılı, 170 Kg) 45 770.- TL



DİZEL MOTOR YAĞLARI

Süper yüksek performanslı dizel motor yağı (SHPD) kalite seviyesinde uzun ömürlü dizel motor yağıdır. Düşük ve yüksek küllütle içeren yakıtlarla çalışan dizel motorlarda mükemmel performans sağlar. Turboşarjlı ve düşük emisyonlu dizel motorlar başta olmak üzere dizel motora sahip tüm kamyon, otobüs, tır, iş makinesi ve jeneratör uygulamaları için önerilir.

Special 10W Motor Yağı (15 Kg) 2290.- TL
6.5 cST viskozite (100°), 105 V.I, 236° alevlenme noktası -30° akma noktası

Special 30 Motor Yağı (15 Kg) 2385.- TL
12.2 cST viskozite (100°), 95 V.I, 265° alevlenme noktası -18° akma noktası

Special 40 Motor Yağı (15 Kg) 9175.- TL
15.0 cST viskozite (100°), 96 V.I, 270° alevlenme noktası -15° akma noktası

OTOMOTİV GRESLER

Geniş sıcaklık aralığında kullanılan, suya, ısıya ve yüke dayanıklı çok amaçlı gresdir. Endüstrinin özel gres talep etmeyen birçok değişik uygulama sahasında tek çeşit gres olarak kullanılır. Düz ve rulmanlı yataklar, her çeşit kayma yüzeyleri, her türlü greslenecek noktalar için uygundur. Otomotiv tip ekipmanlarının gresleme yerlerinde de kullanılır. Çok aşırı veya şok yüklerine karşı uygulanmamalıdır. Rahat pompalanır. Aşırı basınç (EP) katkılı olup oksidasyona karşı dayanımı yüksektir. Mekanik stabilitesi ve suya karşı direnci yüksektir. Baz yağ viskozitesi ISO VG 100'dür. -15 ile 120° C aralığında çalışırlar.



Süper Gres 3 (1 Lt) 252.- TL
Süper Gres 3 (4 Kg) 980.- TL
Süper Gres 3 (15 Kg) 3 715.- TL



Kauçuklu Gres 3 (1 Kg) 165.- TL
Kauçuklu Gres 3 (4 Kg) 665.- TL
Kauçuklu Gres 3 (15 Kg) 2 175.- TL

Hafif ve ticari araçların her türlü rulman ve şasi uygulamaları ile tarım makineleri için geliştirilmiş, aşınma önleme özellikli yüksek kıvamlı greştir.

Sabun cinsi Kalsiyum, 244 (işlenmiş penetrasyon25⁰), 90° damlama noktası

ENDÜSTRİYEL GRESLER

Asın basınç (EP) katığı içeren, çok amaçlı greştir. Endüstride ağır ve şok yüklerin mevcut olduğu her yerde kullanılır. Islak ya da kuru şartlar altında aynı başarıyla uygulanır. Çok iyi aşın basınç karakteristiği gösterir. Oksidasyona, suya, mekanik kırılmalara dirençlidir. Yatak materyaline karşı korozif değildir. Timken testinden min 50 lb'da geçer. Baz yağ viskozitesi ISO VG 220'dir. -12 ile 130° C aralığında çalışırlar.



Suya dayanıklı bir greştir. Çalışma sıcaklığının 120° C'yi aşmadığı hallerde, özellikle normal yük altında düşük devirli düz yataklarda çabuk ve etkili yağlama sağlarlar. Uygulanması kolaydır. Kap Gres 3, su pompalarında sızdırmazlık sağlanması yönünden çok uygundur.

Kap Gres 3 (1 Kg) 198.- TL
Kap Gres 3 (4 Kg) 775.- TL
Kap Gres 3 (Teneke 14 Kg) 2 290.- TL
Kap Gres 3 (Fıçılı 208 Lt) 27 500.- TL

Sabun cinsi Kalsiyum, 244 (işlenmiş penetrasyon25⁰), 115° damlama noktası

Antifiriz

1 lt
3 lt
5 lt
15 lt



CRN Antifiriz

3 lt - Kırmızı - 37 C° 5.94 \$
3 lt - Mavi - 37 C° 5.94 \$
3 lt - Kırmızı - 56 C° 5.94 \$
3 lt - Mavi - 56 C° 5.94 \$



MANUAL ŞANZİMAN YAĞLARI

Yüksek kaliteli parafinik baz yağlar ve aşırı basınç (EP), aşınma, pas, korozyon, oksidasyon ve köpük önleyici katıkların kombinasyonu ile üretilen dişli yağlarıdır. Binek araçlar ile ağır vasıtaların vites kutuları, diferansiyelleri ile spiral, konik, hipoid dişliler ve turbo dizellerin dişli sistemlerinde dört mevsim kullanılır.

Üniversal Keban EP 80W/90 (16 kg) 2530.- TL
198-18.0 cSt viskozite (40°-100°), 98 V.I., 210° alevlenme noktası, -24° akma noktası

Üniversal Keban EP 85W/140 (16 kg) 3000.- TL
428-29.0 cSt viskozite (40°-100°), 95 V.I., 222° alevlenme noktası, -18° akma noktası



OTOMATİK ŞANZİMAN YAĞLARI

Parafinik esaslı baz yağlara pas ve aşınma önleyici, asın basınca dayanıklı özel katık paketi ilavesi ile üretilmektedir. Diferansiyel, düz şanzıman ve hipoid dişliler için orta şartlarda kullanılmak üzere geliştirilmiş asın basınç (EP) dişli yağlarıdır. Yüksek hız-düşük tork, düşük hız-yüksek tork şartlarında çalışan binek tip araçlarda, kamyonlarda, otobüslerde ve inşaat ekipmanlarında kullanılır.

Keban EP 80 (3 lt) 735.00 TL

87-10.5 cSt viskozite (40°-100°), 102 V.I., 190° alevlenme noktası, -30° akma noktası



Hidrolik Direksiyon Yağı ATF 2 (1 lt)

237.- TL

Çok iyi rafineri edilmiş parafinik esaslı baz yağlarda oksidasyon, pas ve korozyona dayanıklılık sağlayıcı, köpük önleyici katık paketi kombinasyonu ile üretilen otomatik şanzıman yağıdır, binek arabalarda, ağır vasıtaların direksiyon dişlilerinde, otomatik şanzıman ve transmisyonlarda kullanılır.

HİDROLİK FREN YAĞLARI

Sentetik esaslı olup her türlü aracın hidrolik tertibatında basın ile kullanılmaktadır. Donma noktası çok düşüktür, ilk kaynama noktası

DOT-3 için 205° C, DOT-4 için 260° C'dir.

Hidrolik Fren Yağı DOT-4 (500 cc) 139.- TL
Hidrolik Fren Yağı DOT-3 (500 cc) 118.- TL



Mobil Süper 2000x1
10W-40
1 Kg

455.00 TL



Hidrolik Sistem Yağları
Hidrolol 10 - 15 Kg 1655.00 TL
Hidrolol 46 - 15 Kg 1655.00 TL
Hidrolol 68 - 15 Kg 1735.00 TL



Kızak Yağı
15 Kg 1990.- TL



Bor Yağı
15 Kg 2195.- TL

HTD Kılavuz ve Çekme Yağı
0.5 Kg 13.90 €



Ticari Araç - Dizel Motor Yağları

Moliba SAE 10 Genel Yağlama Yağı
15 Kg 1815.- TL

Moliba SAE 30 Genel Yağlama Yağı
14 Kg 1815.- TL



Moliga Beyaz Gres No:2
0.9 Kg 240.00 TL
4 Kg 1000.00 TL
15 Kg 3575.00 TL

Moliga Kırmızı Gres No:3
0.9 Kg 128.00 TL
4 Kg 515.00 TL
15 Kg 1725.00 TL

Moliga Kauçuklu Gres No:3
0.9 Kg 127.00 TL
4 Kg 515.00 TL
15 Kg 1770.00 TL



DOT3 Hidrolik Fren Sıvısı
0.5 Lt 109.- TL

DOT4 Hidrolik Fren Sıvısı
0.5 Lt 128.- TL



BOA Turbo Dizel Motor Yağı
15W - 40, 4 Lt 465.- TL
15W - 40, 3 Lt 351.- TL



BOA Turbo Dizel Motor Yağı
20W - 50, 1 Lt 135.- TL
20W - 50, 4 Lt 455.- TL



GRADO Benzinli Motor Yağı
20W - 50, 1 Lt 146.00 TL
20W - 50, 3 Lt 370.00 TL
20W - 50, 4 Lt 470.00 TL

GRADO LPG Motor Yağı
20W - 50, 1 Lt 145.- TL
20W - 50, 3 Lt 365.- TL



GRADO FM Benzinli Motor Yağı
5W - 30, 4 Lt 725.- TL

GRADO Premium Dizel Motor Yağı (Partiküllü)
5W - 30, 4 Lt 760.- TL

GRADO Nitro LPG Motor Yağı
10W - 40, 1 Lt 182.- TL



Direksiyon Kutusu Yağı
1 Lt 135.- TL

ATF Dexron Otomatik Şanzıman Yağı
1 Lt 165.- TL



EOLO Super 2T
1 Lt 148.- TL



EOLO Super 4T
10W - 40, 1 Lt 172.00 TL
20W - 40, 1 Lt 158.00 TL



Motorlu Ağaç Testere Yağı
1 Lt 167.- TL



Transmol Şanzıman ve Direransiyel Yağları

TRANSMOL SAE 80W - 90, 3 Lt 465.- TL
80W - 90, 15 Kg 1975.- TL

TRANSMOL SAE 90 EP - 3 Lt 385.- TL
90 EP - 15 Kg 1875.- TL
140 EP - 15 Kg 2150.- TL



Ağır Tip Kelepçeler

17x19 mm	41.51 TL
19x21 mm	43.18 TL
21x23 mm	43.18 TL
25x27 mm	46.49 TL
27x29 mm	46.49 TL
29x31 mm	48.16 TL
31x34 mm	48.16 TL
34x37 mm	49.82 TL
37x40 mm	49.82 TL
40x43 mm	51.48 TL
43x47 mm	53.14 TL
47x51 mm	53.14 TL
51x55 mm	53.95 TL
55x59 mm	54.80 TL
59x63 mm	55.62 TL
63x68 mm	56.64 TL
68x73 mm	65.40 TL
73x79 mm	67.23 TL
79x85 mm	67.23 TL
85x91 mm	69.12 TL
91x97 mm	70.98 TL
97x104 mm	70.98 TL
104x112 mm	72.85 TL
112x121 mm	72.85 TL
121x130 mm	74.71 TL
130x140 mm	93.15 TL
140x150 mm	94.38 TL
150x162 mm	96.62 TL
162x174 mm	99.05 TL
174x187 mm	101.83 TL
187x200 mm	104.65 TL
200x213 mm	107.69 TL
213x226 mm	110.97 TL
226x239 mm	112.98 TL
239x252 mm	114.08 TL

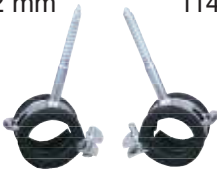

Somunlu Kelepçeler (Trifonsuz)

1/2	300 Adet	12.65 TL
3/4	250 Adet	13.45 TL
1	200 Adet	14.55 TL
1 1/4	150 Adet	17.50 TL
1 1/2	125 Adet	18.97 TL
2	80 Adet	21.55 TL
2 1/2	60 Adet	36.65 TL
3		41.50 TL
4		46.75 TL
6		76.00 TL

Trifonlu Doğalgaz Boru Kelepçesi

1/2	200 Adet	14.30 TL
3/4	200 Adet	15.00 TL
1	150 Adet	16.40 TL
1 1/4	120 Adet	19.25 TL
1 1/2	100 Adet	20.90 TL
2	80 Adet	23.10 TL
2 1/2	60 Adet	37.10 TL
3		40.70 TL
4		47.30 TL



Saç Hortum Kelepçeler

8x12 mm		5.54 TL
10x16 mm	21010	5.72 TL
13x19 mm	21020	6.06 TL
16x25 mm	21030	6.58 TL
19x26 mm	21040	11.56 TL
20x30 mm		14.99 TL
20x32 mm	21060	11.85 TL
23x35 mm	21070	12.08 TL
25x40 mm	21080	12.40 TL
25x42 mm		16.65 TL
28x48 mm	21090	13.21 TL
32x50 mm	21100	14.06 TL
38x58 mm	21110	18.81 TL
40x60 mm		14.65 TL
44x64 mm	21120	15.48 TL
50x70 mm	21130	17.99 TL
57x76 mm	21140	23.15 TL
60x80 mm	21150	19.98 TL
70x90 mm	21160	20.85 TL
80x100 mm	21170	22.55 TL
90x110 mm	21180	23.35 TL
100x120 mm	21190	26.44 TL
115x135 mm	21200	29.88 TL
130x150 mm	21220	30.95 TL
146x164 mm	21230	34.10 TL



Tel Hortum Kelepçeler

16x19 mm	42199	40.75 TL
19x23 mm	22000	40.75 TL
23x26 mm	22010	40.75 TL
26x32 mm	22020	40.75 TL
30x38 mm	22030	41.50 TL
38x42 mm	22040	44.70 TL
42x48 mm	22050	46.75 TL
48x52 mm	22060	49.10 TL
52x58 mm	22070	51.47 TL
58x62 mm	22080	53.15 TL
62x65 mm	22207	53.70 TL
65x72 mm	22090	54.40 TL
72x76 mm	22091	55.35 TL
76x82 mm	22093	57.10 TL
82x86 mm	22094	58.40 TL
92x96 mm	22095	59.55 TL
96x103 mm	22096	59.90 TL
103x115 mm	22092	60.60 TL
115x125 mm	22097	60.75 TL
125x140 mm	22098	63.25 TL
140x152 mm	22210	65.45 TL
152x165 mm	22220	67.00 TL
165x176 mm	22230	69.10 TL
185x200 mm	22240	74.00 TL
200x215 mm	22250	81.00 TL
215x235 mm	22260	85.00 TL



Çelik Döbel Çekme (Borulu)

Asansör, ray ve çit montajlarında tercih edilir. Kovanı borudan ima edilmiş döbel. Beton kalitesi düşük yüklerde kullanılır.

M6 x 65 mm	9.1800 TL
M8 x 75 mm	10.4000 TL
M10 x 85 mm	15.2500 TL
M12 x 90 mm	20.7500 TL
M12 x 110 mm	21.5000 TL
M14 x 110 mm	40.0000 TL
M16 x 120 mm	52.0000 TL

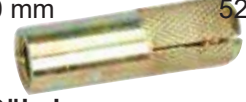

Çakmalı Döbel

Gijon ile test imkanı sağlayan karot makinesi ile iskele montajlarında kullanılabışlen galvaniz kaplı döbel.

M6 - 20mm	2.6800 TL
M8 - 30 mm	3.3000 TL
M10 - 40 mm	5.7000 TL
M12 - 50mm	12.3000 TL
M14 - 55 mm	23.0000 TL
M16 - 65 mm	28.7500 TL
M20 - 80 mm	88.0000 TL



Saç Gömleklili Döbel

Beton kalitesinin yüksek olmadığı alanlarda kullanılan galvaniz kaplı çelik döbel.

M6 x 8 x 65	3.8000 TL
M8 x 10 x 55	4.6000 TL
M8 x 10 x 75	5.9500 TL
M10 x 12 x 70	8.6000 TL
M10 x 12 x 85	9.3000 TL
M10 x 12 x 110	11.5000 TL
M12 x 16 x 90	16.6000 TL
M12 x 16 x 110	19.3000 TL



Kancalı Döbel

Gömleklili döbel ile aynı özelliklerde asma amaçlı ağır yük döbelidir.

M6 x 45	8.800 TL
M8 x 60	12.500 TL
M10 x 90	21.100 TL



Kapalı Kancalı Döbel

U-bolt döbel, gömleklili döbel ile aynı özelliklerde asma amaçlı kapalı kancalı ağır yük döbelidir.

M6 x 45	9.000 TL
M8 x 60	12.750 TL
M8 x 100	18.700 TL
M10 x 90	21.750 TL



Klipsli Döbel

Asma yüklerinde, bağlantı kanallarında köşebent montajlarında, hız ve kolay kullanım imkanı sağlayan galvaniz kaplı çelik döbel.

M8 x 75	8.0000 TL
M10 x 90	11.0000 TL
M12 x 110	16.5000 TL
M16 x 145	36.5000 TL
M20 x 180	104.0000 TL



S Tipi Döbel

M8	3.8000 TL
M10	6.2000 TL
M12	11.7000 TL



Metal Kelepçeler

8 -13x8 mm	MK1820	0.068 \$
10 -16x8 mm	MK1821	0.068 \$
13 -19x8 mm	MK1822	0.068 \$
16 -23x8 mm	MK1823	0.078 \$
18 -25x8 mm	MK1824	0.078 \$
19 -26x13 mm	MK1830	0.190 \$
20 -30x13 mm	MK1831	0.190 \$
22 -36x13 mm	MK1832	0.190 \$
25 -42x13 mm	MK1833	0.210 \$
28 -48x13 mm	MK1834	0.210 \$
38 -58x13 mm	MK1835	0.220 \$
44 -64x13 mm	MK1836	0.230 \$
51 -72x13 mm	MK1837	0.250 \$
57 -76x13 mm	MK1838	0.270 \$
65 -82x13 mm	MK1839	0.280 \$
76 -92x13 mm	MK1840	0.310 \$
85 -103x13 mm	MK1841	0.320 \$
92 -110x13 mm	MK1842	0.340 \$
105 -121x13 mm	MK1843	0.380 \$
115 -135x13 mm	MK1844	0.420 \$
130 -146x13 mm	MK1845	0.450 \$
146 -164x13 mm	MK1846	0.490 \$



Kabo Bağı - BEYAZ (100 Adetlik torba fiyatı)

2.5 x 100 mm	MK1782	0.42 \$
2.5 x 150 mm	MK1783	0.60 \$
2.5 x 200 mm	MK1784	0.90 \$
2.5 x 250 mm	MK1785	1.00 \$
3.6 x 150 mm	MK1786	0.88 \$
3.6 x 200 mm	MK1787	1.20 \$
3.6 x 250 mm	MK1788	1.44 \$
3.6 x 300 mm	MK1789	1.78 \$
3.6 x 370 mm	MK1791	2.40 \$
4.8 x 200 mm	MK1792	1.83 \$
4.8 x 250 mm	MK1793	2.56 \$
4.8 x 300 mm	MK1794	2.70 \$
4.8 x 380 mm	MK1795	3.40 \$
4.8 x 450 mm	MK1796	4.33 \$
4.8 x 500 mm	MK1797	4.70 \$
8.0 x 300 mm	MK1797-2	5.30 \$
8.0 x 380 mm	MK1797-4	6.40 \$
8.0 x 450 mm	MK1797-6	7.46 \$
8.0 x 550 mm	MK1797-8	9.78 \$
8.0 x 650 mm	MK1797-10	12.94 \$
8.0 x 750 mm	MK1797-12	15.50 \$

Kabo Bağı - BEYAZ (100 Adetlik torba fiyatı)

3.6 x 150 mm	MES 4530	1.12 \$
3.6 x 200 mm	MES 4531	1.47 \$
3.6 x 250 mm	MES 4532	1.80 \$
3x6 x 300 mm	MES 4533	2.20 \$
3.6 x 370 mm	MES 4534	2.80 \$
4.8 x 200 mm	MES 1885	2.15 \$
4.8 x 250 mm	MES 1886	2.80 \$
3.6 x 300 mm	MES 1887	3.35 \$
4.8 x 380 mm	MES 4535	4.20 \$
4.8 x 450 mm	MES 1888	4.95 \$

KPG Pnömatik Redüksiyon Tipi Nipel

KPG 6 - 4 mm	0.39 \$
KPG 8 - 6 mm	0.45 \$
KPG 10 - 6 mm	0.58 \$
KPG 12 - 8 mm	0.77 \$
LPG 12 - 10 mm	0.77 \$



KPB Pnömatik Orta Bacak TE

1/8-6 mm KPB 6-G 01	0.84 \$
1/4-6 mm KPB 6-G 02	1.00 \$
1/8-8 mm KPB 8-G 01	1.00 \$
1/4-8 mm KPB 8-G 02	1.00 \$



KPY Pnömatik YE Bağlantı

KPY 6 mm	0.53 \$
KPY 8 mm	0.61 \$

Pnömatik Dirsek

KPV04 - 4 mm	0.33 \$
KPV06 - 6 mm	0.36 \$
KPV08 - 8 mm	0.38 \$
KPV10 - 10 mm	0.53 \$
KPV12 - 12 mm	0.69 \$



Kabo Bağı - SİYAH (100 Adetlik torba fiyatı)

2.5 x 100 mm	MK1798	0.42 \$
2.5 x 150 mm	MK1799	0.60 \$
2.5 x 200 mm	MK1800	0.90 \$
2.5 x 250 mm	MK1801	1.00 \$
3.6 x 150 mm	MK1802	0.88 \$
3.6 x 200 mm	MK1803	1.20 \$
3.6 x 250 mm	MK1804	1.44 \$
3.6 x 300 mm	MK1805	1.78 \$
3.6 x 370 mm	MK1806	2.40 \$
4.8 x 200 mm	MK1807	1.83 \$
4.8 x 250 mm	MK1808	2.56 \$
4.8 x 300 mm	MK1809	2.70 \$
4.8 x 380 mm	MK1810	3.40 \$
4.8 x 450 mm	MK1811	4.33 \$
4.8 x 500 mm	MK1812	4.70 \$
4.8 x 300 mm	MK1813-2	5.30 \$
4.8 x 380 mm	MK1813-4	6.40 \$
4.8 x 450 mm	MK1813-6	7.46 \$
4.8 x 550 mm	MK1813-8	9.78 \$
4.8 x 650 mm	MK1813-10	12.94 \$
4.8 x 750 mm	MK1813-12	15.50 \$

Kabo Bağı - SİYAH (100 Adetlik torba fiyatı)

3.6 x 150 mm	MES 1840	1.12 \$
3.6 x 200 mm	MES 1841	1.47 \$
3.6 x 250 mm	MES 1842	1.80 \$
3.6 x 300 mm	MES 1843	2.20 \$
3.6 x 370 mm	MES 1844	2.80 \$
4.8 x 200 mm	MES 1846	2.15 \$
4.8 x 250 mm	MES 1847	2.80 \$
3.6 x 300 mm	MES 1848	3.35 \$
4.8 x 380 mm	MES 1845	4.20 \$
4.8 x 450 mm	MES 1849	4.95 \$



KPC Pnömatik Düz Rakor

1/8-4 mm KPC 4- G 01	0.45 \$
1/4-4 mm KPC 4- G 02	0.49 \$
1/8-6 mm KPC 6- G 01	0.46 \$
1/4-6 mm KPC 6- G 02	0.47 \$
3/8-6 mm KPC 6- G 03	0.86 \$
1/2-6 mm KPC 6- G 04	1.28 \$
1/8-8 mm KPC 8- G 01	0.47 \$
1/4-8 mm KPC 8- G 02	0.47 \$
3/8-8 mm KPC 8- G 03	0.86 \$
1/2-8 mm KPC 8- G 04	1.28 \$
1/8-10 mm KPC 10- G 01	0.79 \$
1/4-10 mm KPC 10- G 02	0.85 \$
3/8-10 mm KPC 10- G 03	0.91 \$
1/2-10 mm KPC 10- G 04	1.30 \$
1/8-12 mm KPC 12- G 01	1.05 \$
1/4-12 mm KPC 12- G 02	1.16 \$
3/8-12 mm KPC 12- G 03	1.23 \$
1/2-12 mm KPC 12- G 04	1.37 \$



KPU Pnömatik Nipel

KPU 4 mm	0.31 \$
KPU 6 mm	0.34 \$
KPU 8 mm	0.36 \$
KPU 10 mm	0.54 \$
KPU 12 mm	0.65 \$



KPL Pnömatik Döner Dirsek

1/8-4 mm KPL 4-G 01	0.56 \$
1/4-4 mm KPL 4-G 02	0.69 \$
1/8-6 mm KPL 6-G 01	0.59 \$
1/4-6 mm KPL 6-G 02	0.66 \$
3/8-6 mm KPL 6-G 03	0.95 \$
1/8-8 mm KPL 8-G 01	0.59 \$
1/4-8 mm KPL 8-G 02	0.66 \$
3/8-8 mm KPL 8-G 03	1.00 \$
1/8-10 mm KPL 10-G 01	0.92 \$
1/4-10 mm KPL 10-G 02	0.97 \$
3/8-10 mm KPL 10-G 03	1.14 \$
1/8-12 mm KPL 12-G 01	1.22 \$
1/4-12 mm KPL 12-G 02	1.11 \$
3/8-12 mm KPL 12-G 03	1.23 \$



Pnömatik TE Bağlantı

KPE 4 mm	0.49 \$
KPE 6 mm	0.52 \$
KPE 8 mm	0.56 \$
KPE 10 mm	0.81 \$
KPE 12 mm	0.94 \$



KPA Hat Tipi Hız Ayar Vanası

KPA04 - 4 mm	2.03 \$
KPA06 - 6 mm	2.39 \$
KPA08 - 8 mm	2.69 \$
KPA010 - 10 mm	3.79 \$
KPA012 - 12 mm	5.92 \$



EPC Pnömatik Düz Rakor

1/8-4 mm EPC 4-G 01	0.55 \$
1/4-4 mm EPC 4-G 02	0.69 \$
1/2-4 mm EPC 4-G 04	1.83 \$
1/8-6 mm EPC 6-G 01	0.59 \$
1/4-6 mm EPC 6-G 02	0.77 \$
3/8-6 mm EPC 6-G 03	0.99 \$
1/2-6 mm EPC 6-G 04	1.64 \$
1/8-8 mm EPC 8-G 01	0.72 \$
1/4-8 mm EPC 8-G 02	0.76 \$
3/8-8 mm EPC 8-G 03	1.00 \$
1/2-8 mm EPC 8-G 04	1.87 \$
1/8-10 mm EPC 10-G 01	1.04 \$
1/4-10 mm EPC 10-G 02	1.13 \$
3/8-10 mm EPC 10-G 03	1.14 \$
1/2-10 mm EPC 10-G 04	1.92 \$
1/4-12 mm EPC 12-G 02	1.58 \$
3/8-12 mm EPC 12-G 03	1.67 \$
1/2-12 mm EPC 12-G 04	1.94 \$



EPL Pnömatik Döner Dirsek

1/8-4 mm EPL 4-G 01	0.69 \$
1/4-4 mm EPL 4-G 02	0.92 \$
1/8-6 mm EPL 6-G 01	0.86 \$
1/4-6 mm EPL 6-G 02	1.09 \$
3/8-6 mm EPL 6-G 03	1.32 \$
1/8-8 mm EPL 8-G 01	0.99 \$
1/4-8 mm EPL 8-G 02	1.13 \$
3/8-8 mm EPL 8-G 03	1.39 \$
1/8-10 mm EPL 10-G 01	1.99 \$
1/4-10 mm EPL 10-G 02	1.68 \$
3/8-10 mm EPL 10-G 03	1.99 \$
1/4-12 mm EPL 12-G 02	2.29 \$
3/8-12 mm EPL 12-G 03	2.57 \$



ESL Pnömatik Hız Ayar Dirsek

1/8-4 mm ESL 4-G 01	2.73 \$
1/4-4 mm ESL 4-G 02	2.89 \$
1/8-6 mm ESL 6-G 01	2.32 \$
1/4-6 mm ESL 6-G 02	2.82 \$
3/8-6 mm ESL 6-G 03	5.09 \$
1/8-8 mm ESL 8-G 01	2.43 \$
1/4-8 mm ESL 8-G 02	2.89 \$
3/8-8 mm ESL 8-G 03	4.82 \$
1/8-10 mm ESL 10-G 01	2.66 \$
1/4-10 mm ESL 10-G 02	2.84 \$
3/8-10 mm ESL 10-G 03	4.96 \$
1/4-12 mm ESL 12-G 02	3.39 \$
3/8-12 mm ESL 12-G 03	4.95 \$



EPD Pnömatik Yan Bacak TE

1/8-4 mm EPD 4-G 01	1.06 \$
1/4-4 mm EPD 4-G 02	1.06 \$
1/8-6 mm EPD 6-G 01	1.05 \$
1/4-6 mm EPD 6-G 02	1.40 \$
1/8-8 mm EPD 8-G 01	1.57 \$
1/4-8 mm EPD 8-G 02	1.57 \$
1/8-10 mm EPD 10-G 01	1.60 \$
1/4-10 mm EPD 10-G 02	1.67 \$
1/4-12 mm EPD 12-G 02	2.27 \$
3/8-12 mm EPD 12-G 03	2.40 \$



EPB Pnömatik Orta Bacak TE

1/8-4 mm EPB 4-G 01	1.26 \$
1/4-4 mm EPB 4-G 02	1.68 \$
1/8-6 mm EPB 6-G 01	1.04 \$
1/4-6 mm EPB 6-G 02	1.33 \$
1/8-8 mm EPB 8-G 01	1.14 \$
1/4-8 mm EPB 8-G 02	1.41 \$
1/8-10 mm EPB 10-G 01	1.58 \$
1/4-10 mm EPB 10-G 02	1.90 \$



EPY Pnömatik YE Bağlantı

EPY 4 mm	0.51 \$
EPY 6 mm	0.60 \$
EPY 8 mm	0.60 \$
EPY 10 mm	0.95 \$
EPY 12 mm	1.15 \$



EPE Pnömatik TE Bağlantı

EPE 4 mm	0.48 \$
EPE 6 mm	0.60 \$
EPE 8 mm	0.58 \$
EPE 10 mm	0.85 \$
EPE 12 mm	1.04 \$



EPU Pnömatik Nipel

EPU 4 mm	0.35 \$
EPU 6 mm	0.41 \$
EPU 8 mm	0.46 \$
EPU 10 mm	0.60 \$
EPU 12 mm	0.81 \$



EPZA Pnömatik Kruva

EPZA 4 mm	0.81 \$
EPZA 6 mm	0.87 \$
EPZA 8 mm	0.94 \$
EPZA 10 mm	1.26 \$
EPZA 12 mm	1.58 \$



Perde Geçiş Nipel

4 mm	1.14 \$
6 mm	1.48 \$
8 mm	1.74 \$
10 mm	2.87 \$
12 mm	3.40 \$



Pnömatik Redüksiyon Tipi Nipel

6 - 4 mm	0.46 \$
8 - 4 mm	0.59 \$
8 - 6 mm	0.52 \$
10 - 6 mm	0.64 \$
10 - 8 mm	0.64 \$
12 - 8 mm	0.91 \$
12 - 10 mm	0.82 \$
16 - 12 mm	2.44 \$



Otomatik Rakor Bağlantı

SF 20 - 1/4	87.00 TL
SF 20 - 1/2	87.00 TL



Otomatik Rakor Bağlantı

SF 20 - 1/4 Bilyalı	4.90 €
SF 20 - 1/2 Bilyalı	4.90 €



Otomatik Rakor Bağlantı

SM 20 - 1/4	87.00 TL
SM 20 - 1/2	87.00 TL



Otomatik Rakor Bağlantı

SM 20 - 1/4 Bilyalı	4.90 €
SM 20 - 1/2 Bilyalı	4.90 €



Otomatik Rakor Bağlantı

SH 20 - 6 mm	94.00 TL
SH 20 - 8 mm	94.00 TL
SH 20 - 10 mm	94.00 TL



Otomatik Rakor Bağlantı

SH 20 - 6 mm Bilyalı	4.90 €
SH 20 - 8 mm Bilyalı	4.90 €
SH 20 - 10 mm Bilyalı	4.90 €



Otomatik Rakor Bağlantı

PM 20 - 1/2	20.00 TL
PM 20 - 1/4	20.00 TL



Otomatik Rakor Bağlantı

PF 20 - 1/2	20.00 TL
PF 20 - 1/4	20.00 TL



Otomatik Rakor Bağlantı

PH 20 - 6 mm	19.00 TL
PH 20 - 8 mm	19.00 TL
PH 20 - 10 mm	19.00 TL



Hat Tipi Hız Ayar Vanası

4 mm	2.18 \$
6 mm	2.92 \$
8 mm	3.46 \$
10 mm	4.28 \$
12 mm	6.42 \$



PU Poliüretan Hava Hortumu
2 x 4 mm 0.20 €
(200 mt/top)

4 x 6 mm 0.31 €
(200 mt/top)

5.5 x 8 mm 0.47 €
(200 mt/top)

6.5 x 10 mm 0.77 €
(100 mt/top)

8 x 12 mm 1.05 €
(100 mt/top)



Spiral Hortum

5-8 mm x 7.5 mt MK1306 3.85 \$
5-8 mm x 15 mt MK1306-1 6.18 \$

Spiral Hortum Süper

5-8 mm x 7.5 mt MK1307 6.95 \$
5-8 mm x 15 mt MK1307-1 12.50 \$
8-12 mm x 7.5 mt MK1307-2 13.00 \$
8-12 mm x 15 mt MK1307-3 22.60 \$



BSP Hat Tipi Hidrolik Çekvalf
1/4" 6.90 €
3/8" 6.90 €
1/2" 7.15 €



1/2" Hidrolik Erkek Adaptör (Toz Kapaklı) 8.25 €



1/2" BSP Çabuk Bağlantı Adaptör Takımı 11.- €



3/8" 3 Yollu Döküm Küresel Vana 320 Bar HRN-BV3CCG38N 30.- €



1/2" 3 Yollu Döküm Küresel Vana 320 Bar HRN-BV3CCG12N 30.- €



63 mm Manometre G 1/4 Alttan Bağlantı

Ø63 mm - 0-2.5 Bar	83410	7.95 €
Ø63 mm - 0-4 Bar	83411	7.95 €
Ø63 mm - 0-6 Bar	83412	7.95 €
Ø63 mm - 0-16 Bar	83414	7.95 €
Ø63 mm - 0-25 Bar	83415	7.95 €
Ø63 mm - 0-40 Bar	83416	7.95 €
Ø63 mm - 0-60 Bar	83417	7.95 €
Ø63 mm - 0-100 Bar	83418	8.40 €
Ø63 mm - 0-315 Bar	83420	8.40 €
Ø63 mm - 0-600 Bar	83422	8.40 €

100 mm Manometre G 1/4 Alttan Bağlantı

Ø100 mm - 0-4 Bar	83430	13.65 €
Ø100 mm - 0-6 Bar	83432	13.65 €
Ø100 mm - 0-16 Bar	83434	13.65 €
Ø100 mm - 0-25 Bar	83435	13.65 €
Ø100 mm - 0-60 Bar	83437	13.65 €
Ø100 mm - 0-100 Bar	83438	14.80 €
Ø100 mm - 0-400 Bar	83440	14.80 €

63 mm Gliserinli Manometre G 1/4 Alttan Bağlantı

Ø63 mm - 0-4 Bar	83451	13.15 €
Ø63 mm - 0-16 Bar	83453	13.15 €
Ø63 mm - 0-60 Bar	83455	13.15 €
Ø63 mm - 0-100 Bar	83457	13.65 €
Ø63 mm - 0-315 Bar	83459	13.65 €

63 mm Gliserinli Manometre G 1/4 Arkadan Bağlantı

Ø63 mm - 0-1 Bar	83461	16.35 €
Ø63 mm - 0-40 Bar	83464	16.35 €
Ø63 mm - 0-100 Bar	83466	16.80 €
Ø63 mm - 0-315 Bar	83467	16.80 €
Ø63 mm - 0-600 Bar	83468	16.80 €

100 mm Gliserinli Manometre G 1/4 Arkadan Bağlantı

Ø100 mm - 0-2.5 Bar	83471	39.30 €
Ø100 mm - 0-4 Bar	83472	39.30 €
Ø100 mm - 0-6 Bar	83473	39.30 €
Ø100 mm - 0-16 Bar	83475	39.30 €
Ø100 mm - 0-250 Bar	83477	40.25 €
Ø100 mm - 0-315 Bar	83479	40.25 €



Vakummetre G 1/4 Alttan Bağlantı
Ø63 mm - 0-760 mm Hg 83710 7.95 €

Vakummetre G 1/2 Alttan Bağlantı
Ø100 mm - 0-760 mm Hg 83720 13.65 €

Hidrometre G 1/2 Alttan Bağlantı
Ø100 mm 84130 13.65 €
0-16 mm WS



AC 2000 16.50 \$
1/4 Filtre + Regülatör + Yağlayıcı



AC 4000 31.00 \$
1/2 Filtre + Regülatör + Yağlayıcı



AW 2000 10.75 \$
1/4 Filtre + Regülatör

AR 2000 8.00 \$
Regülatör 1/4 35253

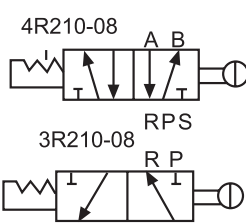

AR 210-08 Buton Valf 35251 12.50 \$
3R 210-08 Buton Valf 35241 12.50 \$

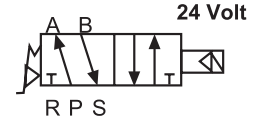

4V 210-08 Solenoid Valf 12.90 \$
Standart 24 volt bobin, isteğe bağlı olarak 220-240 volt bobin

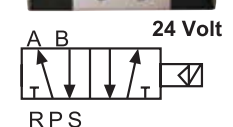

4V 220-08 Solenoid Valf 21.00 \$
Standart 24 volt bobin, isteğe bağlı olarak 220-240 volt bobin



FV 42 Pedal Valf 16.50 \$
4FV 210-08G 36.00 \$
Muhafazalı Pedal Valf



606 ZZ-C3 Rulman	0.54 \$
607 ZZ-C3 Rulman	0.54 \$
608 ZZ-C3 Rulman	0.52 \$
608 ZZ-C3 Karbon Rulman	0.36 \$
609 ZZ-C3 Rulman	0.58 \$
626 ZZ-C3 Rulman	0.58 \$
627 ZZ-C3 Rulman	0.58 \$
629 ZZ-C3 Rulman	0.58 \$
694 ZZ-C3 Rulman	0.58 \$

Düşük Devir Rulmanlar

608 ZZ-C1 Rulman	0.47 \$
629 ZZ-C1 Rulman	1.05 \$
6204 ZZ-C1 Rulman	



6000 ZZ-C3 Rulman	0.80 \$
6001 ZZ-C3 Rulman	0.90 \$
6002 ZZ-C3 Rulman	0.90 \$
6003 ZZ-C3 Rulman	1.20 \$
6004 ZZ-C3 Rulman	1.70 \$
6008 ZZ-C3 Rulman	4.90 \$
6016 ZZ-C3 Rulman	21.00 \$
6901 ZZ-C3 Rulman	2.00 \$



6200 ZZ-C3 Rulman	0.92 \$
6201 ZZ-C3 Rulman	0.95 \$
6202 ZZ-C3 Rulman	1.10 \$
6203 ZZ-C3 Rulman	1.45 \$
6204 ZZ-C3 D Devir Rulman	1.15 \$
6204 ZZ-C3 Rulman	1.60 \$
6205 ZZ-C3 Rulman	1.75 \$
6206 ZZ-C3 Rulman	3.45 \$
6207 ZZ-C3 Rulman	4.75 \$
6208 ZZ-C3 Rulman	5.82 \$
6210 ZZ-C3 Rulman	7.28 \$
6212 ZZ-C3 Rulman	13.00 \$



6305 ZZ-C3 Rulman	4.00 \$
6306 ZZ-C3 Rulman	5.50 \$
6307 ZZ-C3 Rulman	7.00 \$

**HK Rulman**

HK 0810	5.00 \$
HK 1010	5.00 \$
HK 1012	5.00 \$



51100 ZZ-C3 Rulman	1.00 \$
51101 ZZ-C3 Rulman	1.00 \$
51102 ZZ-C3 Rulman	1.05 \$
51103 ZZ-C3 Rulman	1.10 \$
51104 ZZ-C3 Rulman	1.20 \$
51105 ZZ-C3 Rulman	1.45 \$
51106 ZZ-C3 Rulman	1.50 \$
51107 ZZ-C3 Rulman	1.90 \$
51108 ZZ-C3 Rulman	2.15 \$
51109 ZZ-C3 Rulman	2.65 \$
51110 ZZ-C3 Rulman	2.80 \$
51111 ZZ-C3 Rulman	3.15 \$
51112 ZZ-C3 Rulman	4.05 \$
51113 ZZ-C3 Rulman	4.75 \$
51114 ZZ-C3 Rulman	5.25 \$
51115 ZZ-C3 Rulman	6.30 \$
51116 ZZ-C3 Rulman	6.75 \$

51204 ZZ-C3 Rulman	1.50 \$
51205 ZZ-C3 Rulman	1.90 \$
51206 ZZ-C3 Rulman	2.15 \$
51207 ZZ-C3 Rulman	1.75 \$
51208 ZZ-C3 Rulman	3.50 \$
51209 ZZ-C3 Rulman	4.25 \$
51210 ZZ-C3 Rulman	4.70 \$
51211 ZZ-C3 Rulman	5.25 \$
51212 ZZ-C3 Rulman	7.25 \$
51213 ZZ-C3 Rulman	7.72 \$
51214 ZZ-C3 Rulman	9.00 \$
51215 ZZ-C3 Rulman	10.50 \$
51216 ZZ-C3 Rulman	11.60 \$

**Mermer Ocakları için Mermer Kesme Elmaslar****Piton Vida Kapalı**

16 x 30	1.35 TL
19 x 70	1.60 TL
20 x 80	2.30 TL
21 x 100	3.05 TL
22 x 130	3.85 TL

**Kamalar**

4 x 4 x 20	6.85 TL
4 x 4 x 30	6.85 TL
5 x 5 x 20	7.25 TL
5 x 5 x 35	7.50 TL
6 x 6 x 30	8.00 TL
6 x 6 x 40	8.20 TL
6 x 6 x 50	8.40 TL
8 x 7 x 50	12.35 TL
8 x 7 x 60	14.70 TL
8 x 7 x 80	19.45 TL
8 x 7 x 90	19.45 TL
10 x 8 x 40	13.75 TL
10 x 8 x 50	16.65 TL
10 x 8 x 60	18.90 TL
10 x 8 x 80	25.00 TL
12 x 8 x 50	17.50 TL
12 x 8 x 60	20.80 TL
12 x 8 x 70	24.15 TL
12 x 8 x 80	29.15 TL
12 x 8 x 90	30.00 TL

**Yarımay Kamalar**

4 x 4	10.95 TL
5 x 9	8.10 TL
6 x 9	9.00 TL
8 x 9	11.25 TL
8 x 11	14.00 TL
10 x 11	15.00 TL

**Küçük S Kanca, Büyük S Kanca**

2.30 TL
3.40 TL

**Halkalı Vida**

M 6	15.50 TL
M 8	28.50 TL
M 10	30.00 TL

**Halkalı Civata**

M 6	16.85 TL
M 8	22.95 TL
M 10	33.65 TL

**Halka**

No: 16 (iç çap:31 mm)	5.00 TL
No: 20 (iç çap:42 mm)	7.50 TL

Piton Vida

16 x 30	1.25 TL
18 x 60	1.55 TL
19 x 70	1.65 TL
20 x 80	2.00 TL
21 x 100	2.60 TL
22 x 130	3.40 TL
23 x 150	4.30 TL
24 x 175	4.90 TL



13022 0.71 \$/Çift
14x6x23 mm, yaylı, sigortalı
Bosch kömür

13024 0.71 \$/Çift
17x7 mm, yaylı, sigortalı, Dewalt

13016 0.74 \$/Çift
6.3x16x22 mm, telli, sigortalı
Bosch GSH 27 PWS 20-180, 24-180

13030 0.74 \$/Çift
Bosch 6-115, 9-115, 2/24, 2/26
Kömürü sigortalı,
8x5x15 mm

13031 0.62 \$/Çift
Bosch 7-115 Kömürü
Metabo W7-115, 9-115
10x5 mm, sigortalı

130011 0.62 \$/Çift
Bosch Yeni tip 7-115 Kömürü
8x5x15 mm, sigortalı, üstten soketli

Bosch Kömür Yeni Tip
10x6x16 mm 0.80 \$/Çift

13010 0.62 \$/Çift
Metabo Kırıcı Kömürü
sigortalı, 8x10x25 mm

13177 0.62 \$/Çift
Bosch Taşlama Kömürü
10x5 mm

13032 0.77 \$/Çift
Bosch GWS 180/GBN 11 kırıcı
Taşlama Kömürü, sigortalı,
6.3x16x22 mm

13009 0.74 \$/Çift
Metabo 180
Taşlama Kömürü 16x6 mm

13033 0.62 \$/Çift
Bosch Darbeli Matkap
Kömürü 6x6 mm

13070 0.77 \$/Çift
Makita Freze Kömürü
13x6 mm

13006 0.74 \$/Çift
Black Decker Telli, yadan
soketli, sigortalı
12x6 mm

13017 0.65 \$/Çift
Black Decker Soketli,
GBH 7/46 DE, 12x6 mm

13008 0.65 \$/Çift
Metabo Dewalt Taşlama kömürü,
telli, sigortalı
8x14x18 mm

L13039 1.38 €/Tek
5x10x17 mm
Bosch GWS 7-115

L13049 1.40 €/Tek
5x8x15 mm
Bosch GWS 6-115, 8-125, GWS 750

L13051 3.08 €/Tek
7x11x20 mm
Bosch GKS 190

L13079 2.58 €/Tek
5x8x15 mm, sigortalı
Bosch GWS 6-115, 8-125, 9-115

L13136 1.61 €/Tek
5x8x19 mm
Bosch GBH 2SE, GBH 2-24 DSE

L17036 2.05 €/Tek
5x8x11 mm
Makita CB 85

L13177 1.54 €/Tek
Bosch taşlama kömürü
10x5 mm

Akü Pil Hücresi 3.50 \$
1.2 V 1600 Amper

Kırıcı Delici Yağlama Gresi 1.25 \$
50 ml 15650

FELİSATTİ Titreşim Zımpara Tabanı 10.00 \$
Poliüretan taban No: 27

FELİSATTİ Titreşim Zımpara 14.00 \$
Alüminyum Tabanı
No : 15 + 18 + 19 + 20 + 21

Eltos
Taşlama Somun Anahtarı
Küçük TSA 001 100.00 TL
Büyük TSA 002 112.00 TL

Eltos MDA 014 75.00 TL
Matkap Disk Aparatı

Eltos EKDS 042 86.00 TL
Konik Disk Altı Taşlama Somunu

Eltos ECS 044 134.00 TL
Çift Taşlama Somunu

Eltos DTA 043 92.00 TL
Daire Testere Aparatı

Eltos MTA 001 730.- TL
Matkap Taşlama Aparatı

Üniversal Mandren Adaptörü
(Daire Testere Aparatı)
Sol diş bağlantı adaptörü keçe,
zımpara taşı tel fırçaları matkap ile
kullanmak için 75.00 TL

Freze Adaptör
12 mm - 1/4 mm 2.50 \$
12 mm - 8 mm 2.50 \$
12 mm - 6 mm 2.50 \$
1/2" - 1/4" 2.50 \$

Freze Pensi
12 mm 5.00 \$
1/2" 5.00 \$

DT 18 Pens
3 mm 1.50 \$
6 mm 1.50 \$
8 mm 1.50 \$

LD 5 Konik Pens 1.65 \$
6 mm

DT 19 Metrik Somun 1.50 \$
14 mm

8.8 KALİTE ÇELİK CIVATALAR (UNC - UNF) ASA-B 18.2.1

Boy/mm	Boy/mm	1/4	5/16	3/8	7/16	1/2	9/16	5/8	3/4	7/8	1"
1/2	13										
5/8	16	1,3038	1,9718	2,9964							
3/4	19	1,3662	2,1277	3,2222	4,4916	6,9950					
7/8	22	1,4692	2,2658	3,3465	4,6372	7,1040					
1"	25	1,6093	2,3737	3,4222	5,1977	7,5612	9,8265	13,4193			
1 1/4	32	1,7160	2,7376	4,1556	5,8857	8,6526	11,1396	14,6328			
1 1/2	38	2,0412	3,1874	4,7318	6,9267	9,3922	12,1741	16,0160			
1 3/4	45	2,3607	3,6592	5,3132	7,5444	10,5668	13,6421	17,5750	26,2212		
2"	50	2,6711	4,0843	5,9204	8,4802	11,9599	15,0174	19,3227	28,1899	75,0000	108,0000
2 1/2	63.5		5,0152	7,1317	10,1433	13,9806	17,7145	22,8513	33,0907	87,0000	123,5000
3	75		5,9492	8,2324	11,7072	16,8433	20,6247	26,4534	36,3325	100,0000	132,5000
3 1/2	90			10,0014	13,6095	19,2281	24,4373	30,4014	41,7399	112,0000	149,0000
4	100			11,4646	15,3569	20,7040	27,2069	34,1526	46,6673	116,5000	159,0000
4 1/2	110			13,1591	16,7828	22,8101	54,0000	36,4572	49,7685	128,0000	174,0000
5	125			14,4747		45,0000	59,0000	49,4890	56,0944	140,0000	189,0000
5 1/2	140			15,8457		49,5000	65,0000	81,0000	60,1492	151,2000	205,0000
6	150					53,3000	70,0000	87,0000	66,4237	162,5000	219,0000



8.8 KALİTE ÇELİK CIVATALAR (DIN 931 - 933)

	M5	M6	M7	M8	M10	M12	M14	M16	M18	M20	M22	M24
10	0,7767	1,1251		1,8570								
12	0,7781	1,0507	1,3838	1,8743								
15	0,7699	1,0132	1,5248	1,9004	3,3729							
16	0,812	1,0132	1,5309	1,9004	3,3729							
18	0,8761	1,0697	1,6507	2,0100	3,4343							
20	0,8954	1,0851	1,6646	2,1163	3,5223	4,8407						
25	0,9893	1,2434	1,8489	2,3960	3,6982	5,3071	8,4998	11,0248				
30	1,1349	1,5047	2,0476	2,5915	4,0919	5,8894	9,0330	11,8763				
35	1,2731	1,7065	2,2644	2,8772	4,4813	6,4385	9,8653	12,8126				
40	1,5842	1,8245	2,4371	3,1764	5,4804	7,0132	10,6158	13,7527	20,1576	23,7564		
45	1,7443	2,0191	2,9127	3,4724	6,1536	8,4306	11,4453	14,7802	20,6393	25,0425		
50	1,8973	2,2008	3,1651	3,7581	6,4401	9,1188	12,8181	15,6587	22,8178	26,7177	42,1577	43,8601
55		2,3980	3,5261	4,0478	6,8242	9,8167	13,7426	17,5852	24,3071	28,4442	44,6135	46,1678
60		2,5965	3,8248	4,3501	7,3292	10,5182	14,7132	18,6739	25,8404	29,9684	45,2598	47,9651
65		2,8394		4,6754	7,8007	11,2453	15,4890	19,9537	27,6316	31,4863	47,5236	49,7586
70		2,9513		4,9943	8,3013	11,6670	16,4718	21,0706	29,0575	35,2491	49,9169	51,8235
75		3,3955		5,3304	8,7875	12,3402	17,4938	22,3104	30,9171	37,1351	52,3739	54,8246
80		3,7278		5,5697	9,3131	13,0632	18,2668	23,5040	32,3295	38,6557	54,6999	61,1436
90		5,0184		6,2163	10,2585	14,3858	19,7682	25,9750	35,8106	42,3425	59,6154	66,3157
100		6,2190		6,8242	11,2585	15,7440	21,7672	28,2510	38,7585	46,7235	64,2697	71,8416
110		7,3633		7,7011	12,5562	16,9793	23,6539	30,6494	42,0454	49,8882	74,9526	77,485
120		8,6993		8,7355	13,5799	18,4065	25,5692	33,0732	47,5841	53,5761	77,8528	82,8344
130		9,4838		9,3954	14,5825	20,5732	28,5911	34,8874	50,3849	57,126	81,4955	87,6209
140		10,1771		10,1762	15,9723	22,9017	30,3782	37,7897	51,4008	61,6461	86,8499	94,7158
150		11,2907		11,1275	20,0301	24,7440	32,2919	41,1948	56,7265	65,4347	92,3518	99,4906
160					20,8227	29,9028	45,5996	43,9765	62,5066	69,8994	97,7058	105,09
170					22,5608	32,4036	48,1691	48,0712	68,3805	76,6608	103,2064	113,2742
180					23,7777	34,1564	51,8919	52,6875	75,3318	83,3765	108,7102	119,007
190					26,2147	37,6597	55,7294	57,7280	83,0214	86,9052	114,0632	124,6017
200					27,4925	39,4990	59,6857	60,2039	91,4975	94,9134	123,7306	130,3387



İMBUS CIVATALAR (DIN 912)

	3	4	5	6	8	10	12	14	16	18	20	22	24
8	0,9730	1,1227	1,1806										
10	0,9730	0,7639	1,1866	1,3042	3,0810								
12	1,0588	0,7071	1,0205	1,1696	2,1963								
16	1,2927	0,6966	0,8699	1,1970	2,1031	3,6838							
20	1,4660	0,7636	0,9939	1,2297	2,2719	3,7624	5,4834						
25	1,7316	0,9022	1,1431	1,3862	2,4482	4,1143	5,8370	11,6491					
30	2,0071	1,0031	1,3137	1,5021	2,7301	4,5003	6,3449	8,6161	15,2686				
35	2,7843	1,1443	1,4801	1,8343	3,0882	4,9980	6,8984	9,4864	14,1863				
40	3,0402	1,2762	1,7158	1,9672	3,3831	5,3885	7,4812	10,3837	14,6221	34,4061	26,2618		
45		2,6800	1,9106	2,1694	3,7199	5,9375	8,2527	10,9772	15,6976	36,8166	28,5402		
50		2,7843	2,3727	2,3555	4,0177	6,4540	8,7601	11,7963	17,0239	39,2566	27,7256	66,6674	
60		4,8997	3,3255	2,7913	4,8003	7,5035	10,3167	13,6018	19,6028	44,0383	31,1766	73,6332	58,5363
70		5,2539	10,0355	3,4164	5,3692	8,5069	11,4997	15,4458	22,3112	48,8789	35,3932	81,6026	64,4491
80		6,5428	10,5471	3,9991	6,0011	9,6109	12,9342	17,5676	24,7561	54,0935	39,4345	89,6311	69,8750
90			14,7582	4,4350	6,7154	10,6493	14,3918	19,6646	28,0002	59,4655	43,6664	97,5808	76,3103
100			15,4469	4,8695	7,4879	11,6481	15,9008	21,6793	29,9176	64,8571	47,6550	105,6288	82,4550
110				5,5936	8,3772	12,8685	17,2936	23,6721	33,5556	70,2094	52,4720		89,0335
120				7,2200	9,0664	13,9920	18,8844	25,6386	35,9798	75,6010	56,7860	121,6464	95,1841
130				8,1045	11,7759	15,5871	20,6001	27,6121	38,6493	80,9139	61,1595	129,6747	102,7714
140				9,2602	12,8453	16,7121	22,1527	29,5831	41,4490	86,1285	65,5041	137,6048	113,5308
150					14,1310	18,4218	25,0303	33,7675	44,7011	91,5004	69,7891	145,6726	121,2636
160						19,5462			47,8833	96,8527	74,4442	153,6026	135,6260
170									49,4755	102,3821	78,9738		160,5052
180									50,9944	107,3604	83,5020	169,6201	167,3733
200										118,1241	173,6539	202,0290	221,6671



HAVŞA BAŞ İMBUS CIVATALAR (DIN 7991)

SETİSKUR CIVATALAR (DIN 916)

	M4	M5	M6	M8	M10	M12	M16		M3	M4	M5	M6	M8	M10	M12	M16
10	0,9249	0,8423	1,2200					6	0,3850	0,2930	0,3780	0,4708				
12	1,0527	0,8423	0,9838	1,9973				8	0,4650	0,3750	0,4270	0,5200	0,8070			
16	1,3440	0,8614	0,9930	2,0253				10	0,6000	0,4810	0,5580	0,6875	1,0800	1,4000	2,6740	
20	1,4395	0,9415	1,0718	2,0667	3,4819			12	0,7350	0,5870	0,6900	0,7978	1,2490	1,8050	3,0550	
25	1,5742	1,0696	1,2337	2,2373	3,5758	6,8919		16	1,0750	0,8000	0,9520	1,1095	1,7500	2,5700	3,6500	6,6500
30	1,7651	1,2781	1,4197	2,4509	4,0700	7,0382		20	1,3640	1,0100	1,2150	1,4200	2,1600	3,3280	4,7600	8,7300
35	1,9875	1,5052	1,6163	2,8008	4,4959	7,5529		25		1,6900	1,7500	1,8140	2,7700	4,2750	6,5300	11,4000
40	2,2235	1,7144	2,0267	3,1181	4,9492	8,2015	17,7863	30			2,1100	2,2060	3,3750	5,2300	8,0000	14,2000
50	3,0304	2,2955	2,9890	4,3315	6,1550	9,2572	21,6557	35				2,5960	3,9700	6,1900	9,4800	16,9200
60		2,4991	3,9651	5,1731	7,4726	11,2147	25,0204	40				3,1020	4,9650	7,8000	10,9600	20,2500
70			5,2932	5,8752	8,6255	13,0022	30,7612	50						10,3100	14,5000	25,0100
80			6,0804	9,5830	9,7642	15,0791	35,9050	60								
90							41,0725	70								



YARIKLI PİM (DIN 1481)

	8	10	12	16	18	20	22	24	26	28	30	32	36	40
3	0,3147	0,3316	0,3418	0,3658	0,4312	0,4694	0,5192	0,5530	0,5854	0,6230	0,6526	0,6900		
4	0,5811	0,5975	0,6230	0,6526	0,7072	0,7736	0,7953	0,8507	0,9172	0,9844	1,0611	1,0728	1,2602	1,3524
5	0,8341	0,8293	0,8564	0,9391	1,0676	1,1340	1,1830	1,2788	1,3822	1,5482	1,5698	1,6587	1,8521	2,0340
6	0,9955	1,0095	1,0215	1,2999	1,4591	1,5920	1,7284	1,7965	1,9494	2,1265	2,2448	2,3774	2,6538	2,9303
8		1,9683	2,0120	2,1693	2,2459	3,3179	3,5428	3,8151	3,8705	4,0083	4,0802	4,1469	4,7553	4,9764

6x8 KALİTE ÇELİK SOMUNLAR (UNF-UNC) ASA-B 18.2.2

1/4	5/16	3/8	7/16	1/2	9/16	5/8	3/4	7/8	1"	1/2wh
0.6385	0.9082	1,3523	2.1621	2.8666	4.5013	5.6043	8.8329	30,000	43.500	2.9041

**6x8 KALİTE METRİK ÇELİK SOMUNLAR (DIN 934)**

M3	M4	M5	M6	M7	M8	M10	M12	M14	M16	M18	M20	M22	M24	M27	M30	M36
0,2300	0,2418	0,2588	0,4593	0,5763	0,7922	1,6609	2,4361	3,4957	4,6596	6,8982	8,4813	11,909	15,5121	31,0095	41,7758	75,000

6x8 KALİTE METRİK İNCE DİŞ ÇELİK SOMUNLAR (DIN 934)

8x1	10x1	10	12	12	14	16	18	20	22	24
		1.25	1.25	1.5	1.5	1.5	1.5	1.5	1.5	1.5
0.8537	1.7435	1.7435	2.5796	2.5796	3.7662	5.0182	7.5575	9.2926	12.8319	33.000

**FİBERLİ SOMUNLAR (DIN 985)**

1/4	5/16	3/8	7/16	1/2	9/16	5/8	3/4	7/8	1"		M3	M4	M5	M6		
1.2939	1.6279	2.6555	4.000	8.670	12.250	16.30	22.580	42.500	58.450		0.6310	0.6920	0.7060	0.8197		
M8	M10	M10x1.0	M10x1.25	M12x1.25	M12x1.5	M12	M14	M14x1*5	M16	M16x1.5	M18x1.5	M18	M20x1.5	M20	M22	M24
1.25	1.5					1.75	14*2	14*1.5	16*2	16*1.5	18*1.5	18*2.5	20*1.5	20*2.5	22*2.5	24*3
1.1276	2.2462	2.4007	2.3781	3.4910	3.3523	3.2745	5.0194	5.0618	6.2017	6.4884	9.8685	9.4065	13.7884	13.7249	32.050	37.2692

ALTİKÖŞE KAYNAK SOMUNLAR (DIN 929)

M5x0.8	M6x1	M8x1.25	M10x1.5	M12x1.75
1.5500	0.6505	1.0681	1.8973	2.7488

İTHAL KELEBEK SOMUNLAR (DIN 315)

M4	M5	M6	M8	M10	M12
2,4645	2,820	4,110	5,160	7,4250	14,7180

**TAKVİYELİ ÇELİK SOMUNLAR (DIN 6330)**

M6x1	M8	M10	M12	M14	M16	M20	M22	M24		
	3.040	6.250	8.400	13.600	16.700	31.100	38.000	57.000		
5/16	3/8	7/16	1/2	9/16	5/8	3/4	7/8			
3.250	1.8127	4.6654	4.2413	13.250	16.400	21.200	37.800			

AĞAÇ SOMUNLAR (DIN 1624)

M5	M6	M8	M10	5/16
2,750	1,1791	1,7484	6,050	1,7484

FLANŞLI SOMUN (DIN 6923)

M5	M6	M8	M10	M12	M16
1,0082	0,7010	1,4066	2,3082	3,6432	11,4476

KONTRA SOMUNLAR (DIN 439-936)

M6x1	M8x1	M8x1.25	M10x1	M10x1.25	M10x1.5	M12x1.25	M12x1.5	M12x1.75	M14x1.5	M14x2	M16x1.5	M16x2	M20x1.5	M20x2.5
0.4628	0.7792	0.8628	1.5699	1.5699	1.4760	1.9712	1.9712	1.9138	3.1860	2.8853	3.5933	3.2741	7.3232	6.6740

DÜZ GRASÖRLÜKLER H1 (DIN 71412)

1/4	5/16	3/8	7/16	1/2	M6	M8	M10	R 1/8	R 1/4
5,635	6,243	7,988	13,219	22,15	7,22	7,426	10,799	13,388	32,895

KÖR SOMUNLAR (DIN 1587)

M5	M6	M8	M10	M12
1,220	1,730	3,100	7,15	11,000

EĞRİ GRASÖRLÜKLER H2 45° (DIN 71412)

1/4	5/16	3/8	7/16	1/2	M6	M8	M10	R 1/8	R 1/4
12,969	12,969	15,444	25,143	37,799	18,329	18,329	25,539	30,363	50,504

EĞRİ GRASÖRLÜKLER H3 90° (DIN 71412)

1/4	5/16	3/8	7/16	1/2	M6	M8	M10	R 1/8	R 1/4
15,444	15,444	17,914	29,495	48,994	23,614	23,614	29,25	37,881	58,031

UZATMA SOMUNU (DIN 6334)

M6x40	M8x40	M10x40	M12x40	M16x40
9,1050	13,575	23,925	27,840	43,350

GİJON BEYAZ (DIN 975)**GİJONLAR (DIN 975)**

3/16	1/4	5/16	3/8	7/16	1/2	9/16	5/8	3/4	7/8	1	1 1/8	1 1/4	1 1/2
13.00	17.75	23.05	35.65	48.21	61.50	77.00	99.25	149.60	209.00	271.70			
M6	M8	M10	M12	M14	M16	M18	M20	M22	M24	M27	M30	M33	M36
15.30	23.20	36.35	53.15	74.10	98.60	122.50	156.50	189.40	227.80	293.70	377.30	451.00	550.00

PERÇİN SOMUNLARI (ALTİKÖŞE GÖVDE) FLANŞLI VE SIFIR KAFA

M3	M4	M5	M6	M8	M10	M12
1,300	1,300	1,1763	1,4390	2,1582	3,7256	

PERÇİN SOMUNLARI (YUVARLAK GÖVDE) FLANŞLI VE SIFIR KAFA

M3	M4	M5	M6	M8	M10	M12
1,2188	1,2188	1,2188	1,5329	2,0946	3,0812	

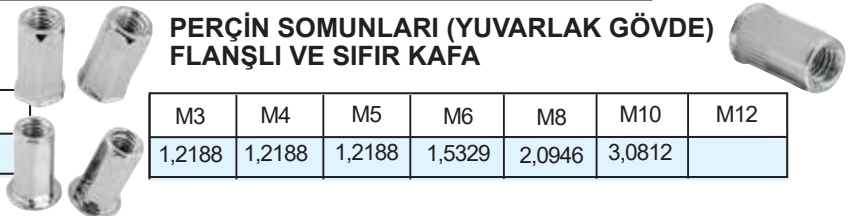

8.8 KALİTE ÇELİK İNCE DİŞ ÇELİK CİVATALAR (DIN 960 - 961)

	M10x1.25	M12x1.25 x1.50	M14x1.5	M16x1.5	M18x1.5x 2	M20x1.5 x2
10						
12						
15						
16						
18						
20	3,9801	5,5142				
25	4,2793	6,0032	9,4109			
30	4,6995	6,6740	9,7675	13,1991		
35	5,2478	7,3556	10,7250	14,2178		
40	5,7888	7,8987	11,4916	15,1428	22,6714	26,3619
45	6,3299	9,0424	12,3322	16,3484	23,2476	28,0641
50	7,0346	9,6449	13,7002	17,6933	24,4599	30,7509
55	7,3927	10,4770	14,9182	19,0422	25,8421	32,5433
60	7,8781	11,0929	15,7138	20,5003	27,6965	34,2683
65	8,4415	12,0160	16,8575	21,6715	29,4320	36,3941
70	8,8771	12,6340	17,7424	23,1714	31,1303	38,3068
75	9,4678	13,2956	18,8918	24,1827	32,7639	40,3411
80	9,9620	14,1417	19,4451	25,3914	34,6886	42,3012
90	10,9725	15,7077	21,4741	27,7902	38,1828	46,2427
100	12,0221	17,1973	23,5516	30,5745	41,3106	50,9925
110	13,7006	18,7740	25,3617	36,0797	45,9749	54,3565
120	15,2147	19,6240	28,1190	39,4182	50,6498	58,2144
130	16,8543	24,3704	35,0412	42,6065	54,5799	61,6759
140	18,2707	27,1306	38,9775	46,0218	59,8599	67,1782
150	22,9856	29,1038	41,5089	49,9583	65,9788	69,4968
160				54,5585	73,9950	75,8638
170				59,6047	80,2390	82,7886
180				65,1133	87,0460	90,2003
190				71,1247	94,2576	98,3476
200				77,6090	102,2834	107,3159

8.8 FLANŞLI ÇELİK CİVATA (DIN 6921)

	M5	M6	M8	M10	M12	M14	M16
12		1,6600	2,5266				
16	1,1013	1,4443	2,5798	5,2773			
18	1,3500	1,4892	2,7232	4,6009			
20	1,2119	1,4941	2,7888	4,7714			
25	1,4135	1,6660	3,0503	5,1792	8,3303		
30	1,6517	1,8891	3,3248	5,6180	9,1545		
35	1,8530	2,0848	3,7266	6,0236	9,7319	14,9133	
40	2,1469	2,2941	4,0732	6,7132	10,4146	15,3190	19,6084
45	2,4039	2,6068	4,4299	7,2625	11,1590	16,3807	21,0053
50		2,8596	4,8503	7,8340	12,1488	17,7527	22,2345
55		3,2052	5,4079	8,6741	12,8046	19,4637	24,3321
60		3,5923	5,6712	9,2757	13,7022	20,0405	25,2140
65		4,0466	6,1162	9,7869	14,4788	21,2210	26,5159
70		4,2856	6,5265	10,3360	15,3738	22,5147	27,6566
75		4,6582	6,8778	10,9348	16,2815	23,6770	29,3633
80			7,6581	11,7921	17,1665	24,9593	32,0682
85			8,3856	12,6166	18,8054	27,1466	35,0975
90			8,4539	12,9628	19,0403	27,4636	35,2591
100			9,2469	15,0902	20,8124	30,0332	38,2889
110			10,0888		22,4266		43,7136
120			10,9461			34,8587	47,8939
130						37,6941	52,0773
140						40,4429	57,0474

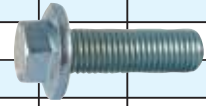

İNCE KAFA İMBUS CİVATA (DIN 7984)

	M5	M6	M8	M10	M12
10		1,2441			
12		1,2547			
14	1,1824	1,1712			
16	1,1916	1,1838	2,3010	4,5841	
20	1,2939	1,2670	2,3989	4,1652	6,3209
25	1,4818	1,4993	2,6809	4,3393	6,1420
30	1,6673	1,7550	3,1336	4,6209	6,5514
35	1,8913	2,0098	3,6025	5,0458	7,2178
40	2,1105	2,2677	4,0744	5,5365	8,1112
45	2,4408	2,6451	4,8503	6,0755	9,3026
50	3,4042	3,1291	5,6421	6,7573	10,2920
55			6,3690	8,2147	12,1911
60			7,1600	9,1790	14,1108
70					17,3185
80					21,4580
90					27,5866
100					32,4067



TABLALI SOMUN TL/ADET

M6	1,2363
M8	1,5611
M10	1,9396
5/16	1,5611
3/8	1,9396



TAVA CİVATASI

M6x12	M6x15	M8x15
0.6510	0.7222	1.1476

YB ve HB PULLUK VE KASA CİVATALARI

6 mm YB	8 mm YB	10 mm YB
108,00	108,00	108,00

10.9 BB BOMBE BAŞ İMBUS CİVATA (DIN 7380)

	M5	M6	M8	M10	M12
10	1,0641				
12	1,004	1,3485	3,1729		
16	1,0438	1,2761	2,5218	5,7326	
20	1,2282	1,3504	2,6312	4,6299	8,1395
25	1,4665	1,4162	2,7916	4,8348	8,2810
30	1,6975	1,6694	3,0648	5,1573	8,7345
35	1,9322	1,8754	3,4906	5,7362	9,5037
40	2,2892	2,0998	3,6598	6,32	10,2701
45	3,1008	2,6133	4,1525	6,9069	11,3514
50	3,7608	3,2902	4,8853	7,5839	12,4993
55			5,9727	8,9858	14,0543
60			7,3193		16,2226
70					19,0924



8.8 UNF BIÇAK CİVATASI

	35	40	45	50	60	70
7/16	5,5462	6,3151	6,9517	7,5440	9,2580	11,5950

KG DEMİR SOMUNLAR

	1/2	5/8	3/4	7/8
	130,00	130,00	155,00	155,00

KG DEMİR PERÇİNLER (DIN 660-661)

	3	3,5	4	5-6	8	10-12
	111,50	111,50	111,50	111,50	111,50	111,50

KG DEMİR CİVATALAR

	3/8	7/16	1/2	5/8	3/4
	118,00	118,00	118,00	195,00	195,00

6.8 AKB DEMİR CİVATALAR

	15	20	25	30	35	40	45	50	60	70	80	90	100
5/16	1,40	1,45	1,65	1,80	1,95	2,20	2,35	2,50	2,85	3,30	3,85	4,20	4,40
M8	1,40	1,45	1,65	1,80	1,95	2,20	2,35	2,50	2,85	3,30	3,85	4,20	4,40

PASLANMAZ İMBUS A2 (DIN 912)

	M4	M5	M6	M8	M10	M12	M14	M16	M20
8	1,350	2,000							
10	1,400	1,850	2,700	7,250					
12	1,500	1,900	2,750	5,650					
16	1,700	2,000	3,000	5,800	10,00				
20	1,850	2,350	3,250	6,450	10,50	15,75			
25	2,300	2,800	3,800	6,850	11,60	16,25		45,00	
30	2,650	3,450	4,150	7,650	12,85	18,00	33,10	39,00	
35	3,000	3,900	5,250	8,600	14,00	19,75	36,35	42,00	
40	3,400	4,350	5,800	9,500	15,10	21,50	38,15	46,00	97,50
45	4,200	4,950	6,400	10,450	16,60	23,00	39,25	49,00	105,00
50	4,400	5,300	6,900	11,350	18,25	25,00	41,75	53,50	110,00
60		6,500	8,200	13,200	21,25	30,50	50,50	61,50	125,00
70		7,500	9,250	16,000	25,50	36,25	60,50	76,50	145,00
80		21,15	10,450	18,900	28,50	41,00	68,00	85,50	170,00
90		26,50	13,900	22,000	31,75	44,75	75,50	95,00	190,00
100		29,50	14,800	24,000	34,50	49,75	83,00	103,50	210,00
110			24,850	28,750	43,60	57,25	99,50	124,00	240,00
120			26,250	31,000	47,00	64,50	109,50	134,00	260,00
130			30,000	33,500	50,75	69,50	118,50	144,00	280,00
140				35,750	54,00	74,50	127,25	154,00	300,00
150				42,750	57,50	80,00	190,00	195,00	330,00

**PASLANMAZ CİVATALAR A2 (DIN 931/933)**

	M3	M4	M5	M6	M8	M10	M12	M14	M16	M18	M20	M24
10	7,10	1,55	1,60	2,00	4,50							
12	7,30	1,60	1,65	2,20	4,65							
16	7,80	1,80	2,00	2,35	4,70	9,05						
20	8,05	2,10	2,25	2,65	5,25	9,20	13,90	31,75				
25	8,40	2,35	2,65	3,10	5,90	10,30	14,80	27,00	39,00			
30	8,55	2,70	3,00	3,55	6,65	11,30	16,40	26,75	32,25			
35	9,90	3,15	3,40	3,95	7,30	12,55	17,90	29,00	36,75			
40	11,20	3,50	3,75	4,30	8,10	13,50	19,45	31,40	39,75		69,50	
45	15,65	4,25	4,50	4,80	8,70	14,55	21,05	33,85	42,95		73,50	
50	16,60	4,50	4,95	5,20	9,35	15,65	22,40	36,10	44,90	75,00	80,00	135,00
60			5,75	6,15	10,90	17,90	25,30	40,75	51,45	84,50	89,00	145,00
70			8,25	7,20	12,20	20,15	28,70	45,30	56,60	93,00	98,75	160,00
80			13,65	8,10	13,60	22,40	32,40	49,50	63,05	102,50	108,25	175,00
90				9,40	16,20	24,30	35,30	54,25	69,50	111,25	117,25	189,00
100				10,40	17,45	27,00	38,55	58,75	75,65	120,00	126,50	202,50
110				13,45	21,00	31,60	44,20	79,25	86,75	148,75	141,00	234,50
120				14,70	22,60	34,15	47,50	85,00	93,00	159,00	150,50	249,50
130				18,15	29,25	42,50	57,50	90,50	102,00	169,85	160,00	270,00
140					33,13	45,25	61,25	96,50	107,75	180,00	171,25	285,00
150					35,75	52,50	67,50	108,50	122,00	200,00	191,25	320,00

PASLANMAZ SETİSKURLAR A2 (DIN 916)

	M4	M5	M6	M8	M10	M12	M16
6	0,60	0,75	0,85				
8	0,73	0,83	0,90	1,70			
10	0,78	0,90	1,25	1,90	3,10		
12	0,88	1,05	1,40	2,35	3,75	5,75	
16	1,05	1,33	1,95	3,25	5,15	7,00	
20	1,40	1,70	2,50	3,85	6,25	9,25	
25		2,40	2,90	4,95	8,00	12,40	
30		3,00	3,60	6,90	10,00	14,90	37,50
35		3,75	4,50	7,25	11,50	18,25	44,25
40		5,25	6,20	10,00	15,25	23,40	52,50
50						30,00	66,50

PASLANMAZ HAVŞA BAŞ İMBUS A2 (DIN 7991)

	M4	M5	M6	M8	M10	M12	M16
10	1,00	1,45	1,90	5,00			
12	1,05	1,55	1,95	4,00			
16	1,10	1,65	2,10	3,95	9,25		
20	1,30	1,90	2,45	4,45	7,35	16,00	
25	1,50	2,10	2,80	5,30	8,70	14,00	
30	2,00	2,60	3,25	6,05	10,00	14,50	40,00
35	2,25	3,40	3,80	6,90	11,35	16,30	41,75
40	2,65	3,60	4,75	7,65	12,65	18,25	43,50
50		4,35	6,25	10,25	15,80	21,75	45,00
60		6,50	8,00	12,80	20,00	29,00	55,00
70			9,40	15,30	23,00	34,00	65,00

PASLANMAZ YHB A2 METRİK VİDALAR (DIN 965)

	8	10	12	16	20	25	30	35	40	45	50	60
M3	0,55	0,65	0,75	0,80	0,95	1,15	1,25	1,80	2,00	2,65	4,15	7,25
M4	0,75	0,80	1,00	1,10	1,35	1,70	1,95	2,05	2,45	2,70	3,20	4,05
M5	1,15	1,35	1,55	1,75	2,20	2,60	3,05	3,40	3,95	4,30	4,75	5,80
M6	3,60	1,95	2,20	2,80	3,30	3,85	4,45	5,10	5,90	6,40	7,10	8,60

**PASLANMAZ YSB A2 METRİK VİDALAR (DIN 7985)**

	6	8	10	12	16	20	25	30	35	40	45	50
M3	0,70	0,75	0,80	0,88	1,00	1,10	1,30	1,50	1,90	2,05	2,35	2,85
M4	1,20	1,25	1,30	1,38	1,60	1,80	2,10	2,50	2,70	3,00	3,25	3,75
M5	2,90	1,95	2,05	2,30	2,65	2,85	3,30	3,75	4,65	4,85	5,00	5,35
M6		3,75	3,85	4,05	4,15	4,80	5,40	5,70	6,35	7,40	8,00	8,75

**PASLANMAZ YHB A2 SAÇ VİDALAR (DIN 7982)**

	9,5	13	16	19	22	25	32	38	45	50	60	70
2.9	0,50	0,48	0,58	0,68	0,78							
3.5	0,55	0,68	0,78	0,90	0,98	1,05	1,30	1,50				
3.9	0,68	0,75	0,85	1,00	1,15	1,30	1,48	1,70	2,05	2,35	2,75	
4.2	0,78	0,88	1,00	1,05	1,28	1,40	1,65	1,98	2,35	2,60	3,60	4,90
4.8	0,85	1,15	1,30	1,60	1,80	1,90	2,30	2,40	2,95	3,30	3,95	5,45
5.5		1,80	2,10	2,35	2,60	2,85	3,45	3,90	4,55	5,10	6,10	7,85

**PASLANMAZ YSB A2 SAÇ VİDALAR (DIN 7981)**

	9,5	13	16	19	22	25	32	38	45	50	60	70
2.9	0,50	0,60	0,65	0,70	0,75							
3.5	0,68	0,83	0,90	0,98	1,05	1,15	1,35	1,70				
3.9	0,90	1,00	1,10	1,20	1,30	1,35	1,58	2,05				
4.2	0,85	1,05	1,30	1,38	1,55	1,70	1,95	2,30	2,60	2,90		
4.8	1,35	1,50	1,80	1,90	2,05	2,30	2,70	3,00	3,40	3,70	4,35	5,90
5.5		2,45	2,75	2,85	2,95	3,25	3,90	4,45	4,80	5,50	6,60	7,80

**A2 INOX TORX SB VİDA (DIN 7985 TX)**

	M3	M4	M5	M6
10	2,55	4,65	4,75	5,50
12	2,80	4,75	4,90	5,95
16	3,00	5,10	5,25	6,75
20	3,30	5,50	5,65	6,95
25	4,00	5,80	6,00	7,15
30		6,00	6,30	

PASLANMAZ KÖR SOMUNLAR (DIN 1587)

M4	M5	M6	M8	M10	M12	M14	M16	M18
1,98	2,05	3,20	5,90	11,40	18,45	38,50	40,00	

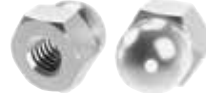
**PASLANMAZ ALTİKÖŞE KAYNAK SOMUN (DIN 929/A2)**

M4	M5	M6	M8	M10	M12	M16
2,30	2,40	2,70	4,40	10,75	16,45	43,65

**PASLANMAZ GİJONLAR A2 (DIN 975)**

M6	M8	M10	M12	M14	M16	M18	M20
76,95	115,90	180,50	258,90	349,15	479,70	619,90	751,15

PASLANMAZ SOMUNLAR A2 (DIN 934)

M3	M4	M5	M6	M8	M10	M12	M14	M16	M18	M20
0,45	0,53	0,70	1,10	2,25	4,95	7,25	10,55	14,10	22,35	26,35

**PASLANMAZ DÜZ RONDELALAR A2 (DIN 125-A2)**

M4	M5	M6	M8	M10	M12	M14	M16	M18	M20
0,33	0,40	0,61	0,94	1,69	3,38	4,68	5,38	6,63	7,68

PASLANMAZ FİBERLİ SOMUNLAR A2 (DIN 985)

M5	M6	M8	M10	M12	M14	M16	M20
1,05	1,38	2,90	5,75	9,20	14,70	18,45	47,00

KOPİLYA (DIN 94) TL/ADET

	15	20	25	30	35	40	45	50	60	70	80	90	100
2	0,115	0,150	0,180	0,210	0,260	0,275	0,340	0,440					
2.5	0,190	0,200	0,235	0,250	0,280	0,325	0,360	0,450					
3	0,250	0,275	0,325	0,380	0,400	0,410	0,550	0,590	0,760	0,900			
3.5	0,280	0,290	0,420	0,545	0,550	0,625	0,700	0,750	0,980	1,250			
4		0,500	0,510	0,545	0,590	0,680	0,780	0,810	1,000	1,125	1,230	1,365	1,480
5		0,740	0,780	0,845	0,995	1,050	1,150	1,235	1,480	1,640	1,870	2,185	2,340
6			1,190	1,350	1,450	1,655	1,930	2,00	2,280	2,600	2,900	3,355	3,650
8						2,780	3,100	3,300	3,820	4,525	4,990	5,400	5,890
10						5,950	6,050	6,970	8,500	9,750	10,95	11,44	12,225

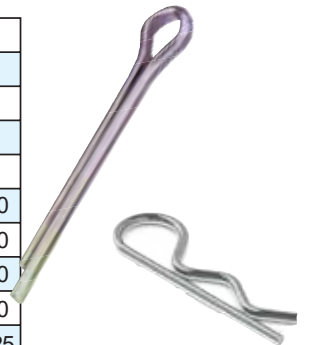

FİRKETE
3 mm 3,10

TRİFON VİDALAR (DIN 571)

	30	40	50	60	70	80	90	100	110	120
1/4 (M6)	1,390	1,660	1,860	2,100	2,370	2,660	2,970	3,350		
5/16 (M8)		2,400	2,850	3,050	3,420	4,100	4,540	4,900	5,300	5,950
3/8 (M10)		4,320	4,960	5,510	6,050	6,650	7,350	8,030	8,690	9,350



YSB - YHB SAÇ VİDALARI (DIN 7981 - 7982)

	6.5	9.5	13	16	19	22	25	32	38	45	50	60
2.9	0,3113	0,3207	0,3113	0,3628	0,4119	0,4354	0,4869	0,5477				
3.5	0,3254	0,3628	0,4237	0,4354	0,5103	0,5361	0,5993	0,6976	0,9332			
3.9	0,4237	0,4112	0,4494	0,5103	0,6227	0,6718	0,7350	0,8099	0,8965			
4.2	0,5244	0,4729	0,5477	0,5993	0,7350	0,7608	0,7982	0,9332	1,0581	1,2453	1,3694	
4.8		0,6226	0,6858	0,7725	0,8848	0,9597	1,0581	1,3062	1,4935	1,5566	1,7416	2,1161
5.5			0,9410	1,0581	1,1213	1,2453	1,4935	1,8656	1,9920	2,1161	2,3010	2,9237
6.3					1,4326	1,4935	1,6175	1,9920	2,2402	2,7364	2,9237	3,1109

YSB - YHB METRİK DEMİR VİDALAR (DIN 7985 - 965)

	6	8	10	12	15	20	25	30	35	40	45	50	60
3	0,2107	0,2213	0,2318	0,2634	0,2740	0,3161	0,3371	0,4109	0,5584	0,63216	0,8323	0,9482	1,0540
4	0,3131	0,3231	0,3332	0,3433	0,3837	0,4443	0,5048	0,5654	0,6563	0,6765	0,7371	0,8078	1,0602
5	0,5058	0,4847	0,5048	0,5352	0,5957	0,6664	0,7472	0,8280	0,9289	0,9895	1,1107	1,2117	1,4642
6	0,8429	0,7902	0,8078	0,8078	0,8583	0,9593	1,0602	1,1612	1,2622	1,5146	1,6660	1,7670	1,9184
8 YSB					1,7670	2,0194	2,2214	2,4233	2,7262	2,9281	3,0291	3,3321	3,6350
8 YHB					1,7670	2,0194	2,2214	2,4233	2,7262	2,9281	3,0291	3,3321	3,6350

YMB SAÇ VİDALARI (DIN 7983)

	6.5	9.5	13	16	19	22	25	32	38	45	50	60
2.9	0,3779	0,3365	0,3511	0,4023	0,4535	0,4926	0,5852	0,8900				
3.5	0,4023	0,3901	0,4267	0,4804	0,5706	0,5974	0,6486	0,7778	1,0119			
3.9	0,5072	0,4926	0,4804	0,5706	0,6876	0,7388	0,7535	0,8437	0,9997			
4.2		0,5072	0,5706	0,6486	0,7388	0,8168	0,9339	1,1021	1,2582			
4.8		0,7144	0,7388	0,8559	0,9607	1,0363	1,1021	1,3606	1,4264			

RYSB SAÇ VİDALARI (DIN 968)

3.9x13	0,4804
3.9x16	0,5706
3.9x19	0,6876
3.9x25	0,7534
3.9x32	0,8437

YMB METRİK VİDALARI (DIN 966)

	10	12	16	20	25	30	35	40	45	50		
5	0,9371	1,0008	1,0642	1,1913	1,3502	1,4773						
6	1,3502	1,4296	1,5090	1,6679	1,8267	1,9856	2,2238	2,5416	2,7798	3,0975		

AY TİPİ SEGMAN (DIN 6799)

1.5	1.9	2.3	3.2	4	5	6	7	8	9	10	12	15	30		
0,1375	0,1375	0,15	0,1625	0,20	0,2625	0,325	0,4375	0,6125	0,75	1,00	1,375	2,9625	20,8875		

TIRNAKLI SEGMAN (D 02)

M3	M4	M5	M6	M7	M8	M9	M10
0,200	0,200	0,2625	0,3025	0,500	0,5125	0,7875	0,8125

EMNİYET SEGMANI (DIN 471 - 472)

EBAT	DIN 471	DIN 472	EBAT	DIN 471	DIN 472	EBAT	DIN 471	DIN 472	EBAT	DIN 471	DIN 472
4	0,3552		22	2,724	1,992	42	9,948	7,716	95		31,284
5	0,3552		24			45	10,896		100	47,628	33,336
6	0,4752		25	3,312	2,724	47			105		63,732
7	0,5916		26	3,792	3,000	48			110		
8	0,5916	0,5916	27	3,792	3,252	50	11,904	8,94	115		
9	0,7104	0,5916	28	4,056	3,516	52	12,912	9,42	120		
10	0,7104	0,7104	29			55	13,380	10,896	125		
11	0,8298	0,7104	30	4,284	4,032	58	16,884	12,912	130		
12	0,8298	0,7104	31	5,820	4,284	60	14,868	11,904	135		
13			32	5,820	4,284	62	16,668	11,904	140		100,38
14	1,0704	0,8280	33		4,968	65	20,844	16,68	150		
15	1,242	0,9960	34	6,192		68		19,8	160		
16	1,422	1,1400	35	6,192	4,656	70	22,860	19,8	170		
17	1,5396	1,2840	36	7,464	4,98	75	24,756	19,8	180		
18	1,896	1,4160	37	7,920	5,496	80	26,772	20,844	190		
19	2,124		38	7,920	5,712	85	34,716	27,036	200		
20	2,256	1,5600	39		6,036	90	38,676	28,68	210		
21	2,604	1,9920	40	8,100	6,924				220		

12.9 KALİTE METRİK ÇELİK İMBUS SİYAH (DIN 912)

	M3	M4	M5	M6	M8	M10	M12	M14	M16	M18	M20
8	1,9291	2,1668	2,3645	2,9958							
10	2,0337	1,9460	2,1550	2,3705	4,9153						
12	2,0970	1,9460	1,8592	2,1730	3,9981						
16	2,3783	1,8152	1,5838	2,1730	3,8283	6,5228					
20	2,5701	1,9513	1,8089	2,2327	4,1348	6,6601	10,9322				
25	2,9419	2,2690	2,0765	2,5214	4,3781	7,2800	10,3346	23,7429	32,1736		
30	3,2769	2,4959	2,3967	2,7248	4,8779	7,9685	11,0419	16,9907	27,7724		
35	4,5865	2,9407	2,6935	3,1906	5,5151	8,6387	12,1107	17,2585	26,1038		
40	5,3843	3,3354	3,1220	3,5760	5,9933	9,5422	13,0161	18,3854	24,7602	69,7451	47,7755
45		4,3729	4,0791	3,8464	6,6426	10,5149	14,6138	19,9672	26,4979		51,9170
50	6,6843	5,5318	4,3174	4,2811	7,1137	11,4275	15,5125	21,4546	28,7754	69,7451	52,3596
55				5,0724	8,7342	13,2864	18,2655	24,7412	34,7131		59,3130
60	8,1960	7,5578	7,7615	5,0724	8,7342	13,2864	18,2655	24,7412	34,7131	74,0714	59,3130
70	9,0141	12,1530	13,6550	6,1970	9,5056	15,0690	20,3622	28,1004	39,1639	80,9555	64,6243
80		16,4453	20,0528	7,3965	10,9149	17,0229	22,9022	31,9509	43,4546	89,8322	71,6142
90		20,6769	25,5217	11,3078	12,2177	19,6326	25,4861	34,8231	49,5796	99,9236	78,8000
100		22,1029	30,9907	12,9072	13,8478	21,8683	28,1544	38,3870	54,4229	105,5382	87,6060
110			41,3190	19,7612	18,1405	24,2247	31,2163	55,9351	61,0444	124,3170	95,4516
120		56,5857	51,6487	23,6822	21,4053	26,2740	35,0800	60,5914	65,4433	135,3323	103,299
130			58,6582	28,1153	31,1173	37,7080	47,4541	73,9669	83,9245	150,3476	111,257
140			61,9170	30,6592	33,8700	40,6010	51,3775	78,8604	90,0365	160,9531	119,160
150			65,1758	33,4103	37,4319	43,9497	59,7847	83,7148	94,5053	172,4941	126,956



YARIM PASO

TAM PASO

12.9 KALİTE METRİK ÇELİK CİVATA (DIN 933 - 931)

	M5	M6	M8	M10	M12	M14	M16	M18	M20
8									
10	2,5081	2,9516							
12	3,0849	3,1577							
16	3,0849	3,1577	4,4547	8,6578					
20	3,2486	3,5292	4,8239	8,2449	15,0663				
25	3,5733	3,9704	5,4146	9,0571	15,0663				
30	4,2228	4,4348	5,9314	9,8447	14,3486	26,0884	27,3900		
35		4,8759	6,3991	11,0753	15,5054	28,4601	30,7369		
40	5,1459	5,3403	7,0636	12,0705	16,6375	29,8831	31,6932		
45			7,6167	12,9439	17,9419	31,8986	33,7315		
50		6,3155	8,1711	14,3925	20,0832	33,9150	35,7687	66,7679	60,1532
55							40,2084		
60					22,3175	37,7097	40,2084	74,6224	66,2847
70							44,2612	85,0420	73,0445
80									79,2903



8.8 YB DİBİDÖRT KÖŞE CİVATA (DIN 603)

	M6	M8	M10	M12
16	1,7650	3,2050		
20	1,8860	3,5295	5,9956	9,9673
25	2,0646	3,9244	6,4969	10,8137
30	2,3884	4,3167	6,9766	11,6204
35	2,4962	4,6617	7,6306	12,4488
40	2,6950	5,2423	8,2193	13,7350
50	3,1286	5,9945	9,4402	15,8717
60			11,5350	18,2343
70				20,0833
80				21,5323



YSB MATKAP UÇLU VİDALAR (DIN 7504-N)

	13	16	19	22	25	32	38	45	50	60	70	80	100
3.9	0,3142	0,3561	0,3872	0,4201	0,4606	0,5669	0,6505						
4.2	0,4047	0,4594	0,4809	0,5404	0,5804	0,7005	0,8080	0,9206	1,0200				
4.8	0,5145	0,5610	0,6239	0,6774	0,7565	0,8730	1,0055	1,1218	1,2478	1,4475	1,6478	2,0555	2,5265

**YHB MATKAP UÇLU VİDALAR (DIN 7504-P)**

	13	16	19	22	25	32	38	45	50	60	70	80	100
3.9	0,2500	0,2840	0,3120	0,3585	0,3964	0,4974	0,5783						
4.2	0,2878	0,3700	0,4065	0,4600	0,5215	0,5900	0,7005	0,7915	0,8825	1,0448			
4.8		0,4755	0,5305	0,5750	0,6380	0,7994	0,9142	1,0705	1,1562	1,3859	1,5938	1,9140	2,3560

SUNTA VİDALARI (DIN 7505)

	13	16	20	25	30	35	40	45	50	60	70	80	100	120
3.5	0,1750	0,2243	0,2200	0,2654	0,2700	0,3164	0,3480	0,3902	0,4218					
4		0,2527	0,2678	0,3030	0,3528	0,4004	0,4480	0,4922	0,5332	0,6645	0,7384			
5				0,4745	0,5702	0,6150	0,6965	0,7740	0,8250	0,9778	1,1200	1,4180	1,8690	
6									1,2946	1,5000	1,7160	1,8835	2,5082	3,0340

SUNTA VİDALARI (DIN 7505) 10'LU PAKET

	13	16	20	30	40	50	60	70	80	100	120
3.5	5,40	6,60	6,10	8,50	9,15	10,50					
4			8,10	10,50	13,50	15,90	19,80	22,20			
5				17,10	23,10	9,90	29,40	33,60	42,60	56,10	
6						38,70	45,00	51,60	56,40	75,30	90,90

**İSPANYOLET VİDALARI
YHB Seyrek Dişli (DIN 7982)**

3.9x25	0,3931
3.9x38	0,5676

**ÇATI TRAPEZ VİDALARI (DIN 7504-K)**

	19	25	32	38	50	60
4.8	1,3051	1,4549	1,5330			
5.5		1,6000	1,8749	2,0335	2,3818	2,6668
6.3		2,3131	2,7144	2,9178	3,4879	3,9165

BETON TRAPEZ VİDALARI

6.3x50	6.3x60	6.3x75	6.3x90	6.3x105	6.3x125
2,1439	2,6200	2,8580	3,1200	3,840	4,4550

**BULDEX VİDALAR (BEYAZ)**

7.5x60	7.5x80	7.5x100	7.5x120	7.5x150	7.5x200
1,6490	2,0619	2,5650	3,1410	4,1500	7,7280

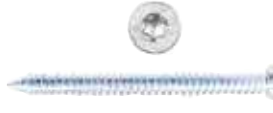
**POLİÜRETAN PANEL VİDALARI
6 mm DELME KAPASİTELİ**

5.5x66	5.5x75	5.5x90	5.5x105	5.5x120
3,1300	3,4400	3,9120	4,3700	4,8700

**SİVRİ UÇLU
ALÇIPAN VİDA**

	25	35	45
3.5	0,3340	0,4280	0,5600

**MATKAP UÇLU
ALÇIPAN VİDA**

	25	35
3.5	0,4390	0,5500

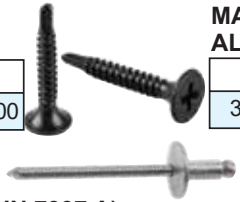
**RYSB
Matkap Uçlu Saç Vıdası**

3.9x13	0,3961
3.9x16	0,4425
3.9x19	0,4780
3.9x25	0,5736

**ALÜMİNYUM POP PERÇİNLER (DIN 7337 A)**

	6	8	10	12	15	18	20	25
3	0,4644	0,4846	0,5048	0,5452	0,5856			
4	0,4644	0,4846	0,5048	0,5452	0,5856	0,6260	0,6664	0,7067
5		0,6865	0,7269	0,7673	0,8077	0,8683	0,9087	1,0096

**MATKAP UÇLU
DİKİŞ VİDASI**

4.8x20	1,4480
--------	--------

**İNCE DÜZ RONDELA (DIN 125) TL/KG**

1/8	5/32	3/16	1/4	5/16	3/8	7/16	1/2
107,25	96,52	96,52	96,52	92,95	92,95	92,95	92,95

DÜZ RONDELA 2 MM (DIN 125) TL/KG

5/16	1/4	3/8
92,50	92,50	92,50

**ŞASE PULLARI**

1/4	86,66 TL/Kg
5/16	86,66 TL/Kg
3/8	86,66 TL/Kg
1/2	86,66 TL/Kg
5/8	86,66 TL/Kg

KALIN DÜZ RONDELA (DIN 125) TL/KG

5/16	3/8	7/16	1/2	9/16	5/8	3/4	7/8	1	1 1/4
88,66	88,66	88,66	88,66	88,66	88,66	88,66	88,66	88,66	88,66

**METRİK DÜZ RONDELA (DIN 125)**

M3	M4	M5	M6	M8	M10
0,0801	0,1301	0,1327	0,1561	0,2382	0,4576

METRİK DÜZ RONDELA (DIN 125) TL/KG

M12	M14	M16	M18	M20	M22	M24	M27	M30
88,66	88,66	88,66	88,66	88,66	88,66	88,66	88,66	88,66

YAYLI RONDELA (DIN 127) 2. Kalite

1/8	5/32	3/16	1/4	5/16	3/8	7/16	1/2	9/16	5/8	3/4	7/8	1	1 1/8	1 1/4
0,060	0,070	0,110	0,160	0,235	0,340	0,455	0,650	0,740	0,870	1,625	1,95	2,50	6,50	6,85

YAYLI RONDELA (DIN 127) 1. Kalite

M5	M6	M8	M10	M12	M14	M16	M18	M20	M22	M24	M27	M30
0,260	0,295	0,507	0,820	1,22	1,75	2,60	3,15	4,28	5,45	7,85	8,80	14,50

**TIRTİL RONDELA (DIN 6798/A)**

M3	M4	M5	M6	M8	M10	M12	M14	M16
0,1320	0,1430	0,1650	0,2200	0,4290	0,7040	1,1220	1,6720	2,1450



İTHAL YSB MATKAP UÇLU VİDALAR (DIN 7504-N)

	13	16	19							60	70	80	
3.9	0,2149	0,2410	0,2656										
4.2													
4.8										1,000	1,1385	1,4055	

**İTHAL YHB MATKAP UÇLU VİDALAR (DIN 7504-P)**

	13	16	19	22	25	32	38	45	50	60	70	80	100
3.9	0,1715	0,1955	0,2147	0,2439	0,2996	0,3383	0,3933						
4.2								0,5471	0,6231				
4.8					0,4340	0,5438	0,6219		0,7865	0,9428	1,0842	1,300	

İTHAL SUNTA VİDALARI (DIN 7505)

	13	16	18	20	25	30	45	50	60	70	80	100	120
3.5	0,1158	0,1483		0,1446	0,1745	0,1871		0,2923					
4				0,1811		0,2383	0,3332		0,4500				
5									0,6840	0,7838	1,0277		

**İTHAL ÇATI TRAPEZ VİDALARI (DIN 7504-K)**

	19	25	32	38	50	60
5.5		1,000	1,2842	1,3928	1,6314	1,8266

**İTHAL RYSB****Matkap Uçlu Saç Vidası**

3.9x13	0.2713
3.9x16	0.3031
3.9x19	0.3274
3.9x25	0.3929

**İTHAL MATKAP UÇLU ALÇIPAN VİDA**

	25	35
3.5	0,2705	0,3402



DEMİR VE ÇELİKLERİ ODA SICAKLIĞINDA SİYAHLAŞTIRMA İÇİN MODERN ÇÖZÜM



BLACKFAST CHEMICALS

BLACKFAST 626	4.91 \$/Kg
BLACKFAST 716	5.05 \$/Lt
BLACKFAST 551	3.94 \$/Lt
BLACKFAST 513	3.64 \$/Lt
BLACKFAST 181	10.60 \$/Lt
BLACKFAST 182	15.45 \$/Lt
BLACKFAST 183	10.33 \$/Lt
BLACKFAST 800	11.90 \$/Lt
BLACKFAST 833	8.25 \$/Lt
BLACKFAST 841	6.85 \$/Lt
BLACKFAST 933	12.95 \$/Lt
Isıtıcı Levha (Küçük)	3.20 \$
Isıtıcı Levha (Büyük)	4.98 \$

UYGULAMA ALANLARI

Kesici Takımlar - El Aletleri - Takım tutucular
Somunlar - Dişliler - Makine parçaları - Ölçü Aletleri
Hidrolik valfler - Matkap Uçları - Civatalar
Oto Parçaları - Yayarlar - Vidalar - Silahlar

AVANTAJLARI

Siyahlaştırma sonrası parçalarda ölçü değişikliği olmaz. Dökme demir ve dökme çeliklerde de uygulanabilir.

Siyah oksit, Yüzeyleri paslanmaya karşı korur.

Kaliteli siyah yüzey ile parçalar, diğerlerinden daha kolay satılır hale gelir.

Siyah Yüzeyler, çalışan aletlerdeki ışık yansımalarını düşürerek operatör güvenliğine katkıda bulunur.

Sistem için ısıtma gerekmediği gibi kimyasallar kullanılmadıkça özelliklerini de kaybetmez.

Kimyasallar malzeme üzerine kolayca uygulanabilir. Çalışan personel için fazlaca teknik bilgi gerekmez. Blackfast kimyasalları çevre dostudur.

GENEL DAĞITIM

ÖZİPEKLİLER

TEKNİK HIRDAVAT - ÇELİK TİC. VE SAN. A.Ş.

Yeni Yalova Yolu No: 332 K.Balıklı 16250 - BURSA
Tel: 0 224 215 15 15 Fax : 0 224 215 15 20



ÖZİPEKLİLER

TEKNİK HIRDAVAT - ÇELİK TİCARET VE SAN. A.Ş.

11.03.2022



Duracell Alkalin MN21 A23 12V Kalem Pil
AAA Kalem Pil 65.00 TL/Adet
Tekli Paket

Duracell Alkalin MN27 A27 Kalem Pil
AAA Kalem Pil 135.00 TL/Paket
Tekli Paket



Duracell Alkalin İnce Pil
AAA İnce Pil 87.00 TL/Paket
2'li Paket

Duracell Alkalin İnce Pil
AAA İnce Pil 150.00 TL/Paket
4'lü Paket



Duracell Alkalin Kalem Pil
AA Kalem Pil 87.00 TL/Paket
2'li Paket

Duracell Alkalin Kalem Pil
AA Kalem Pil 150.00 TL/Paket
4'lü Paket



Duracell Alkalin 9V Pil
Tekli 230.00 TL/Paket

Duracell Özel Pil
CR2016 3V Lityum Pil 125.00 TL/Paket
2'li Paket

CR2016 3V Lityum Pil 300.00 TL/Paket
5'li Paket

CR2032 3V Lityum Pil 125.00 TL/Paket
2'li Paket

CR2032 3V Lityum Pil 300.00 TL/Paket
5'li Paket

CR2025 3V Lityum Pil 125.00 TL/Paket
2'li Paket

CR123A 12V Lityum Pil 288.00 TL/Paket
2'li Paket



Duracell Şarjlı Pil
750 mAh 345.00 TL/Paket
1300 mAh 368.00 TL/Paket
2500 mAh 620.00 TL/Paket
2'li Paket



Toshiba Alkalin Kalem Pil LR6
4'lü paket 56.00 TL/Paket

Toshiba Alkalin İnce Kalem Pil LR3
4'lü paket 56.00 TL/Paket

Kalem Pil
1.5 Volt Kalem Pil 20.00 TL/Paket
4'lü Ambalaj

1.5 Volt İnce Kalem Pil 20.00 TL/Paket
4'lü Ambalaj

1.5 Volt Orta Pil 35.00 TL/Paket
2'li Ambalaj

9 Volt Pil 25.00 TL/Paket
Tekli Ambalaj



Kumpas Pili
AG13, LR 44, 357 14.00 TL/Adet

Elektronik Pil
Varta CR 20/32 N, 3volt, 170mAh,
11.6x10.8 mm, lityum 17.00 TL/Adet



PT - 5910
Pilli Kafa Lambası
odaklanabilir ışık 130.- TL

PT - 7688
Pilli Kafa Lambası 80.- TL



PT - 5018
Kafa Lambası 70.- TL

PT - 5208
Şarjlı Kafa Lambası 130.- TL



PT 7278
El Feneri 48.00 TL

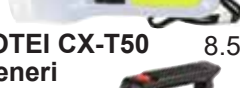

MOOTEI CX-T50
El Feneri 8.50 TL



PT 8407
USB Şarjlı El Feneri 260.00 TL



PT 8817
USB Şarjlı Spot Fener 900.00 TL



GD 425
Projectör Şarjlı El Feneri 27.00 \$

PT 7695
Şarjlı El Feneri 10.00 \$



PT 6106
USB Şarjlı El Feneri 217.00 TL

PT 6104
USB Şarjlı El Feneri 288.00 TL

PT 6105
USB Şarjlı El Feneri 240.00 TL

PT 6003
Bisiklet Feneri 127.00 TL



PT 6001
Bisiklet Feneri 163.00 TL

PT-6909
Mıknatıslı El Feneri 155.- TL



PT 602 B
Cep Feneri 40.00 TL

PT 909 A
Cep Feneri 40.00 TL

GYQ-Q75
El Feneri 46.- \$



AVEC AV-W101B
Micro USB Şarj Kablosu 42.00 TL

AVEC AV-W132B
Type C Şarj Kablosu 60.00 TL

AVEC AV-W106B
Lightning Şarj Kablosu 60.00 TL





Masa Tip Hesap Makinası 245.- TL
12 hane, hafızalı,
15x16x1 cm



Çanta Tip Hesap Makinası 188.- TL
12 hane, hafızalı,
10x15x1 cm



Metal Delgeç 91.- TL
Orta Boy, 2mm
20 sayfa kapasiteli



Stick Yapıştırıcılar

Noki stick yapıştırıcı, silinebilir,
kokusuz

13410 - 10 gr	12.50 TL
3420 - 20 gr	19.75 TL
3440 - 40 gr	36.00 TL



Şeffaf Kırtasiye Bant

Orta Boy - 12mmx33mt 15.00 TL
Büyük Boy - 12mmx66mt 35.00 TL



Bant Kesme Makinası

Orta Boy 86.- TL
12 mm x 33 mt, dar göbekli bant

Bant Kesme Makinası

Büyük Boy 185.- TL
12 mm x 66 mt, dar ve geniş
göbekli bant



Kağıt Makası 45.00 TL
7", 200mm, plastik saplı
26330



Ambalaj- Para Lastiği

1 kg 118.- TL/Pk



RBL-50 Ambalaj - Para Lastiği
50 gr 24.- TL



No:10 Mini Zimba Makinası 85.00 TL



No:24/6 Lüks Zimba Makinası 152.00 TL



Rtz 10

Zimba Makinası Teli
RZT-10, No: 10 Mini 7.60 TL/Pk
1000 Adet/Paket



Rtz 24

Zimba Makinası Teli
RZT-24/6, No: 24/6 9.- TL/Pk
500 Adet/Paket



231 Tel Sökücü 30.00 TL



Ataç
No:3, Metal, 50 mm 13.- TL/Pk
100 Adet/Paket



Toplu İğne
No: 28, 20 gr 13.- TL



7202 Şerit Silici Daksil 28.- TL/Pk
5 mm x 8 mt, şeffaf, yatay



Maket Bıçağı 26412 0.33 \$
18mm, Plastik gövde



Maket Bıçağı 26354 1.44 \$
18mm, Metal kızaklı



Maket Bıçağı
9mm, Metal kızaklı



Maket Bıçağı 1.40 \$
9mm, Metal gövde



Maket Bıçağı 77456 1.44 \$
18mm, Metal gövde



Alüminyum Maket Bıçağı Pro
18mm 1.55 \$

Yedek Maket Bıçak (Backup Utility Knife)

9 mm	0.75 \$/Paket
18 mm	0.87 \$/Paket
SDI Yedek 18 mm	90.00 TL/Paket
SDI Yedek 9 mm	57.00 TL/Paket
10 Adet/Paket	



Yedek Bıçak, Üçgen Tip 1.45 \$
1 paket - 10 adet



Yedek Bıçak, Çengelli Tip 2.80 \$
1 paket - 5 adet



MB 52201 Maket Bıçağı 78037 5.20 \$
Baklava tip, alüminyum gövde



Maket Bıçak 2.40 \$
Baklava tip plastik 1781



Kitlenebilir Halı Kesme 5.65 \$



Parmak Maket Bıçak 3.76 \$

**Eltos Marangoz Kalem**

Siyah EMK004 31.00 TL
Kırmızı EMK005 31.00 TL

**Tükenmez Kalem**

Kırmızı 8.00 TL
Mavi 8.00 TL
Siyah 8.00 TL



4207 Kurşun Kalem 12.00 TL
 Mercanlı, HB



Kırmızı Kalem 14.00 TL



Ediing 750 215.00 TL

Tam Örtücü Boya Kalem

Metal gövde, yuvarlak uç, 2-4 mm

Ediing 780 365.00 TL

Tam Örtücü Boya Kalem

Metal gövde, yuvarlak uç, 0,8 mm



Ediing 751 215.00 TL

Tam Örtücü Boya Kalem

Metal gövde, yuvarlak uç, 1-2 mm



Ediing 300 55.00 TL

Cam Yazı Kalem

Plastik gövde, yuvarlak uç, 1,5-3 mm
 Metal cam ve plastik gibi birçok yüzeyler üzerinde kalıcı olması istenilen yazım, işaretleme ve çizim için idealdir.
 Markörleri doldurabilir.



Ediing 142 M

Asetat Kalem

Parmanent mürekkep, yuvarlak uç, 1 mm

Mavi 80.00 TL

Siyah 80.00 TL

Ediing 149 M 80.00 TL

Asetat Kalem Siyah

Parmanent mürekkep, yuvarlak uç, 1 mm

Ediing 147 S 80.00 TL

Asetat Kalem

Parmanent mürekkep, yuvarlak uç, 0,3 mm
 Özellikle tepzegözlerde kullanılan, asetat filmleri için geliştirilmiş asetat kalemleri, karton, metal, plastik, cam gibi hemen tüm yüzeylerde kalıcı işlem yapmak için idealdir.
 Mürekkepleri projeksiyonda zengin renk verir.

Ediing 140 S

Mavi 80.00 TL

Siyah 80.00 TL

**Koli Yazma Kalem**

Kraft Permanent Markör
 5mm, yağlı mürekkep
Mavii 9.00 TL
Kırmızı 9.00 TL
Siyah 9.00 TL



Artline 55.00 TL

Ahşap Tamir Kalem

Ceviz, Meşe, Kiraz, Çam, Koyu meşe
 Kaplama ve masif ağaç gibi ahşap yüzeylerde oluşan çizikleri ve darbe almış alanları tam örterek boyar. 13 renk alternatifi ile iyi rötuş sağlar.



Artline
Fayans Derz Kalem 3.40 \$

**Beyaz Tahta Kalem**

Kırmızı 18.00 TL
Mavi 18.00 TL
Siyah 18.00 TL

Beyaz Tahta Silgisi 25.00 TL



Fosforlu Kalem 17.00 TL
 Keçeli tip, yatay ve kesik uç

Fosforlu Kalem Set 90.00 TL
 Keçeli tip, 5'li set



Tebeşir
 Beyaz 15'li Paket 15.00 TL/Pk



Renkli Tebeşir
 15'li Paket 30.00 TL/Pk



Sıcağa Dayanıklı Yağlı Tebeşir
 Beyaz 12'li Paket 50.00 TL/Pk



Mantar Pano 250.00 TL
 RMP-12

60x90 cm, ahşap çerçeveli, harita çivili, çift taraf kullanım

Raptiye (Harita Çivisi)
 19'li Paket 12.50 TL/Pk



Noki Telli Dosya 7.00 TL
 A4 formatında

Poşet Dosya (Eko) 38.- TL/Pk
 A4 formatında, delikli, şeffaf
 1000 Adet/paket



180° Klasör Geniş Tip 45.00 TL
 80 mm çakma mekanizmalı,
 540 sayfa kapasitelidir.

180° Klasör Dar Tip 45.00 TL
 50 mm çakma mekanizmalı,
 330 sayfa kapasitelidir.



Telgraf Karton Kalsör
 Büyük Boy, 2 Halka 55.00 TL
 Küçük Boy, 2 Halka 55.00 TL
 Büyük Boy, 4 Halka 245.00 TL



Alpaka Türk Bayrağı
 20x30 cm 30.00 TL
 30x45 cm 55.00 TL
 40x60 cm 75.00 TL
 50x75 cm 140.00 TL
 60x90 cm 180.00 TL
 70x125 cm 230.00 TL
 80x120 cm 270.00 TL
 100x150 cm 400.00 TL
 120x180 cm 570.00 TL
 200x300 cm 1350.00 TL



A4 Fotokopi Kağıdı
 80 gr 155.00 TL



Bahçe Süpürgesi
40 cm, sert ekonomik, plastik
26162 107.00 TL

Bahçe Süpürgesi
60 cm, sert ekonomik, plastik
00113 187.00 TL



Oto Fırça Battal 26156 62.00 TL
Oto Fırça Luna 98.00 TL



Bahçe Çalı Fırçası
40 cm, ahşap gövde, plastik aparatlı
26160 127.00 TL



Yer Fırçası Sert 26157 50.00 TL
Yer Fırçası Tüylü 01305 50.00 TL



Jumbo Yer Fırçası (Tüylü)
40 cm 20566 115.00 TL

Jumbo Yer Fırçası (Sert)
40 cm 20559 100.00 TL



Endüstriyel Yer Fırçası
100 cm, Ahşap gövde, kıl
fırça 01480 462.00 TL



Yedek Sap
Metal 20 mm 26159 50.00 TL



Teleskopik Sırık
2 mt 26152 159.00 TL
3 mt 26154 200.00 TL
4 mt 26155 240.00 TL

Fırça Sapı Takma Aparatı
Plastik 10.00 TL



Çamaşır Suyu
2.5 Kg 35.00 TL
5 Kg 130.00 TL
30 Kg 645.00 TL

Çamaşır Suyu Kıvamlı
5 Kg 180.00 TL
30 Kg 1050.00 TL



WC Banyo Temizleyici
2.5 Kg 80.00 TL
5 Kg 165.00 TL
30 Kg 750.00 TL



Tuz Ruhü
2.5 Kg 50.00 TL
5 Kg 200.00 TL
30 Kg 440.00 TL



Cam Kazıma Aparatı 30.00 TL



Cam Kazıma Jileti 7.00 TL/Adet



Yer Kazıma Aparatı 65.00 TL



Yer Kazıma Jileti 10.00 TL/Adet



Tampıcı Fırın Fırçası
40 cm 259.00 TL
50 cm 340.00 TL
60 cm 385.00 TL



Yedek Sap Defne, Gürgen Vidalı
1.20 m 50.00 TL
1.50 m 65.00 TL
2.00 m 105.00 TL
1.20 m sivri uç 55.00 TL



Camsil
0.5 Kg 40.00 TL
5 Litre 200.00 TL

Aspirix
Çok Amaçlı Temizleyici 68.00 TL
750 ml



Sıvı Bulaşık Deterjanı
5 Kg 165.00 TL
20 Kg 630.00 TL
30 Kg 850.00 TL



Sıvı El Sabunu 35.00 TL
400 ml



Sıvı El Sabunu Pembe
5 Kg 165.00 TL
20 Kg 505.00 TL
30 Kg 750.00 TL

Sıvı Köpük Sabun
5 Kg 240.00 TL
20 Kg 850.00 TL
30 Kg 875.00 TL



Yüzey Temizleyici
5 Lt 130.00 TL
30 Lt 620.00 TL

Yüzey Temizleyici Sabun Kokulu
5 Lt 290.00 TL
20 Lt 1050.00 TL
30 Lt 1475.00 TL

Ahşap Yüzey Temizleyici
750 gr 65.00 TL



Arap Sabunu
1000 gr sıvı 55.00 TL
15 kg fiç 1000.00 TL



Plastik Nemli Mop Tutucu (Sapsız)
50x13 25860 120.00 TL



Tel Mop Tutucu (Sapsız)
40 cm 25862 98.00 TL
50 cm 25863 104.00 TL
60 cm 25864 104.00 TL
80 cm 25865 125.00 TL



İp Nemli Mop
40 cm 25870 34.90 TL
50 cm 25871 37.50 TL
60 cm 25872 37.50 TL
80 cm 25873 47.50 TL



Mikrofiber Nemli Mop
40 cm 61.00 TL
50 cm 25891 66.00 TL
60 cm 25892 66.00 TL
80 cm 25893 92.00 TL



Islak Mob
Küçük Extra 06317 46.00 TL
Büyük Extra 06300 54.00 TL



Endüstriyel İp Mop
Medium 87.00 TL

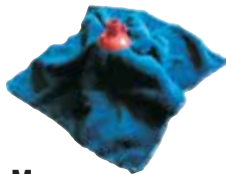

Havlü Mop 36.00 TL



Maşrafa 17.50 TL
Faraş Lüks El Tipi 17.50 TL



Paspas Arabası 1250.00 TL
Çift Kovalı Paspas Arabası 610.00 TL
Yedek Pres Paspas Arabası 250.00 TL
Yedek Kova Paspas Arabası 3 200.00 TL
Çift Kovalı Araba Tekerleri 85.00 TL



Vileda Kovası
Vileda Kova 79.00 TL
Vileda Püskül İpli 67.00 TL
Vileda Püskül Kumaş 55.00 TL



Spin Mop 400.00 TL
Döner Başlıklı Set 19 Lt
Spin Mop yedek aparatı 50.00 TL
Spin Mop yedek mop 55.00 TL
Spin Döner sap + püskül + palet 200.00 TL



Spin Mop Tablet 645.00 TL
Spin Mop Tablet Yedek 65.00 TL



Islak Mop Aparatı Plastik
Geniş 76.00 TL
Dar 66.00 TL



Islak Mop Aparatı Metal
Geniş 114.00 TL
Dar 106.00 TL

Metal Yaylı Sap 150.00 TL
25811



Alüminyum Düz Boru 70.00 TL
25815



Yersil 40 cm 25841 54.00 TL
Yersil 60 cm 25843 60.00 TL



Yersil Metal
55 cm 25845 169.00 TL
75 cm 205.00 TL



Camsil Küçük 25852 30.00 TL
Camsil Büyük 25851 40.00 TL
Camsil Süngerli 69.00 TL



Camsil Metal
25 cm 232.00 TL
35 cm 272.00 TL
45 cm 282.00 TL

Camsil Lastiği 105 cm 100.00 TL



WC Fırça Takımı 42.00 TL
WC Matik 18.00 TL



UR 3016 Vantuz Pompa Körüklü 30.00 TL
Vantuz Pompa Körüklü Büyük 40.00 TL



YF 206 Fırça Süpürge 55.00 TL



Çöpçü Faraşı 265.00 TL
Çöpçü Fırçası (saplı) 182.00 TL
Fırçalı Faraş Saplı 120.00 TL
Fırçalı Faraş Saplı Hazneli 130.00 TL



Antik Saksı

No:0 - 14x12 cm	12.50 TL
No: 1 - 17x14.5 cm	18.50 TL
No:2 - 20.5x17 cm	26.00 TL
No:3 - 24x19.5 cm	36.00 TL
No:4 - 28x24 cm	52.00 TL
No:5 - 32x27.5 cm	72.00 TL
No:6 - 37x32 cm	105.00 TL
No:7 - 43x34.5 cm	140.00 TL



Villa Dış Mekan Saksı

V511 - 530x410 mm - 45 Lt	242.00 TL
V512 - 530x410 mm - 54 Lt	315.00 TL
V513 - 640x460 mm - 76 Lt	430.00 TL
V514 - 680x530 mm - 110 Lt	650.00 TL



Ekonomik Fidan Saksı

1.4 Lt	8.25 TL
2 Lt	12.00 TL
2.7 Lt	13.00 TL
3.7 Lt	14.00 TL
4 Lt	



İstanbul Balkon Saksı

İB05 - 755x190x170 mm - 17 Lt	415.00 TL
-------------------------------	-----------



Elvan Sukulent Saksı

ES01	15.00 TL
------	----------



Kalp Aranjman Saksı

KA01 Şeffaf- 210x158x66 - 1.7 Lt	42.00 TL
KA01 Kırmızı- 210x158x66 - 1.7 Lt	42.00 TL



Kayık Aranjman Saksı

KY02 - 205x135x100 mm - 1.2 Lt	28.00 TL
--------------------------------	----------



Poliwork Çilek Makrome Saksı

4'lü	240.00 TL
------	-----------



Bahçe Sulama Bidonu

5 Lt	145.00 TL
10 Lt	165.00 TL



Sulama Kabı

SK03 - 3 Lt	50.00 TL
-------------	----------



Çiçek Sulama Aparatı



12.00 TL



Papatya Saksı

P001 - 115x110 mm -0.7 Lt	31.00 TL
P002 - 143x133 mm -1.5 Lt	44.00 TL
P003 - 180x165 mm -3 Lt	63.00 TL
P004 - 225x260 mm -6 Lt	93.00 TL
P005 - 280x260 mm -12 Lt	145.00 TL
P006 - 351x329 mm -22 Lt	285.00 TL
P007 - 450x420 mm -46 Lt	410.00 TL



Hasır Saksı

HS01 - 209x167 mm -3.3 Lt	77.00 TL
HS02 - 250x200 mm -6 Lt	107.00 TL
HS03 - 305x235 mm -10 Lt	142.00 TL
HS04 - 355x270 mm -15 Lt	209.00 TL
HS05 - 415x310 mm -25 Lt	268.00 TL
HS06 - 500x375 mm -42 Lt	417.00 TL



Damla Duvar Saksı

DD03 - 345x195 mm - 3.4 Lt	54.00 TL
----------------------------	----------

Damla Duvar Saksı

DK01 - 240x195 mm - 1.7 Lt	54.00 TL
----------------------------	----------



Orkide Saksı

ORK0 - 130x135 - 1.2 Lt	39.00 TL
ORK1 - 125x125 - 1.3 Lt	70.00 TL



Villa Balkon Saksı

V610, 320x175x195 - 6 Lt
V620, 520x175x195 - 10 Lt
V630, 720x175x195 - 14 Lt

56.00 TL
81.00 TL
112.00 TL

Balkon Saksı Askısı

plastik, 2'li

29.50 TL

Balkon Saksı Askısı Metal

30 cm
50 cm
70 cm

90.00 TL
102.00 TL
110.00 TL



Nergiz Saksı

N001, 350x242x343 - 9.8 Lt
N001, 476x336x474 - 25.3 Lt
N001, 588x411x589 - 47 Lt

160.00 TL
316.00 TL
650.00 TL



Dış Mekan Hisar Kare Saksı

HK03 - 370x335x370 - 25.5 Lt
HK04 - 442x400x442 - 44 Lt
HK05 - 534x470x534 - 74.3 Lt

240.00 TL
316.00 TL
520.00 TL



Ayaklı Bahçe Saksı (Hobi, sera)

ABS2 - 765x660x375 mm
FNS1 - 765x27x375 mm

640.00 TL
350.00 TL



Bahçe Kulesi Yediveren Sabit Saksı

1900.00 TL

Bahçe Kulesi Yediveren Tekerlekli Saksı

2100.00 TL



Bahçe Kulesi Yonca Sabit Saksı

Bahçe Kulesi Yonca Tekerlekli Saksı



Dış Mekan Saksı

85x34x30 cm - 60 Lt

380.00 TL

Dış Mekan Saksı Altlığı

140.00 TL



Yakut Saksı

YAS6 - 390x390 mm - 33 Lt

565.00 TL



Akıllı Saksı Aparat Takımı

ASAT6

620.00 TL



Elvan Arajman Saksı

EAS2 No : 2 - 2 Litre
EAS3 No : 3 - 4.8 Litre

72.00 TL
116.00 TL



Yuvarlak Damla Sulama Borusu

1.00 mm

Deliksiz 1600 2065.- TL

16 mm çap - 400 mt

25 cm Delikli 1625 2250.- TL

16 mm çap - 400 mt



Damlama Kurtağı Mini Vana

16x16

370 8.05 TL



Damlama Kurtağı Dış Dişli Mini Vana

16x 1/2"

372 8.05 TL



Naturel Conta

16 mm kanallı 209 2.10 TL



Damlama Kurtağı Ekleme Nipeli

16x16

207 0.85 TL



Damlama Kurtağı TE

16x16x16

205 1.45 TL



Damlama Kurtağı YE

16x16x16

234 3.42 TL



Damlama Kurtağı Kör Tapa

16 mm

210 0.85 TL



Damlama Kurtağı Dirsek

16x16

206 1.25 TL



Klipsli Boru Sabitleme Kazığı

Kısa, 15 cm

233 2.75 TL

Uzun, 25 cm

227 3.85 TL



1/2 PVC Nipeli 402 8.40 TL



1/2 PVC Manşon 362 8.40 TL



Mist Sisleme Takım

5.5 Lt

422

7.5 Lt

423



3 mm Damlama Delme Aparatı

3 mm

211

77.00 TL

16 mm Kangal Delici

Metal

213

93.60 TL



Debi Ayarlı Damlatıcı

Yeşil 100 lt/saat

201

1.56 TL

Debi Ayarlı Damlatıcı

Kırmızı 70 lt/saat

202

1.38 TL



Basınç Ayarlı Hat Üstü Damlatıcı

Kırmızı 4 lt/saat

297

3.25 TL

Sarı 8 lt/saat

298

3.25 TL

Mor 12 lt/saat

299

3.25 TL



Erkek Adaptör

1/2" - 16 mm

365

2.40 TL

3/4" - 16 mm

366

2.40 TL

1/2" - 20 mm

367

2.40 TL

3/4" - 20 mm

368

2.40 TL



Pipo Dirsek

1/2" - 16 mm

216

3.60 TL

3/4" - 16 mm

217

3.60 TL

1/2" - 20 mm

218

3.60 TL

3/4" - 20 mm

219

3.60 TL



PP Kaplin Çıkışlı Küresel Vana

20x20 mm

127.50 TL

25x25 mm

163.00 TL

32x32 mm

213.00 TL



Dıştan Dişli Kaplin Erkek Dirsek

20 mm

12.80 TL

25 mm

26.75 TL



Kaplin Erkek

20x 1/2"

13.85 TL

25x 1/2"

18.49 TL

32x 1"

19.15 TL



Kaplin Dişi

20x 1/2"

13.85 TL

25x 1/2"

18.45 TL

32x 1"

19.15 TL



Kaplin Manşon

20x20

17.29 TL

25x25

24.10 TL

32x32

29.75 TL



Kaplin Dirsek

20x20

27.45 TL

25x25

35.50 TL

32x32

37.35 TL

Kaplin Dişi Dirsek

20x 1/2"

12.80 TL



Kaplin TE

20x20

41.05 TL

25x25

50.75 TL

32x32

70.35 TL



Kaplin Tapa

20

13.50 TL

25

17.35 TL

32

23.70 TL



Sulama Tabancası
8 fonksiyonlu MK1484 4.30 \$
3 parça

Sulama Tabancası
8 fonksiyonlu MK1486 5.10 \$
5 parça



Sulama Tabancası
2 fonksiyonlu MK1480 3.50 \$
3 parça



Sulama Tabancası
2 fonksiyonlu MK1482 4.40 \$
5 parça



Sulama Tabancası Seti 1/2"
4 parça MK1498 2.00 \$



Metal Uçlu Sulama Tabancası
MK1487 3.90 \$



Bahçe Sulama Hortum Seti
15 mt - 8 fonksiyonlu 963 29.50 \$



Çatçatlı Fiskiye
Plastik MK1500 2.86 \$
Alüminyum MK1502 12.50 \$



Hortum Adaptör
1/2" MK1490 0.63 \$
3/4" MK1492 0.74 \$



Musluk ve Hortum Adaptör
1/2" - 3/4" MK1494 0.49 \$

Hortum Bağlantı Parçası
1/2" MK1496 0.53 \$



Sulama ve Yıkama Tabancası
Ayarlanabilir deterjanlı basınçlı püskürtme MK1489 7.80 \$



Sulama Tabancası Çelik
MK1488 7.70 \$



Sihir Hortumlu Sulama Tabanca Seti
15 mt uzatma kapasite MK1489-4 18.00 \$



Çim Biçme Tırpan Misinası Yuvarlak
3.0 mm x 56 mt MK4710 6.60 \$
3.3 mm x 42 mt MK4711 6.60 \$
3.5 mm x 41 mt MK4712 6.60 \$
4.0 mm x 32 mt MK4713 6.60 \$



Çim Biçme Tırpan Misinası Altıgen
3.0 mm x 56 mt MK4720 6.60 \$
3.3 mm x 42 mt MK4721 6.60 \$
3.5 mm x 41 mt MK4722 6.60 \$
4.0 mm x 32 mt MK4723 6.60 \$



Çim Biçme Tırpan Misinası Kare
3.0 mm x 56 mt MK4730 6.60 \$
3.3 mm x 42 mt MK4731 6.60 \$
3.5 mm x 37 mt MK4732 6.60 \$
4.0 mm x 29 mt MK4733 6.60 \$



Çim Biçme Tırpan Misinası Testere
3.5 mm x 41 mt MK4740 11.30 \$
4.0 mm x 32 mt MK4741 11.30 \$



Çim Biçme Misinası Burgulu
Çift Baskı
3.3 mm x 46 mt MK4750 6.90 \$
3.5 mm x 41 mt MK4751 6.90 \$



Çim Biçme Tırpan Misinası
Çelik Telli
3.3 mm x 26 mt MK4760 9.90 \$



**Çatal Çapa
Saplı
Kafa**

EC002 188.00 TL
EC001 107.00 TL



Fide Dikme Aparatı

Kısa FDA001 39.00 TL
Uzun FDA003 54.00 TL



Bağ Budama Makası

8" - 200 mm EBM008 368.- TL



**Sivri Çapa
Saplı
Kafa**

EC006 207.00 TL
EC005 132.00 TL



Kürek Seti EBS003 295.- TL
Kürek, çapa, tırmık



Bağ Budama Makası

9" - 225 mm EBM009 898.- TL



**Üçgen Çapa
Saplı
Kafa**

EC009 145.00 TL
EC008 104.00 TL



Baltalı Çapa No:2 250.00 TL



**Üzüm Makası
Siyah**

EUM002 230.- TL



**Düz Çapa
Saplı
Kafa**

EC012 129.00 TL
EC011 78.00 TL



Üçgen
çapa



Çim Biçme Makası
26334

150.- TL

Edoni Baltalı Kazma

No: 1 EBK001 310.00 TL
No: 2 EBK002 334.00 TL
No: 3 EBK003 357.00 TL

Çapa Çeşitleri
Üçgen (Büyük)

125.00 TL



Fidan Aşı Bağı
160-190 gr

40.00 TL

Edoni Pamuk Çapası

No: 1 EPC001 201.00 TL
No: 2 EPC002 299.00 TL
No: 3 EPC003 322.00 TL



ay
çapa

Çapa Çeşitleri
Ay

160.00 TL



Aşı Macunu
250 gr

85.- TL

Ağaçta kesilen yerleri veya kırılmaları aşı macunu kullanarak yaranın çabuk kapatılmasını sağlar. Çam reçinesinden elde edilen aşı macunu aşı yapıldıktan sonra aşı yerleri haricinde dalın macunla kapatılması gereklidir. Yaranın hava almamasını sağladığından yara çabuk kabuk bağlar.

Edoni Bağ Çapası Tepeli

Geniş BCT002 322.00 TL



Çift Taraflı Jak Rekoru

1/2"	316	24.00 TL
3/4"	318	21.60 TL



TE Hortum Eki

1/2" - 5/8" - 1/2"	104	13.20 TL
3/4" - 3/4" - 3/4"	105	27.00 TL
1 1/4" - 1 1/4" - 1 1/4"	107	45.60 TL



Düz Hortum Eki

1/2"	113	3.60 TL
5/8"	114	5.40 TL
3/4"	115	7.80 TL
1"	116	12.00 TL
1 1/4"	117	18.00 TL
1 1/2"	118	27.00 TL
2"	119	36.00 TL



1/2-3/4" Jak Rekoru

235 30.00 TL



314 315

Jaklı Stoplu Bağlantı Rekoru

1/2"	314	44.50 TL
3/4"	315	52.80 TL



Ayarlı Hortum Bağlantı

1/2"	156	27.60 TL
3/4"	157	63.60 TL



Ayarlı Hortum Bağlantı

1"	158	96.00 TL
----	-----	----------



Ayarlı Hortum Redüksiyonu

3/4" - 1/2"	151	84.00 TL
-------------	-----	----------



Lüks Hortum Eki

1/2" - 1/2" - 1/2"	159	66.00 TL
3/4" - 1/2" - 3/4"	160	84.00 TL
3/4" - 3/4" - 3/4"	161	84.00 TL



Düz Hortum Redüksiyon

3/4" - 1/2"	165	7.20 TL
3/4" - 5/8"	166	10.80 TL
1 1/2" - 5/8"	167	15.60 TL
1" - 3/4"	168	15.60 TL
1 1/4" - 1"	169	18.00 TL
1 1/2" - 1 1/4"	170	48.00 TL
2" - 1 1/2"	171	60.00 TL

Düz Hortum Redüksiyon

1 1/2" - 1/2" - 5/8"	347	22.50 TL
----------------------	-----	----------



Batarya Jak Rekoru Dişi

100 132.- TL

Batarya Jak Rekoru Erkek

101 132.- TL



Otomatik Kelepçe Lüks Musluk Bağlantı

128 70.00 TL



PVC Küresel Vana

1/2"	285	54.00 TL
3/4"	286	67.00 TL
1"	287	84.00 TL
1 1/4"	288	120.00 TL
1 1/2"	289	144.00 TL
2"	290	222.00 TL



335 300.00 TL

2'li Dağıtıcı

1/2" - 3/4" - 1"



336 360.00 TL

4'lü Dağıtıcı

1/2" - 3/4" - 1"



198 Jaklı Kazık Ayak 21.60 TL

164 Kazık Ayak 19.20 TL



312 AÇI AYARLI SPRINK 336.00 TL

134 Yaprak Sprink 44.50 TL



141 Süper 3 kol Sprink 72.00 TL

142 Turbo 3'lü Sprink 74.00 TL



139 Normal 3'lü Sprink 64.80 TL

144 Uzun nozul 3'lü Sprink 69.60 TL



140 Normal 4'lü Sprink 69.60 TL

Kısa nozul

143 5'li Sprink 93.60 TL



148 Açık Ayarlı Sprink Başlığı 180.00 TL

149 Turuncu Açılı Fiskiye 132.00 TL



313 Açısız Çatçat Fiskiye 90.00 TL



Hortum Arabası

186 1440.- TL
187 Tekerlekli 1740.- TL

Duvar Tipi Hortum Askısı

181 1585.- TL

125 Ayarlı Hortum Lansı

54.- TL



Hortum Askı Aparatı

185 132.00 TL



Sulama Hortum Tamburu

20m, duvara monte edilebilir

11840 105.- \$



305 4 İstasyonlu zaman saati

204.- \$



1/2 Açık Ayarlı Fıskiye 184 4.35 \$

Islatma çapı 5mt, yerli

1/2 Pop Up Fıskiye 300 5.45 \$

Islatma çapı 5mt, rainbird

1/2 Rotor Sprink 301 23.90 \$

Islatma çapı 4-20 mt, rainbird

3/4 Rotor Sprink 302 25.75 \$

Islatma çapı 7-30 mt, rainbird

146 Turbo 3'lü Sprink Sehpası 138.00 TL



147 5'li Sprink Sehpası 168.00 TL



145 Jumbo Açık Fıskiye 312.00 TL



154 Plastik Tarla Sulama Fıskiye 132.00 TL
1", ıslatma çapı 20-32 mt



155 Metal Tarla Sulama Fıskiye 816.00 TL
1", ıslatma çapı 20-32 mt



304 11 solenoid vana 44.85 \$



Cansuyu Musluğu 3/4 Mandallı + anahtar 272 312.00 TL

Cansuyu Musluğu 3/4 musluk + anahtar 271 312.00 TL



Özel Depo Rekoru

3/4"	319	60.00 TL
1"	320	60.00 TL
1 1/4"	321	60.00 TL
1 1/2"	322	60.00 TL
2"	323	60.00 TL
2 1/2"	324	240.00 TL
3"	325	252.00 TL



240 PVC Bidon Musluğu 72.00 TL



Depo Rekoru

1/2"	275	60.00 TL
3/4"	276	60.00 TL
1"	277	66.00 TL
1 1/2"	279	108.00 TL
2"	280	138.00 TL
3"	281	324.00 TL
4"	282	420.00 TL



PVC Hortum Rekoru

1/2 "	241	9.60 TL
3/4 "	242	10.80 TL
1"	243	20.40 TL
1 1/4"	244	24.00 TL
1 1/2"	245	30.00 TL
2"	246	50.50 TL



Galvanizli Hortum Rekoru

1/2 "	251	51.60 TL
3/4 "	252	57.60 TL
1"	253	69.65 TL
1 1/4"	254	74.50 TL
1 1/2"	255	86.00 TL
2"	256	138.00 TL
2 1/2"	257	150.00 TL
3"	258	240.00 TL
4"	259	372.00 TL



Çift Taraflı Depo Rekoru

1/2 "	326	48.00 TL
3/4 "	327	54.00 TL
1"	328	60.00 TL



Budama Desteresi Kılıflı
300 mm MK4534 4.20 \$



Budama Desteresi
300 mm MK4532 3.20 \$



Budama Desteresi Orta Diş
270 mm MES 5276 3.30 \$

Budama Desteresi İnce Diş
270 mm MES 5275 3.70 \$



Budama Desteresi PVC Oval Saplı
330 mm MK4536 5.50 \$



Budama Desteresi Ağaç Saplı
300 mm MK4538 3.00 \$



Budama Desteresi Sap Takmalı
330 mm MK4546 6.00 \$



Budama Desteresi Kartal Sap Takmalı
380 mm MK4547 9.00 \$



Kılıflı Budama Desteresi Kurt Dişli
250 mm MK4500 13.10 \$
300 mm MK4510 15.20 \$



Budama Desteresi Orta Diş
250 mm MK4520 11.50 \$



Katlanır Budama Desteresi
MK4548 4.40 \$



Kırmalı Katlanır Orak
45 cm, MES 149
izole kaymaz sap 4.08 \$



Dal Budama Makası
5 cm MK4560 15.00 \$



Teleskopik Dal Budama Makası
5 cm MK4562 22.50 \$



Teleskopik Süper Dal Budama Makası
5 cm MK4564 26.60 \$



Budama Desteresi İnce Diş
250 mm MK4530 11.00 \$



Budama Desteresi Ağaç Saplı Oval
300 mm MK4540 5.10 \$

Budama Desteresi Ağaç Saplı Oval
300 mm MES 9175 4.38 \$
ince diş



Çim Biçme Makası Teleskopik Süper
MK4553 26.80 \$

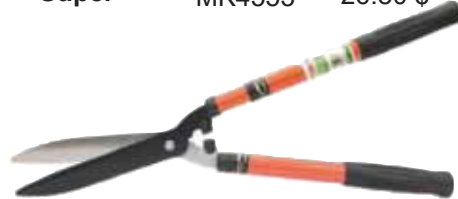

Çim Biçme Makası
MK4550 9.90 \$

Çim Biçme Makası Teleskopik
MK4552 12.60 \$



Çim Biçme Makası Süper
MK4551 13.40 \$



Teleskopik Tepe Makası, 2.80 mt
Metal MK4570 20.00 \$
Alüminyum MK4572 24.70 \$



Kolastar Ağızı, Düz Diş
533 mm MES 5450 1.40 \$
610 mm MES 5451 1.63 \$
762 mm MES 5452 2.00 \$

Kolastar Ağızı, Düz Diş
61 cm MK4705 1.43 \$
76 cm MK4706 1.60 \$



Kolastar Ağızı, Çatal Diş
533 mm MES 5453 1.40 \$
610 mm MES 5454 1.63 \$
762 mm MES 5455 2.00 \$

Kolastar Ağızı, Çatal Diş
61 cm MK4707 1.43 \$
76 cm MK4708 1.60 \$



Kolastar Testere Kolu Ağızlı
MK4702 7.00 \$
61 cm MK4703 7.80 \$
76 cm



Boş Sprey Kutusu 1 Lt 45.00 TL

SM 15002

Mekanik İlaçlama 2 Lt 4.25 \$

SM 16001

Mekanik İlaçlama 16 Lt 840.00 TL



Akülü Sırt Tipi İlaçlama Makinesi

16 Lt, Sırt Tipi 8756 80.40 \$



Motorlu 168.- \$

Yan Tırpan Çim Biçme

26cc, 0.75 kw, 7500 min-1, benzin 25/yağ 1 0.65 lt yakıt tankı, 22 mm çap, 5.6 kg

Motorlu 196.- \$

Sırt Tırpan Çim Biçme

51.7cc, 1.65 kw, 6500 min-1, benzin 25/yağ 1 1.3 lt yakıt tankı, 26 mm çap, 11 kg



Traktör Kompresörü 105.- \$

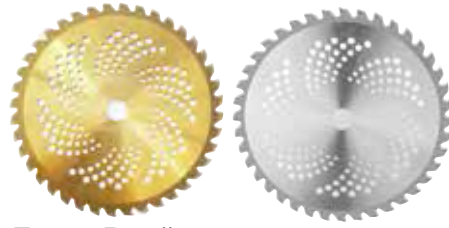

Tırpan Bıçağı

Beyaz
Sarı

6.32 \$
8.00 \$



Bağ Budama Makası

26333

6.20 \$



Bağ Budama Makası T12



**Tırpan Makinasına Zincirli
Testere Aparatı**

11887

46.00 \$



**Tırpan Makinasına
Alüminyum Zincirli Kafa**

11886

11.00 \$



**Tırpan Makinası
Burgulu Tel Fırça**

11885

8.65 \$



**Çim Biçme Tırpan Makinası
Misina Başlık**

11895 6.65 \$
Yeşil



**Çim Biçme Tırpan Makinası
Misina Başlık**

11896 8.65 \$
Kırmızı



Tırpan Makinası için Siperlik

11888

7.70 \$



**TH 370 Çim Biçme Makinası
Misina Başlık**

11897

1.15 \$



517 Şanzımanlı Dizel Çapa Makinesi

17 Hp, 4 zamanlı, 1 silindirli, hava soğutmalı, dizel motor, 122x30 cm çalışma, 32 bıçak, 195 kg

512 Şanzımanlı Dizel Çapa Makinesi

12 Hp, 4 zamanlı, 1 silindirli, hava soğutmalı, dizel motor, 122x30 cm çalışma, 32 bıçak, 195 kg



310 D Şanzımanlı Dizel Çapa Makinesi

7 HP, 4 zamanlı, 1 silindirli, hava soğutmalı, dizel motor, 122x20 cm çalışma, 24 bıçak, 95 kg, bartech motor

300 Şanzımanlı İpli Benzinli Çapa Makinesi

6.5 HP, 4 zamanlı, 1 silindirli, hava soğutmalı, benzinli motor, 92x20 cm çalışma, 24 bıçak, ipli, 3 ileri 1 geri, 85 kg



Benzinli Süt Sağma

Çift sağım, tek güğüm, 6.5 HP, 40 Litre paslanmaz güğüm, 22 Lt vakum tankı, 230-250 Lt/dak, 70lik kuru pompa, 90 kg



Elektrikli Süt Sağma

Çift sağım, çift güğüm, 70lik kuru pompa, 2x30 Lt güğüm, 67.5 kg



Universal Elektrikli Süt Sağma

Çift sağım, çift güğüm, 70lik kuru pompa, 40 Lt alüminyum güğüm, 57 kg



Roket Elektrikli Süt Sağma

Tek sağım, tek güğüm, 70lik kuru pompa, 40 Lt alüminyum güğüm, 58.5 kg



Universal Koyun Sağma

Dörtlü sağım, tek güğüm, 70lik kuru pompa, 40 Lt paslanmaz güğüm, 54 kg



Alüminyum Süt Güğümü

40 Litre
30 Litre
20 Litre

Paslanmaz Süt Güğümü

40 Litre
30 Litre
20 Litre



Ceviz Soyma Makinesi

170 Litre, 250-300 kg/saat, 1.10 kw, 220 volt, 92x85 cm, 106 kg



Yem Kırma Makinesi

6.5 HP, benzinli, 4 zamanlı, 40x60 cm yem haznesi, 5.5 cm mısır koçan çıkış ağız, 78 kg, 500-700 kg/saat buğday, 400-600 kg/saat mısır kırma kapasitesi

Ot Sap Parçalama Makinesi

4 HP, 220 volt, elektrikli, 36.5x34 cm yem giriş, 16.5x64 cm yem çıkış ölçüsü, 75 kg



Aymen Torf Toprak

3 Lt	20.00 TL
5 Lt	40.00 TL
10 Lt	72.00 TL
20 Lt	119.00 TL
40 Lt	245.00 TL

Greenmore Çiçek Toprağı

3 Lt	9.00 TL
5 Lt	12.00 TL
10 Lt	20.00 TL
20 Lt	31.00 TL
40 Lt	89.00 TL



Tropikal Bitki Besini

Yeşil Bitkiler

225 ml	12.00 TL
500 ml	24.00 TL

Tropikal Bitki Besini

Kaktus Sukulent

225 ml	12.00 TL
500 ml	24.00 TL

Tropikal Bitki Besini

Menekşe

225 ml	12.00 TL
500 ml	24.00 TL

Tropikal Bitki Besini

Orkide

225 ml	12.00 TL
500 ml	24.00 TL



Tropikal Yaprak Temizleyici

250 ml	16.00 TL
500 ml	24.00 TL

Tropikal Yaprak Parlatici

250 ml	55.00 TL
500 ml	96.00 TL



Orkide Toprağı

3 Lt	21.00 TL
------	----------



Perlit

10 lt	31.00 TL
-------	----------

Etidot 67 Gübre

1 Kg	175.00 TL
20 Kg	1815.00 TL



Çim Gübresi

25 Kg	1650.00 TL
-------	------------



Çim Tohumu

1 Kg	825.00 TL
10 Kg	6750.00 TL



Kil Bilyesi

0-3 mm - 3 lt	31.00 TL
3-8 mm - 3 lt	31.00 TL
8-15 mm - 3 lt	31.00 TL



Mine Çiçeği Tohumu

27.00 TL

Kazanya Çiçeği Tohumu

27.00 TL

Kedi Tırnağı İpek Tohumu

27.00 TL

Kosmoz Çiçeği Tohumu

27.00 TL

Küstüm Çiçeği Tohumu

27.00 TL

Katmerli Zinnia Çiçeği Tohumu

27.00 TL

Gazanya Çiçeği Tohumu

27.00 TL

Aslanağızı Çiçeği Tohumu

27.00 TL

Portakal Kadife Çiçeği Tohumu

27.00 TL

Aynı Sefa Çiçeği Tohumu

27.00 TL

Kına Çiçeği Tohumu

27.00 TL

Mavi Papatya Çiçeği Tohumu

27.00 TL

Bodrum Papatya Çiçeği Tohumu

27.00 TL

Çilek Çiçeği Tohumu

27.00 TL

Unutma Beni Çiçeği Tohumu

27.00 TL

Çarkıfelek Çiçeği Tohumu

27.00 TL

Kır Papatya Tohumu

27.00 TL

Yeşil Soğan Tohumu

27.00 TL

Kuzu Kulağı Tohumu

27.00 TL

Enginar Tohumu

27.00 TL

Nergiz Tohumu

27.00 TL

Cinya Çiçeği Tohumu

27.00 TL

Kedi Tırnağı (Buz Çiçeği) Tohumu

27.00 TL

Kedi Oto Tohumu

27.00 TL

Mix Papatya Tohumu

27.00 TL

Karagöz Kadife Tohumu

27.00 TL

Zahter Kekik Tohumu

27.00 TL

Süs Kabak Tohumu

27.00 TL

Lavanta Tohumu

27.00 TL

Adaçayı Tohumu

27.00 TL

Kuşkonmaz Tohumu

27.00 TL

Bezelye Tohumu

17.50 TL

Roka Tohumu

17.50 TL

Pırasa Tohumu

17.50 TL

Reyhan (Mor Fesleğen) Tohumu

17.50 TL

Brüksel Lahanası Tohumu

17.50 TL

Kırmızı Lahana Tohumu

17.50 TL

Karadere Lahana Tohumu

17.50 TL

Çilek Tohumu

17.50 TL

Bamya Tohumu

17.50 TL

Çengelköy Hıyar Tohumu

17.50 TL

Ispanak Tohumu

17.50 TL

Brokoli Tohumu

17.50 TL

Karnabahar Tohumu

17.50 TL

Maydanoz Tohumu

17.50 TL

Semizotu Tohumu

17.50 TL

Kıvırcık Marul Tohumu

17.50 TL

Tere Tohumu

17.50 TL

Çeri Domates Tohumu

17.50 TL

Balkabağı Tohumu

17.50 TL

Yalova Sarmalık Lahana

17.50 TL

Yalova Çarliston Biber

17.50 TL

İceberg Marul

17.50 TL

Pepmbe Domates

17.50 TL

Köy Tipi Domates

17.50 TL

Çarliston Tohumu

17.50 TL

Kırmızı Pancar

17.50 TL

Kornişon Hıyar

17.50 TL

Acur Tohumu

17.50 TL

Siyah Kabak

17.50 TL

Çin Turbu

17.50 TL

Dereotu Havuç Tohumu

17.50 TL

Yedikule Marul Tohumu

17.50 TL

Kapya Biber Tohumu

17.50 TL

Çetinel Biber Tohumu

17.50 TL

Sera Demre Biber Tohumu

17.50 TL

Toros Yukarı Bakan Biber

17.50 TL

Yalova Tatlı Biber Tohumu

17.50 TL

Fındık Turp Tohumu

17.50 TL

Alya Patlıcan Tohumu

17.50 TL

Kemer Patlıcan Tohumu

17.50 TL

Tophane Patlıcan Tohumu

17.50 TL

Yeşil Soğan Tohumu

17.50 TL

Enginar Tohumu

17.50 TL

Özel Tohumlar

Sikkas Palmiye

Salkım Akasya

Sünger Kabuk

Çikas Çam

Tütün Tohumu

Pampas Kuru Çiçek



Renkli Taş

1.4 kg



Arıcı Hasır Şapka
02237 9.50 €



Arıcı Mini Maske
02240

Arıcı Tulum Maske
S Beden (Çocuk)
M Beden
L Beden
XL Beden
2XL Beden

04271	16.40 €
04272	16.40 €
04273	16.40 €
04274	16.40 €
04275	16.40 €



Nitril Arıcı Eldiveni Uzun No: 9 - No:10 02031 / 02032 2.60 €

Nitril Arıcı Eldiveni Kısa No: 9 - No:10 02033 / 02034 2.20 €

Nitril eldivenlerimiz deri eldivenlere göre daha hassasır, deri ve vinlex eldivenlere göre daha uzun ömürlü ve uygun fiyatlıdır.



Deri Arıcı Eldiven 02030 5.85 €

Vinleks Arıcı Eldiven 02035 1.95 €

Nitril Takviyeli Arıcı Eldiven No: 9 02056 2.60 €
No:10 02057 2.60 €



Arıcı Standart Ceket Maske		
S Beden (Çocuk)	04261	6.60 €
M Beden	04262	6.60 €
L Beden	04263	6.60 €
XL Beden	04264	6.60 €
2XL Beden	04265	6.60 €
3 Fermuarlı Uzay Maske		
L Beden	02257	9.85 €
XL Beden	02260	9.85 €
Arıcı Çocuk Maske	02259	5.10 €



Arıcı Fonksiyonel Baş Maske
02235 3.10 €



Arıcı Ekstra Ceket Tip Maske	02251	8.20 €
Arıcı Pantolon		
L Beden	02253	5.10 €
XL Beden	02258	5.10 €



Yarım Kollu Arıcı Maske 04254 4.26 €
Arıcı Baş Maske (Kelle) 04250 2.30 €





Arıcı Mont Kıyafet Set (Mont Maske+ Nitril Eldiven)

M Beden	04290	9.20 €
L Beden	04291	9.20 €
XL Beden	04292	9.20 €
2XL Beden	04293	9.20 €

Arıcı Tulum Kıyafet Set (Tulum Maske+ Nitril Eldiven)

M Beden	04300	19.00 €
L Beden	04301	19.00 €
XL Beden	04302	19.00 €
2XL Beden	04303	19.00 €



Arıcılık Seti Standart 6'lık

Toplam 12 Parça	04041	78.96 €
1 adet 6 çerçevelik polen tuzaklı, plastik tabanlı, termo ruşet kovan tek kat çerçevesiz kod:04020		
1 adet arıcı standart mont maske XL kod:04264		
1 adet arıcı nitril eldiven uzun no:9 kod:02031		
1 adet paslanmaz telli arıcı köruk kod:02027		
1 adet el demirli plastik arıcı fırça kod:03058		
1 adet çerçeve tutma pensesi kod:02216		
1 adet küçük el demiri kod:02201		
1 adet paslanmaz telli sır alma tarağı kod:03072		
1 adet 1500gram kutu yemlik gri kod:03106		
1 adet menteşeli ana arı hapsetme kafesi kod:02331		
1 adet kola şişesine uygun arı suluğu kod:02410		
1 adet tokalı kovan kayısı 3 metrelik kod:02154		

Arıcılık Seti Standart 10'luk

Toplam 15 Parça	04042	102.09 €
1 adet 10 çerçevelik polen tuzaklı, plastik tabanlı, termo kovan tek kat çerçevesiz kod:04042		
1 adet arıcı tulum maske XL kod:04274		
1 adet arıcı nitril eldiven uzun no:10 kod:02032		
1 adet paslanmaz telli jumbo arıcı köruk kod:02028		
1 adet el demirli plastik arıcı fırça kod:03058		
1 adet çerçeve tutma pensesi kod:02216		
1 adet galvaniz el demiri kod:02203		
1 adet paslanmaz telli sır alma tarağı kod:03072		
1 adet kayık yemlik gri kod:02404		
1 adet 3 çerçevelik ana arı hapsetme kafesi kod:02073		
1 adet yaylı kırmızı larva transfer kalemi kod:03050		
1 adet büyük pet şişelere uygun arı suluğu kod:02408		
1 adet esnek propolis kapanı kod:02302		
1 adet ana arı ızgarası kod:02301		
1 adet tokalı kovan kayısı 3 metrelik kod:02154		

Bal Dinlendirme Kazanı

430 Kalite

50 Lt - 2 tenekelik	02020	71.40 €
75 Lt - 3 tenekelik	02015	81.60 €
100 Lt - 4 tenekelik	02025	127.50 €
150 Lt - 6 tenekelik	02023	142.80 €



4 Çerçevesi Bal Süzme Makinesi 02026 226.- €
toz boyalı sepet ve ayaklar, 0.5 mm 430 kalite inox gövde, 52.5 cm iç çap, 60 cm dış çap, 70cm yükseklik, 110 cm total yükseklik, metal musluk



4 Çerçevesi Bal Süzme Makinesi 02037 237.50 €
krom sepet ve ayaklar, 0.5 mm 430 kalite inox gövde, 52.5 cm iç çap, 60 cm dış çap, 70cm yükseklik, 110 cm total yükseklik, metal musluk



Bal Süzme Makinesi Dişlisi 02066 46.00 €



Plastik Bal Süzme Musluğu 02963 4.20 €
38 mm

Metal Bal Süzme Musluğu 02964 23.75 €
32 mm
40 mm 02965



Bal Süzme Makinesi Sepeti 46.- €
toz boyalı metal gövde 02055

Bal Süzme Makinesi Sepeti 51.- €
krom kaplama gövde 02054



6 Çerçevesi Motorlu Bal Süzme Makinesi 02036 2161.- €

430 kalite 0.6 mm, paslanmaz, serbest kafa sepet, metal musluk, dadant çerçevelere uygun, sağ-sol çevrilebilir, 220Volt-200 watt motor

6 Çerçevesi Motorlu Bal Süzme Makinesi 02039 2450.- €

304 kalite 0.6 mm, paslanmaz serbest kafa sepet, metal musluk, dadant çerçevelere uygun, sağ-sol çevrilebilir, 220Volt-200 watt motor

4 Çerçevesi Motorlu Bal Süzme Makinesi 576.- €

430 kalite 0.5 mm, paslanmaz sepet, metal musluk, dadant çerçevelere uygun,

4 Çerçevesi Motorlu Bal Süzme Makinesi 720.- €

430 kalite 0.5 mm, paslanmaz sepet, metal musluk, dadant çerçevelere uygun,



02022 - 4 Çerçeveseli Bal Süzme Makinesi DADANT 226.- €

krom sepet, toz boyalı ayaklar, 0.5mm 430 kalite paslanmaz gövde, 52.5cm iç çap, 60 cm dış çap, 70 cm yükseklik, 110 cm toplam yükseklik, metal musluk



02011 - DADANT 6 Çerçeveseli Yatarlı Bal Süzme Makinası 1 290.- €

304 kalite 0.8 mm paslanmaz gövde, 0.8 mm kalınlık, 3 mm kalınlıkta paslanmaz yakalar, tüm cıvata ve bağlantılar paslanmaz, 5 mm çerçeve tutma kolu, 8 mm sepet gövde kolu, 12mm paslanmaz gövde, 4 mm kalınlıkta plastik kapak, 120 cm bacaklarla beraber toplam uzunluk, 64x64x85 cm, 40 kg.



4 Çerçeveseli Bal Süzme Makinesi DADANT 02043

304 kalite 0.6mm , paslanmaz sepet , metal musluk , konik alt kısım sayesinde kolay bal alma, dadant çerçevelere uygun, 70x70 cm dış çap



02038 - DADANT 12 Çerçeveseli Motorlu Yatarlı Bal Süzme Makinası

304 kalite 0.8 mm paslanmaz gövde, 0.8 mm kalınlık, 3 mm kalınlıkta paslanmaz yakalar, tüm cıvata ve bağlantılar paslanmaz, sağ-sol kontrol mekanizmalı, 1000 rpm, 220 Volt or 1000 watt güneş paneline bağlanabilir. 304 kalite 4 mm kalınlık paslanmaz sepet, 8 mm, 5 mm-2.5 mm paslanmaz yatar gövde, center shanks 14 mm, 4 mm pleksi kapak, 40 cm bal musluğunun yüksekliği, 2 adet musluk, 78 cm tank çapı, 130 cm bacaklarla beraber toplam uzunluk, 93x93x96 cm, 66 kg.



Bal Mikseri

304 kalite paslanmaz çift cidarlı gövde, kapakta paslanmaz kulplar, kullanım ve temizlemesi kolay. Termostatlı kontrollü rezistans, paslanmaz çelik mikser 0,37 KW ve 10-50 sirkülasyon, ısı gösterge paneli

70 Lt 02013 1 496.- €

50x50 cm, 70 lt kapasite, 100 kg bal

100 Lt 02014 1 795.- €

60x60 cm, 100 lt kapasite, 140 kg bal

170 Lt 020152

70x70 cm, 170 lt kapasite, 250 kg bal

Syrup Mixers

275 Lt

403 quality

275 Lt

304 quality



Sır Alma Tezgahı Kızaklı 02135

Body 1 mm 304 quality chrome, 304 quality 30x30 1,20 profile with wheel adjustable leg, uncapping aparat 30x30 1,20mm 304 quality profile, 20x40 1,20mm frame aparat profile with wheels, lazer honet knife 2mm 304 quality, water tank with 9 Lt capacity, su haznesi içerisinde 220 V 1000W rheaters and recirculating pump in water tank, hot water piping system

1 Tenekelik Bal Eritme Kazanı
80 Lt 02133 251.- €
0.5 mm tek cidarlı, 304 kalite paslanmaz gövde ve aksesuarlar

Polen Kurutma Makinesi 230.- €

Termostatlı kontrol, düşük enerji tüketimi, 220V, 50-60 kg/gün kapasite, karıştırmaya gerek yoktur.

02131



2 Tenekelik Bal Eritme Kazanı
80 Lt 02136 343.- €
0.5 mm tek cidarlı, 304 kalite paslanmaz gövde

Sırma Alma Tezgah Mekanizması

Polen Kurutma Makinesi Ev Tip

3 kg/day kapasite,
çap: 300 mm, 2.7 kg, 220V

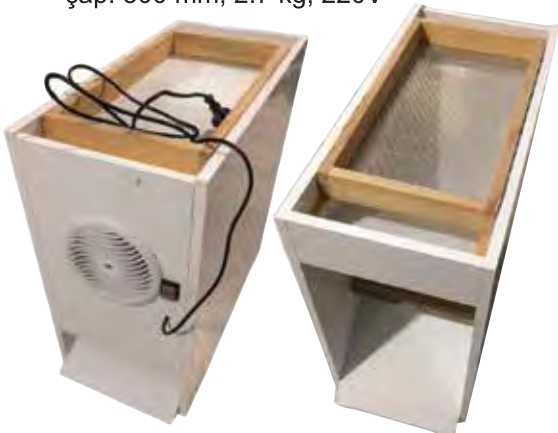

Manuel Sır Alma Tezgahı 02137

Body 1 mm 304 quality chrome, 304 quality 30x30 1,20 profile with wheel adjustable leg, double sided uncapping aparat 304 quality, 304 quality stainer, spherical valve

4 Tenekelik Bal Eritme Kazanı
Çift cidarlı, 0.5 mm 304 kalite paslanmaz çelik gövde ve aksesuarlar

02138

Polen Temizleme Makinesi
62x42x88 cm 02132 140.- €

SF1-a 02952
Elektrikli Çit Sistemi 70.70 €

12.000 Volt, 2 joule, 30 km

SF1-c 02953
Elektrikli Çit Sistemi 85.90 €

12.000 Volt, 4 joule, 50 km, gece mekanizmalı



SF5-B 02954 206.- €

Solar Panel Elektronik Çit Sistemi

2 joule, 10 watt panel, 9 Ah batarya

SF4-B 02955 239.- €

Solar Panel Elektronik Çit Sistemi

2 joule, 20 watt panel, 14 Ah batarya



Elektrikli Çit Sistemi Teli

500 m 02941 72.00 €

1000 m 02942 138.00 €

Plastik İzoleli Tel

500 m - A kalite 03065 21.72 €

500 m - B kalite 03066 11.95 €

Şerit Tel 21.72 €



Plastik İzolatör

A Kalite 02906 0.19 €

Ekonomik 02906A 0.09 €

Plastik İzolatör

(Kablo bağı ile) 0.20 €



Plastik Direk Siyah

100 cm 02908 1.10 €



Çit Sistemi İçin Kapı Sistemi Set

03068 5.65 €



Sıkma Aparatı 03069 0.90 €

Çivi İzolatör 03064 0.10 €



Honey Extractor Motor and Controll Unit 02050A 280.- €

220 volt, 250 watt, motor for honey extractors, suitable to 20 frames extractors, right-left reversable and adjustable speed



Honey Extractor Motor and Controll Unit 02049 232.- €

220 volt, 140 watt, 300 rpm max speed, 2,5 Nm overall torque, 8 Nm max torque, motor for honey extractors, suitable to 4-6 frames manuel extractors, right-left reversable and adjustable speed



Honey Extractor Motor and Controll Unit 02040 158.- €

DC 12 Volt , 90 watt, 300 rpm max speed, 2,5 Nm overall torque, 8 Nm max torque, motor, suitable for 12 V car battery and solar system, right-left reversable and adjustable speed



Solar Honey Extractor Motor Unit

DC 12 Volt , 90 watt, 300 rpm max speed, 2,5 Nm overall torque, 8 Nm max torque, right-left reversable and adjustable speed motor, motor is suitable to 4-6 frames extractor, 55 Ah 12 Volt gel battery, 100 watt solar panel, charger unit



El Demiri Küçük 02201 1.71 €
200x3 mm

El Demiri Büyük 02200 3.55 €

El Demiri Büyük Paslanmaz

Galvaniz El Demiri 02203 2.47 €

El Demiri 02197 5.40 €
Paslanmaz Boyalı

Çekiçli El Demiri 02198 2.55 €

El Demiri Kancalı 02199 6.84 €
Paslanmaz

Mahmuz 02812 2.15 €
260 mm

Çeçeve Bizi 03071 0.93 €
Ahşap Saplı
170 mm (2.5mm)

Çeçeve Bizi 02818 0.85 €
Plastik Saplı
170 mm (2.5mm)

Sır Alma Rulosu 02811 3.50 €

Sır Tarağı 03073 2.00 €
Paslanmaz 20 İğne
Sır Tarağı 03072 2.15 €
Paslanmaz 25 İğne
Sır Tarağı 02816 1.86 €
Çelik İğne



Sır Alma Bıçağı 02823 8.40 €
380 mm
220mm kesme kesmi (32x1mm)

450 mm 02824 30.80 €
290mm kesme kısmı (32x1mm)

Elektrikli Sır Alma Bıçağı 02939 45.40 €

Elektrikli Sır Alma Aleti

Jiletli Sır Alma Tarağı 02819 6.65 €

Ekonomik Model 02819A 5.11 €
Jiletli Sır Alma Tarağı

Çerçeve Tutma Pensesi 02216 2.28 €

Çerçeve Tutma Pensesi 04050 5.20 €
Yaylı

Plastik Saplı Arıcı Fırça 02814 1.76 €
350 mm (200mm)

Ahşap Saplı Arıcı Fırça
440 mm (200mm)
2 sıra fırça 02813 1.80 €
1 sıra fırça 03070 1.40 €

El Demiri Arıcı Fırça 03058 2.90 €
440 mm (200mm) 2 sıra fırça, 5
mm el demir uzunluğu

Jumbo Körük 02028 18.00 €
11x23-34 cm paslanmaz telli
11x23 cm gövde, 11x34 cm
toplam ebat, 0.35mm kalınlık,
12x18 cm vinlex arkalık

Telli Körük 02027 12.51 €
10x20-29 cm paslanmaz telli
10x20 cm gövde, 10x29 cm
toplam ebat, 0.35mm kalınlık,
10x18 cm vinlex arkalık

Korumalı Körük 02001 9.50 €
10x20-29 cm galvaniz,
10x20 cm gövde, 10x29 cm
toplam ebat, 0.35mm kalınlık,
10x18 cm vinlex arkalık

Şarjlı Körük



Profesyonel Ana Arı Üretim Seti

1 jenter set 02080 37.20 €
2 adet 02189 set, 1 adet ana arı
kare gövde



Profesyonel Ana Arı Üretim Seti

3 jenter set 02081 93.00 €



Alüminyum Yumurtalık Rayı

41 cm 02189 8.28 €
4 ray, 4 adaptör, 50 fincan



Yüksük Tabanı 3'ü 1 Arada

Delikli 02085 0.166 €

Yüksük Tabanı 3'ü 1 Arada

Deliksiz 02086 0.166 €



Alüminyum Yumurtalık Rayı

Adaptörü 02087 0.93 €
2 adet set



Süt Alma Şeridi Adaptörü

2 parça set 02091 0.74 €



Süt Alma Şeridi

21 delikli 02118 0.32 €



Ana Arı Yumurtalık Adaptörü

10 delikli 02084 9.30 €
46 adet set



An Arı Üretim Seti 02100 22.32 €

No: 111 dahil değildir.
No: 113-40 adet, No: 114-40 adet,
No: 116-150 adet

No: 113 Yüksük Gövdesi 0.140 €

No: 114 Yüksük Gövde Desteği 0.140 €

No: 115 Kızaklı Yüksük Tabanı 0.230 €

No: 116 Yumurta Fincanı 0.035 €



Ana Arı Yüksük Koruyucu

No: 111 02111 0.18 €



Süt Alma Şeridi Seti 02092 3.07 €

2 adet 30'lu süt yüksüğü
4 adet adaptör



Süt Alma Şeridi

30 delikli, 41cm 02090 0.77 €



Ana Arı Çiftleştirme Kutusu

3 çerçevesi 02500 8.00 €
190x140x140 mm

Çiftleştirme Kutusu Çerçevesi
100x100mm 02508 0.23 €



Strafor Çiftleştirme Kutusu

02507 7.86 €



Strafor Çiftleştirme Kutusu

11 çerçevesi 02509 27.- €



Silikon Ana Arı Yüksük Kalıbı

02191 8.37 €





Ana Arı İşaretleme Kalemı
02703 1.50 €



Larva Transfer Kalemı
03050 0.80 €



Siyah Larva Transfer Kalemı
03051 4.30 €

Sarı Larva Transfer Kalemı
03049 2.50 €



Arı Sütü Alma Kaşığı
02119 1.40 €



Larva Transfer Tığı 02120 4.17 €

Arı Ekmeği Alma Aparatı
02058 5.86 €



Queen Bee Pipe Catcher

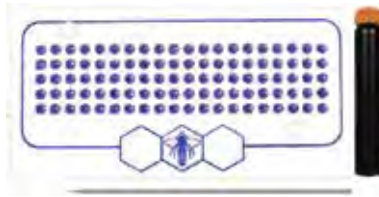

Ana Arı İşaretleme Seti 14.53 €
kırmızı-yeşil-mavi-beyaz-sarı
100 numaraya kadar
02082/02083/03077/03078/03079



Ana Arı İşaretleme Yapışkanı 3.80 €



Ana Arı İşaretleme Tüpü
02117 4.70 €



Ana Arı Yakalama Tokası
02129 1.00 €



Pratik 03055 2.20 €
Ana Arı Yakalama Aparatı

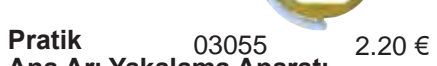

Ana Arı Memesi Hapsetme
53 mm 02123 0.21 €
105 mm 03075 0.39 €



Ana Arı Kafesi Kırlangıç 02122 0.17 €
Ana Arı Kafesi 03074 0.17 €

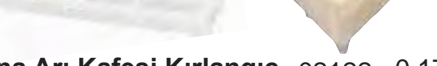
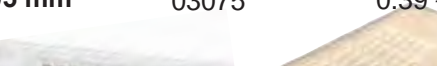
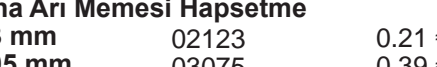

Suni Tohumlama Cihazı
02101 1 300.- €

Cihaz 03080 778.- €
Karbondioksit Tüp 03081 117.- €

Mikroskop 03082 386.- €
Işık 03083 22.60 €

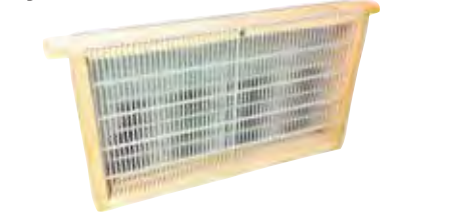

Ana Arı Hapsetme Kafesi
Tek çerçeve 02071 3.83 €



Ana Arı Hapsetme Kafesi
2 çerçeve 02072 3.27 €
3 çerçeve 02073 3.65 €

Menteşeli Ana Arı Hapsetme
Izgarası 02331 2.00 €
500x170x458x27 cm

Ana Arı Memesi Muhafaza
Aparatı 02110 0.14 €

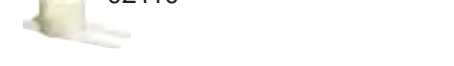
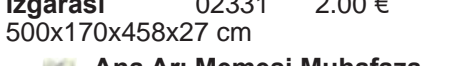



Ana Arı Çiftleştirme Kutusu
Tek Katlı 03001 23.00 €
4 çerçeveseli, 2 kayık yemlik, ön ve arka uçuş tahtalı, altıgen arı girişi, 25cm en, 29cm boy, 31cm yükseklik, 5kg

Çift Katlı 03002 41.00 €
4 çerçeveseli, 2 kayık yemlik, ön ve arka uçuş tahtalı, altıgen arı girişi, 27cm en, 29cm boy, 60cm yükseklik, 8kg



Ruşet Mini TurboYemlik
25.5x21.5x11 cm 02275 1.50 €



Ruşet Mini Kayık Yemlik
6 cm 02276 0.70 €
26.2x22.5x22x5 cm



Ruşet Mini DerinYemlik
15 cm 02277 0.70 €
26.2x22.5x22x5.5 cm



Seleksiyon Çerçeve
22.5x22cm 02278 1.12 €



Polen Kapanı
340x90 mm 02700 7.45 €



Alüminyum Polen Alt Izgarası
170x270 mm 02307 0.95 €



Polen Kapanı Izgarası (yuvarlak delikli) 1.25 €
170x270 mm
4.8mm delik çapı
02306

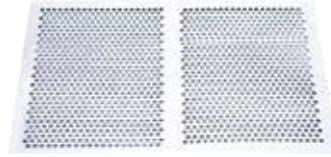

Alüminyum Polen Izgarası
340x270 mm 02305 2.50 €



Plastik Polen Izgarası
170x270 mm, 02314 0.50 €
5.2mm delik çapı



Polen Kapanı Geçiş Izgarası
45x320 mm 02308 0.50 €

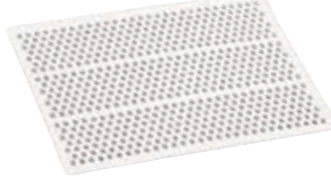

Plastik Polen Izgarası
170x270 mm, 02312 0.50 €
4.8mm delik çapı



Polen Kapanı Alt Izgarası
180x280 mm 02313 0.50 €



Polen Çekmecesi
220x320 mm, 02311 0.75 €
20mm derinlik



Plastik Kovan Kapağı
41x48.5x6.5 cm 02095 6.60 €
(46.5x54x9 cm)



Termo Kovan Kapağı - 10 çerçeve
51.5x43.5x7 cm 02270 9.75 €

Termo Kovan Kapağı - 6 çerçeve
51.5x43.5x7 cm 02270A 8.40 €



Ruşet Kovan Tabanı Set - 6 Çerçeve
02505 8.40 €



Arı Kaçırıcı 02531 1.07 €



Ayarlı Arı Girişi
305x40 mm 02518 0.79 €



Ayarlı Arı Girişi
420x45 mm 03087 0.92 €



Ekonomik Ayarlı Arı Girişi
196x32 mm 03088 0.45 €



Dik Arı Girişi
95x32 mm 02806 0.38 €



Plastik Kovan Daraltma Tahtası
485x265 mm 02330 2.25 €



Termo izole Plastik Kovan
Tek Kat, 10 Çerçeve
50x44x43 cm 04011 47.- €

Termo izole Plastik Kovan
Çift Kat, 10 Çerçeve
50x44x69 cm 04012 67.- €



Termo izole Plastik Ruşet Kovan
Tek Kat, 6 Çerçeveli
50x44x43 cm 04020 42.- €

Termo izole Plastik Ruşet Kovan
Çift Kat, 6 Çerçeveli
50x44x69 cm 04021 60.- €

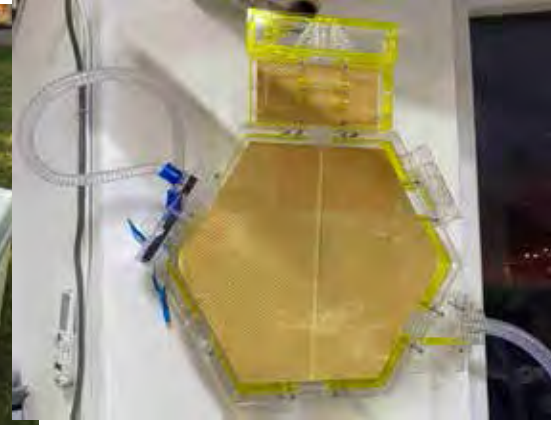

Akvaryum Kovan
04009 460.- €



Ayarlı Kovan Uçuş Tahtası
30.5x13 cm 02802 1.35 €



10 Çerçevelik Termo Kovan Duvarı
Tek Kat 04013 21.86 €

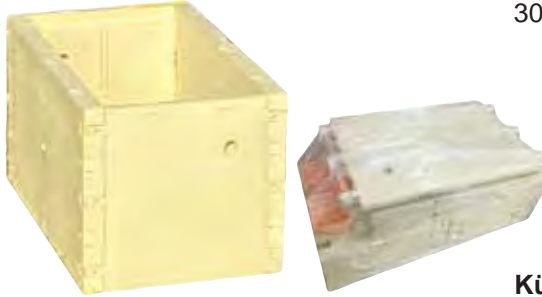

6 Çerçevelik
Termo Ruşet Kovan Duvarı,
Tek Kat 04023 19.43 €



Küçük Kovan Uçuş Tahtası
20x11 cm 02803 0.95 €



10 Çerçevelik Termo Kovan Duvarı
Çift Kat 04014 42.51 €



6 Çerçevelik
Termo Ruşet Kovan Duvarı,
Çift Kat 04024 38.87 €



Mini Kovan Uçuş Tahtası
10x6 cm 02271 0.57 €

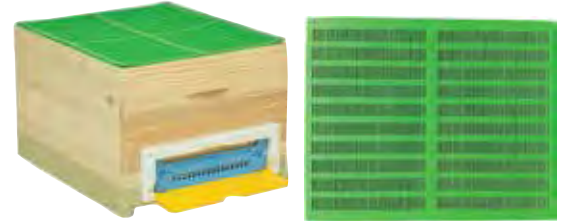

Propolis Kapanı
495x415x2.5 mm 02302 1.70 €



3'lü Kombi Çiftleştirme Kutusu
3'lü Çiftleştirme Kutusu olarak
kullanılabilen 04031 61.- €
Termo İzole Ruşet Kovan
9 seleksiyon çerçeve, 3 yemlik ile
beraber 3 bölme çiftleştirme kutusu



Polen Tuzaklı 02070 12.- €
Plastik Kovan Tabanı
500x400x80mm dış ölçü
455x375 mm iç ölçü

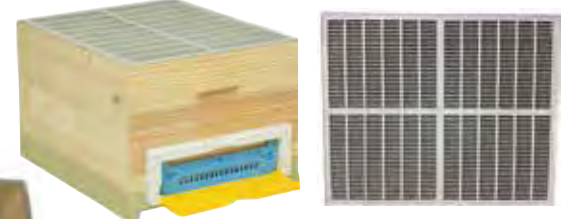

Ana Arı Izgarası
500x410x2.5 mm 02301 1.30 €

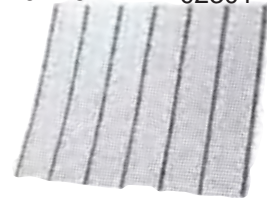

Metal Ana Arı Izgarası
41x50 cm 02301A 7.00 €



Arı Kolonisi Plastik Taşıma Kafesi 04035 18.50 €

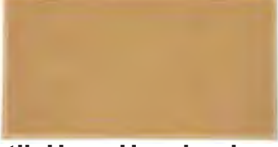

Plastik Hazır Havalandırmalı Petek 02563 4.40 €
425x212 mm



Kabartılmış Plastik Petekli Pratik Çerçeve 02567 4.70 €
485x235 mm



Plastik Hazır Petekli Pratik Çerçeve 02560 4.62 €
483x232 mm

Plastik Hazır Petekli Pratik Çerçeve Erkek Arı Gözlü 02561 4.62 €



Kabartılmış Plastik Petek İşçi Arı Gözlü 02564 2.40 €
Dadant 425x280 mm



Kabartılmış Plastik Petek İşçi Arı Gözlü Langstroth 02565 2.00 €
425x213 mm



Plastik Hazır Havalandırmalı Petek Pratik Çerçeve 02568 5.10 €
483x232x33 mm



Kabartılmış Plastik Petek Erkek Arı Gözlü 02566 2.60 €



Kovan Kilidi Ayarlı 02334 0.60 €

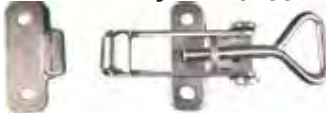

Kovan Kilidi A Model Ayarlı 02333 1.45 €



Kovan Kilidi D Model Ayarlı, ekonomik 02333A 1.45 €



Kovan Kilidi Kulplu 02211 3.80 €



Ayarlı Kovan Kilidi 02212 2.21 €



Kovan Kilidi D Model Ayarlı, yıldızlı 02213 2.55 €



Karakovan Çerçevesi 02516 3.70 €
440x250x26 mm



Karakovan Kasnağı 02709 1.35 €
750x26x2 mm



Plastik Kovan Çerçeve 02515 3.15 €
440x250 mm
445x230 mm (4 bölme) 02521 3.15 €
440x160 mm (4 bölme) 02522 2.90 €



Kovan Kapak Kilidi (10 Adet) 02210 5.30 €



Ayarlı Yuvarlak Arı Girişi 02125 0.12 €
70x75mm, 55 mm iç çap



Yuvarlak Arı Girişi 02124 0.09 €



Kovan Kulbu 02202 0.56 €
5 mm



Kovan Kulbu 02204 1.55 €
7 mm

Mim Mandal

40 mm 02219 0.10 €
50 mm 02220 0.10 €



Uçuş Tahtası Yayı 02218 0.12 €



Katlanır Çerçeve Menteşesi 02221 0.93 €





Petek Yapıştırma Aparatı 41.00 €
02440



Petek Yapıştırma Trafosu 25.00 €
02441



Metal Çerçeve Delici 6.05 €
02408B



Çerçeve Delici Ahşap 2.33 €
02048

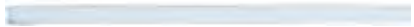

Kovan Denge Sacı 0.25 €
370 mm (1 adet) 02127



Kovan Denge Sacı 10 Bölmeli 0.28 €
370 mm (1 adet) 02126



Mum Eritme Cezvesi 6.51 €
03097

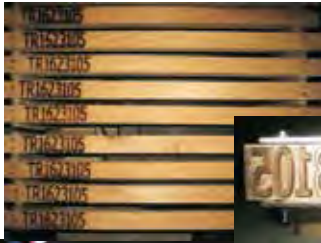

Çerçeve - Kovan 131.- €
Damgalama Aparatı 02061

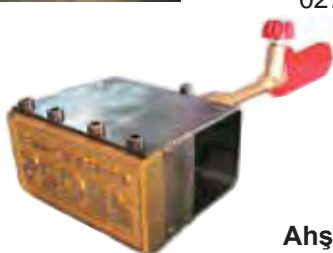

Ahşap Çerçeve Çıtası 0.57 €
Langstroth 02980
Dadant 02981 0.57 €



Galvaniz Çerçeve Teli
200 gr - 0.50 mm 02444 0.94 €
500 gr - 0.50 mm 02445 2.15 €
1000 gr - 0.50 mm 02446 3.04 €
2000 gr - 0.50 mm 02446A 7.85 €
10 kg kangal (kg fiyatıdır) 02979 2.80 €



Paslanmaz Çerçeve Teli
200 gr 02975 3.80 €
500 gr 02976A 7.79 €
1000 gr 02276 15.20 €

10 kg Makara (kg fiyatıdır) 02978 2.80 €



Kuşgözü
5000 gr 02449 10.00 €
10000 gr 02449A 19.00 €



Çıta Delme Makinası 95.00 €
Elektrikli 02047
Aynı anda 4 delik açmayı sağlar.
Matkap hariçtir.



Makaralı Çerçeve Tel Germe Aleti 24.65 €
02724



Ahşap Çerçeve Çıtası 0.57 €
Langstroth 02980
Dadant 02981 0.57 €



Çerçeve Delme Makası
5 delik 02710 49.00 €
7 delik 02711 53.00 €



Tel Germe Mengenesi (Vidalı) 7.50 €
02720



Tel Germe Aparatı 7.41 €
02721



Çerçeve Tel Germe Aleti Sac Plakalı 24.65 €
02723



Makara Tel Tutma Aparatı 4.00 €
02447



Tel Gerdirci 2.60 €
02817



Makara Tel Tutma Aparatı 4.00 €
Büyük makaralar için 02450



Plastil Bal Süzgeci 02809 1.23 €



Bal Hunisi 02822 8.40 €
Paslanmaz, 20 cm



Bal Hunisi 02808 6.10 €
Paslanmaz filtre ve süzgeçli

Paslanmaz Bal Filtresi 02810 3.10 €



Bal Süzgeci 18 cm 02820 13.00 €
23 cm 02820B 15.50 €



Plastik Sır Alma Kabı 02420 35.50 €
Şeffaf



Plastik Mum Toplama Kabı Siyah 02422 8.40 €
620x440x180 mm

Plastik Mum Toplama Kabı Şeffaf 02421 14.00 €
620x440x180 mm



Bal Taşıma Sandığı 02424 10.45 €
370x500x270 mm
Lanstroth uygun



Dozajlı Bal Dolum Pompası 04510 2400.- €



Bal Dolum Pompası 04511 1800.- €



Balmumu Sıkma Presi 04531 2430.- €
50 kg, 220 Volt



Kovan Çerçeve Askısı 02443 4.00 €



MAY 120 05020 0.15 €

Plastik Bal Kabı
109x137x27 mm- 220cc, 600 pcs/kutu,
Kutu ebat: 450x450x160 mm

MAY 130 05025 0.25 €

Plastik Bal Kabı
127x171x27 mm- 335c, 450 pcs/kutu,
Kutu ebat: 400x500x160 mm

MAY 140 05030 0.29 €

Plastik Bal Kabı
138x186x27 mm- 420cc, 450 pcs/kutu,
Kutu ebat: 440x570x165 mm



MAY 230 05035 0.36 €

Plastik Kapaklı Bal Kabı
87x120x48 mm- 250cc
380 pcs/kutu,
Kutu ebat: 400x580x495 mm

MAY 240 05040 0.55 €

Plastik Kapaklı Bal Kabı
117x155x48 mm- 530cc
210 pcs/kutu,
Kutu ebat: 400x580x496 mm



MAY 265 05045 1.48 €

Plastic Kapaklı Bal Kabı
228x56 mm- 1520cc, 80 pcs/kutu,
Kutu Ebat: 475x475x530 mm



720cc Cam Kavanoz 39903 0.35 €
(1000 gr bal),
82 mm iç çap,
30 adet paket naylon ambalajlı

660cc Cam Kavanoz 39902 0.34 €
(850 gr bal),
82 mm iç çap,
30 adet paket naylon ambalajlı

370cc Cam Kavanoz 39901 0.27 €
63 mm iç çap,
24 adet paket naylon ambalajlı

190cc Cam Kavanoz 39900 0.21 €
(250 gr bal),
53 mm iç çap,
28 adet paket naylon ambalajlı

49cc Cam Kavanoz
43 mm iç çap,
28 adet paket naylon ambalajlı



Kapaksız Turbo Yemlik

508x426 mm - 55 mm derinlik
Şeffaf 02399 5.10 €
Gri 02400 4.20 €



Kapaklı Turbo Yemlik

500x410 mm - 515x425 mm, 5 Lt
Şeffaf 02401 6.05 €
Gri 02401B 5.10 €



Kayık Yemlik

485x110 mm
Şeffaf 02403 1.03 €
Gri 02404 0.70 €



Kutu Yemlik

1500 gr - 263x180x46 mm
Şeffaf 02405 2.09 €
Gri 03106 1.05 €

Kutu Yemlik

1200 gr - 260x185x40 mm
Şeffaf 02406 1.52 €
Gri 03105 1.05 €

Kutu Yemlik

3500 gr - 250x485 mm
Şeffaf 03104 3.99 €
Gri 03107 2.28 €



Bölme Yemlik

250x485 mm
Şeffaf 02402 2.35 €
Gri 02402A 1.65 €



Arı ve Tavuk Suluğu

3 Lt 02322 4.20 €
5 Lt 02323 4.50 €
10 Lt 02321 7.10 €



Arı Suluğu

02408 1.33 €



Kavanoz Yemlik

02407 1.35 €



Arı Tutma Aparatı

02417 0.41 €



Suluk ve Şurupluk

Pet şişeye uyumlu 02410 1.70 €
Kare Suluk ve Şurupluk 02429 0.60 €

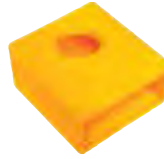

Arı Suluğu

Damacanaya uyumlu

02409 1.60 €



Damacana Standı

Küçük 02411 4.20 €
Büyük 02414 4.20 €



Kovan Dışı Branda Örtü

02244 2.00 €



Kovan Örtüsü

53x60 cm 02245 0.71 €
60x70 cm 02246 0.85 €
Pamuklu 02245A 0.84 €
Suni Deri 02245B 1.06 €



Kemirgen İstasyonu

02425 1.10 €



Flow Hive Cells



Eşek Arı Kapanı

02530 2.52 €



Eşek Arı Kapanı

Cam Kavanoza Uyumlu 02525 0.95 €



Propolis Sabun 03204 1.90 €



Ballı Sabun 03205 1.90 €



Polenli Sabun 03206 1.90 €



Lavanta Sabun 03125 1.90 €



Propolis Ekstrat 03124 66.50 TL
GOLDBEE
Propolis Ekstrat 60.00 TL



Arı Sütü 03225 475.- TL



Kestane Balı 850 gr 03209 470.- TL

Çiçek Balı 850 gr 03208 190.- TL

Çam Balı 850 gr 03211 200.- TL

Ayçiçek Balı 850 gr 03214 190.- TL

Kestane Çam Balı 850 gr 470.- TL

Krem Çiçek Balı 850 gr 03213 190.- TL

Hayıt Balı 850 gr 200.- TL

Okaliptüs Balı 850 gr 200.- TL



Toz Propolis 40 gr 2.53 €

Kuru Polen 200 gr 3.17 €



Kavanozlar için Strafor Köpük
1 kavanozluk 04070
2 kavanozluk 04080
4 kavanozluk 04090



Ahşap Bal Kaşığı 15-18 cm uzunluk 01910 0.60 €



Balmatik Bal Dispanseri 02103 330.- €



Bal Kavanoz Pompası 03120 4.30 €



Probiyotikli Arı Kovanı Hijyen Solüsyonu 03500



BEEAGRA 02995 1.00 €
Arı Vitamini
100 gr

- Health and vitality powder for bees.
- It helps queen bee produce more eggs.
- It develops more effectively immune system.

- It furthers brood brood production and ensures strong, healthy and productive colony.

*To increase the reproduction activity of the queen bee.

*To increase the strenght of bees and help their heathy growing.

*By providing healthy colonies, to reach the high honey efficiency.

*In Fall, helps colonies to be strong for the winter season and to stay strenghtfull against illnesses.

Mix at the rate of 100 gr into 50 kg bee food or bee syrup.



Ana Arı Çekme Spreyi

02195 0.95 €



MG 15 02062 115.00 €
Oksalik Asit Buharlaştırma Aparatı



Oksalik Asit Buharlaştırma Aparatı Tekli 02059 58.00 €



Oksalik Asit Buharlaştırma Aparatı 6'lı 02060 210.00 €



MG 15 K Tekli Kartuşlu Yaylı Asit Buharlaştırma Aparatı 03150



MG 10 K Tekli Kartuşlu Oksalik Asit Buharlaştırma Aparatı 03155 58.00 €



POLLENBEE 02996 1.40 €
100 gr

- Health and vitality powder for bees.
- It develops more effectively immune system against diceases.

- It helps queen bee produce more eggs.
- The addition of powder will benefit colonies healthy supplement and feed bees for winter months.

- It furthers brood brood production and ensures strong, healthy and productive colony.

- High quality honey.
- Reduces bee deaths.

- It futhers brood production and ensures a strong, healthy and productive colony.

- Increase vitamins

- Does not contain glucose, gluten and oil. This is not a medical supplement, not used for treatment. it does not left any remains on honey. Does not mix with hot syrup.

Mix at the rate of 100 gr into 50 kg bee food or bee syrup.



BEENERAL 02994 1.10 €
100 gr

It helps queen bee produce more eggs. It develops more effectively immune system against diceases.

Ot helps growth of bees fast.

High quality honey

Reduces bee deaths.

Make bees stronger against nousema.

Mix at the rate of 100 gr into 50 kg bee food or bee syrup.



VARRODONA Sıvı Premiks
250 ml 2.35 €
1 Lt 7.45 €
5 Lt 33.50 €



Schutz Oğul Yakalama Spreyi
02192 6.65 €



Ölçekli Sulu Oksalik Asit Uygulama Aparatı 02537 5.70 €



Formik Asit Uygulama Kabı
02535 0.13 €



Pet Şişeye Uyumlu Sprey 02539 3.35 €



Formik Asit
1 Lt 02982 6.35 €



Oksalik Asit
1 Kg 02983 5.90 €

Gliserin
1 Kg 02990 5.33 €



Yuvarlak Arı Kovanları
8 Çemberli Çam
17 Çemberli Çam
17 Çemberli Eskitilmiş Çam
Yuvarlak Karakovan Çerçevesi
Karakovan Örme Sepet

01959 53.20 €
01960 87.80 €
01962 117.00 €
01963
01964 18.00 €



Arıcı Ocağı

01991



Battery Fog Machine
for liquids

02042



Otomatik Yemlik

02002



Propan Burner 271850 7.46 €



Kovan Kayışı Tokalı

3 mt 02154 (02214) 1.75 €
5 mt 02156 (022157) 1.90 €



Kovan Kayışı Cırcır Mekanizmalı

3 mt 022158 3.70 €
5 mt 022159 4.00 €



Kovan Kapağı Stop

03056

0.08 €



Kapaklı Kovan Havalandırma

02132 A

0.33 €



Sepet Kovan
500x500 mm

02931

8.85 €



Plastik Kovan Ayağı
(2 Adet)

02900

3.35 €



Plastik
Kovan Numarası

02533

0.34 €



Metal
Kovan Numarası

02534

0.95 €